

Comprehensive
Catalogue

2006



Susol
Super Solution

**Contactors and
Overload relays**

LS Industrial Systems
www.lsis.biz

The Challenges and Growth achieved by LG
will continue with New Will of LS Industrial Systems.

**New Name of LG Industrial Systems,
New Take-off for LS Industrial Systems**

LS Industrial Systems

To advance to the next level,
LG Industrial Systems is reborn as LS Industrial Systems.
LS Industrial Systems will continue to lead the future
of industrial electrics and automation by providing
Total Solution, a core essential
for competition in the 21st century industrial era.



Research & Development

We provide differentiated values.

The world-class Power Testing & Technology Institute guarantees certified products and global brands.

The PT&TI is an accredited testing laboratory that provides a worldwide testing service with a 1500MVA-capacity High Power Laboratory, a High Voltage Laboratory, and a Reliability Testing Laboratory. Its testing has been fully acknowledged and recognized by overseas testing certification bodies, such as KEMA of Netherlands, UL of USA, and CE of the EU for its low voltage testing.



Global technology and R&D are behind the best industrial Electric power and automation products from LSIS

Quality Test at PT&T



High Voltage Test / Impulse Test



Characteristics Test / VCB Characteristics Test

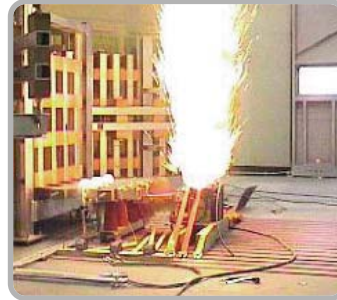

Short-Circuit Test / ACB Short-circuit Test



Environmental Test / Non-stop High Temperature Test

Electro Technology R&D Center

The Electro Technology R&D Center focuses on overall research and development activities related to power supply systems such as low and high voltage equipment as well as integrated digital networks, automatic switchboards and integrated power protection.

The R&D Center maximizes energy efficiencies by integrating rapidly developing information & technology, communication, electronics and mechanical engineering, while concentrating its efforts in creating a safe and pleasant industrial environment.

● Power Equipments

The R&D Center researches products and technologies related to low and high voltage circuit breakers and contactors as well as power transmission & distribution.

● Electric Technology

The R&D Center analyzes and researches core technologies related to power equipment.

● SCADA

The R&D Center carries out projects and technology research in the fields of SCADA and DAS.

● Simulator

The R&D Center predicts probable electrocution hazards by conducting simulated analyses of power generation phenomena, and develops simulation technologies and products that can optimize the constituent facilities.

Power Testing & Technology Institute

PT&T is a KOLAS-qualified (Korea Laboratory Accreditation Scheme) accredited testing laboratory and provides worldwide testing service with its 1500MVA-capacity High Power Laboratory, High Voltage Laboratory and Reliability Testing Laboratory.

PT&T is also fully recognized by foreign testing and certification bodies of high reputation as CESI of Italy, KEMA of Netherlands, UL of America, etc. for its low voltage testings.

● Available Tests

- Electro-Mechanical Tests
- Insulation Performance Tests
- Short-Circuit Tests
- Reliability Evaluation Tests
- Arc Tests
- Environmental Tests

● Research & Development

Testing Technology, Measuring & Analyzing Technology, Power Equipment Monitoring & Diagnostic Techniques, Reliability Testing & Evaluation Technology.

A man in a dark suit, white shirt, and patterned tie is smiling and clapping. He is wearing round glasses. In the background, another man in a suit is also clapping. The scene is dimly lit, suggesting an indoor event or ceremony.

Quality & Service

**Advanced Technologies &
Up-to-date Production Capabilities**

**To accomplish its goal of becoming a global supplier,
LS Industrial Systems has employed greater human resources and
materials efficiently for rapid and flexible operational capacity.**

Customer Satisfaction through Quality & Service

The best products come from LSIS

In order to provide the best quality products and services, LSIS not only has obtained the ISO9001 certificate but also implemented the TCS (Total Certification Service) program to help other affiliated companies to acquire the ISO9001 mark. We place the highest priority on delivering the best quality for complete customer satisfaction.

Quality is the basis for customer satisfaction

LSIS is implementing the 6-Sigma program with the goal of 'zero-defect' to make only the highest quality products. And to secure product reliability, we embody a high quality guarantee system by carrying out product test evaluations that are internationally recognized for their use of the most current technology.



A place for learning the most advanced technologies

The LSIS' training center is conducting customer technology training for industrial system industry in Korea for the first time. The technical training center is currently giving lessons in the fields of factory automation, industrial electric power and electronics with real practice equipment while providing high-tech services through technical consulting and guidance.



Training Center Auditorium



Technical Training Classes



Product Exhibition Hall

Customer service is available anywhere in the world

LSIS offers web-based customer services anywhere in the world. We provide technical information, prompt Q&A's and accurate history of maintenance through our web service. We have established the Supply Chain Management System that embodies the integrated management of acquisition, production and sales, and we are now leading e-business in the areas of industrial electric power and automation.



<http://www.lsis.biz>



Call Center

Solution provider

You can count on us.

New Face & New Resolution To become a global leader that gives top priority to customer values

We promise you that LSIS will be reborn as a corporation that returns the best values to its customers.

We are committed to global product development, driving future growth, and expanding the overseas market share, as well as consolidating existing business.

Join us in a future where LS Industrial Systems will become a genuine global leader.



Customer satisfaction with world-class products and services: LS Industrial Systems is committed to excellence!



Cheongju Plant (Korea)



Dalian Plant (China)



Hanoi Plant (Vietnam)



Wuxi Plant (China)

Electric Power Industry

Electric Equipment & Systems

The electric equipment and systems of LS Industrial Systems, ranging from low to high voltage products, have not only acquired ISO 9001 and 14001 certification for their efficient design and excellent quality, but many other certificates, including KEMA, TÜV, CESI, ASTA, and KERI. The outstanding quality of the products that we are manufacturing conforms to international standards such as IEC, UL, ANSI, CCC, JIS, and KS.

We also provide Total Solutions that encompass customized designs and more advanced technology, as well as efficient production and installation, and highly accurate testing and analysis of power equipment.



Chonan Plant (Korea)



Wuxi Plant (China)

Automation Industry

Automation Equipment, Industrial IT & RFID

LS Industrial Systems, a leading pioneer of the domestic automation business, developed the first ever PLC, Inverter (AC Drive), and DCS in Korean automation history. We now provide Total Solutions through the diverse application of our own products, ranging from controllers to control systems that are based on sophisticated technology and proven experience, to bring innovative change to distribution systems and logistics.



Janghang Plant (Korea)

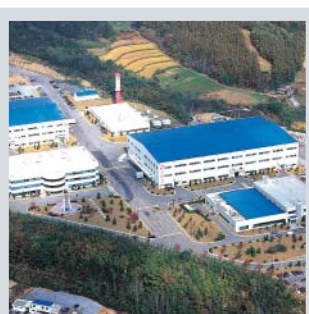

Chonan Plant (Korea)

Industrial Equipment Industry

Metal Processing & Electric Power Tools

In addition to supplying basic industrial material, such as copper tubes and STS pipes to the electronics and chemical industries, LS Industrial Systems also manufactures and supplies electric power tools that have been recognized for their excellent performance capabilities in over 38 countries.



Susol Contactors



Super Solution Contactors



Susol Contactors

LSIS SUPER SOLUTION CONTACTOR

Contents :



B-1. Contactors	Specifications	B-1-1	
	3-pole contactors	B-1-3	
	Reversing contactors	B-1-9	
	Control circuit characteristics	B-1-11	
	Auxiliary contacts/contact blocks characteristics	B-1-12	
	Accessories	B-1-13	
B-2. Overload relays	Specifications	B-2-1	
	Characteristics class 10A	B-2-3	
	Characteristics class 20	B-2-5	
	Accessories	B-2-7	
	TOR Tripping characteristics	B-2-9	
B-3. Manual motor starters	Specifications	B-3-1	
	Selection guide	B-3-3	
	Accessories	B-3-6	
	Technical information	B-3-9	
B-4. Overall dimensions	Contactors	B-4-1	
	Motor starters (Screw type)	B-4-4	
	Motor starters (Lug type)	B-4-5	
	Reversing contactors and starters	B-4-6	
	Manual motor starters	B-4-9	
	Combination Manual motor starters and contactors	B-4-13	
	Overload relays (Screw type)	B-4-15	
	Overload relays (Lug type)	B-4-16	
	Separate mounting units for overload relays (Screw type)	B-4-17	
	Separate mounting units for overload relays (Lug type)	B-4-18	
	Circuit diagram	B-4-19	
	B-5. Technical information	Standards	B-5-1
		Definitions	B-5-2
Certifications and approvals		B-5-6	
Utilization categories		B-5-9	
Average full-load currents of 3-phase squirrel cage motors		B-5-13	
Making and breaking conditions		B-5-14	
General technical data		B-5-16	
Application guidance		B-5-24	
Type-2 coordination		B-5-45	
B-6. Catalogue numbers	Contactors	B-6-1	
	Overload relay	B-6-64	
	Accessories	B-6-69	
	Maunal Motor Starters	B-6-74	



Susol

Super solution



• **Super** Performance

• **Super** Breaking capacity

• **Super** Optimum coordination

• **Super** Extensive applications

Top-Class Contactor Family



Contactors & Overload Relays

LSIS contactor/overload relay meets IEC, UL, CSA, CCC and CE standards, it is the perfect product solution for applications all over the world. Including non-reversing and reversing contactors and starters as well as overload relays and accessories, contactor/overload relay brings LSIS to a whole new level.

The space saving and easy-to-install MC contactors and starters is the efficient and effective solution for customer applications from 9-95A. Enclosed control options include metallic and non-metallic enclosures.

Only three frame sizes cover contactor ratings up to 95A, making it easier for OEMs to lay out panels. With a broad line of application specific designs, contactor/overload relay allows customers to select the right tool for the job.



Susol Contactors

■ **Leading Solution**

- Small size, big expectations
- World class with UL, CSA, CE and CCC approvals
- Easy to install
- Safe and simple to work
- Improved environmental performance
- Comprehensive range of accessories





“Provides total support in the of form dedicated”

■ Limitless Satisfaction

LS provides total support in the form of dedicated resources, highly developed technologies, highly trained manpower and internationally recognised standards.

The new range of motor control apparatus is supported by technical documentation, drawing standards and design guides. This, with improved marking and more compact size, makes it easier than ever to integrate our products into your projects.

Contactor rating

Type	AC3 duty 440V	Ith
MC-9	4kW 9A	25A
MC-12	5.5kW 12A	25A
MC-18	7.5kW 18A	40A
MC-25	11kW 25A	40A
MC-32	15kW 32A	50A
MC-35	18.5kW 35A	55A
MC-40	18.5kW 40A	60A
MC-50	22kW 50A	70A
MC-63	25kW 63A	75A
MC-65	30kW 65A	100A
MC-75	37kW 75A	110A
MC-85	45kW 85A	135A
MC-95	45kW 95A	140A

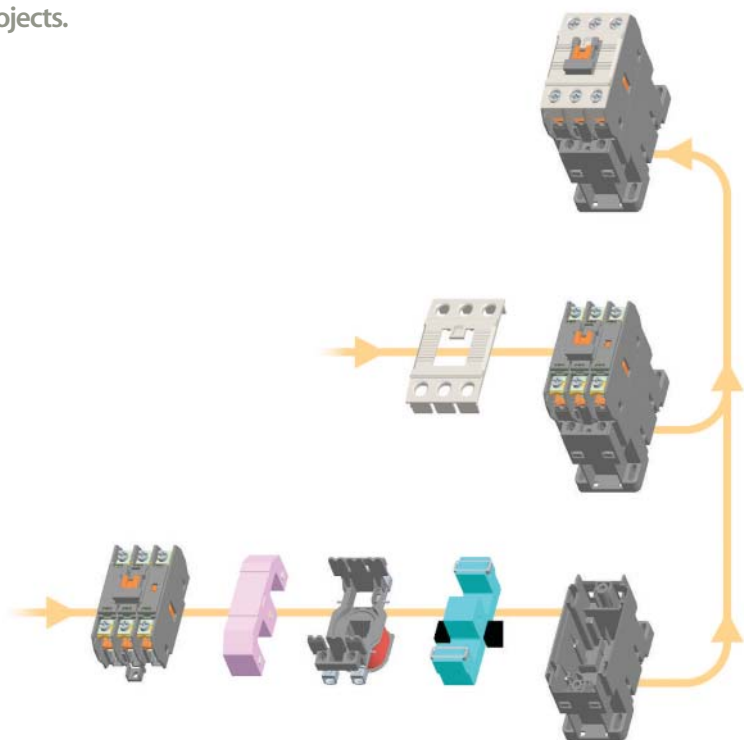

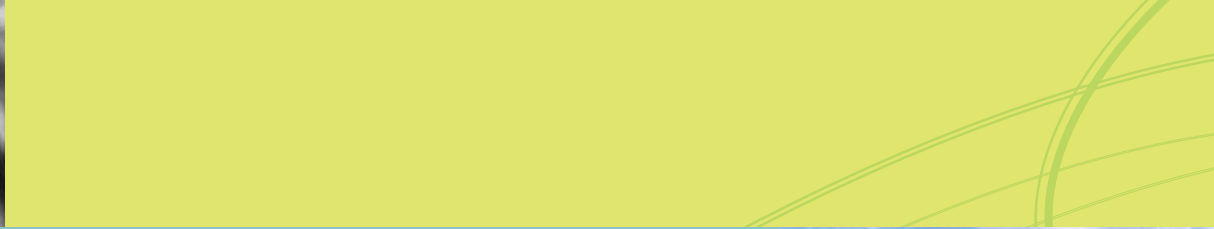

*Compact design and
the most-effective solutions for the motors*

Susol Contactors

Combination with Manual Motor Starters

The perfect solution to reducing the installation time of panel controls.

- DIN rail mounting adapter
- Easy to combine by using adapter and wiring kit
- Space saving
- Removing contactor easily
- Finger-proof wiring links



Combinations

Manual Motor Starter		Contactor
Type	Setting range	Type
MMS-32	0.1~32A	MC-9
		MC-12
		MC-18
		MC-25
		MC-32
MMS-63	6~63A	MC-35
		MC-40
		MC-50
		MC-63
MMS-100	11~100A	MC-65
		MC-75
		MC-85
		MC-95



■ Combination with Overload Relays

The space-saving and easy-to-install contactors and overload relays are the efficient and effective solution for customer applications up to 95A.

Combinations

Overload Relay		Contactor
Type	Setting range	Type
MT-32	0.1~32A	MC-9
		MC-12
		MC-18
		MC-25
		MC-32
MT-63	4~65A	MC-35
		MC-40
		MC-50
		MC-63
		MC-65
MT-95	7~95A	MC-75
		MC-85
		MC-95
		MC-95
		MC-95



LS Meta-MEC Manual Motor Starters provide completed ranges up to 100A



32AF

63AF

32AF

0.1~0.16... 22~32A (16 step)

MMS-32S



Standard

**MMS-32H
MMS-32HI**



High break
Magnetic release

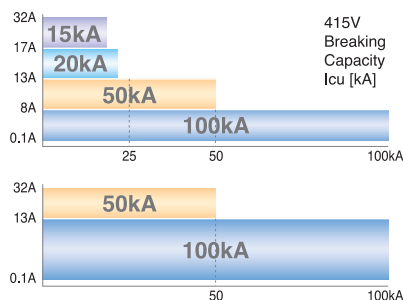

6~10... 45~63A (9 step)

MMS-63S



Standard

**MMS-63H
MMS-63HI**



High break
Magnetic release

up to 100A



MMS

100AF

63AF

100AF

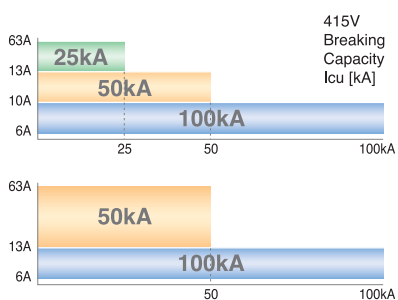

11~17... 80~100A (10 step)

MMS-100S

Standard

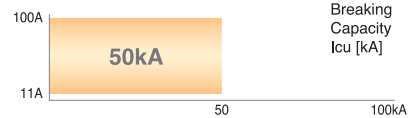

MMS-100H
MMS-100HI

High break
Magnetic release

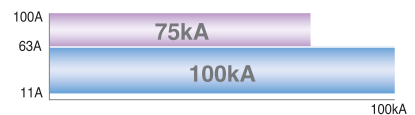

LS Meta-MEC Manual Motor Starters deliver more efficiency through various functions and compact design

MMS-32H... 32A [Scale 1:1]

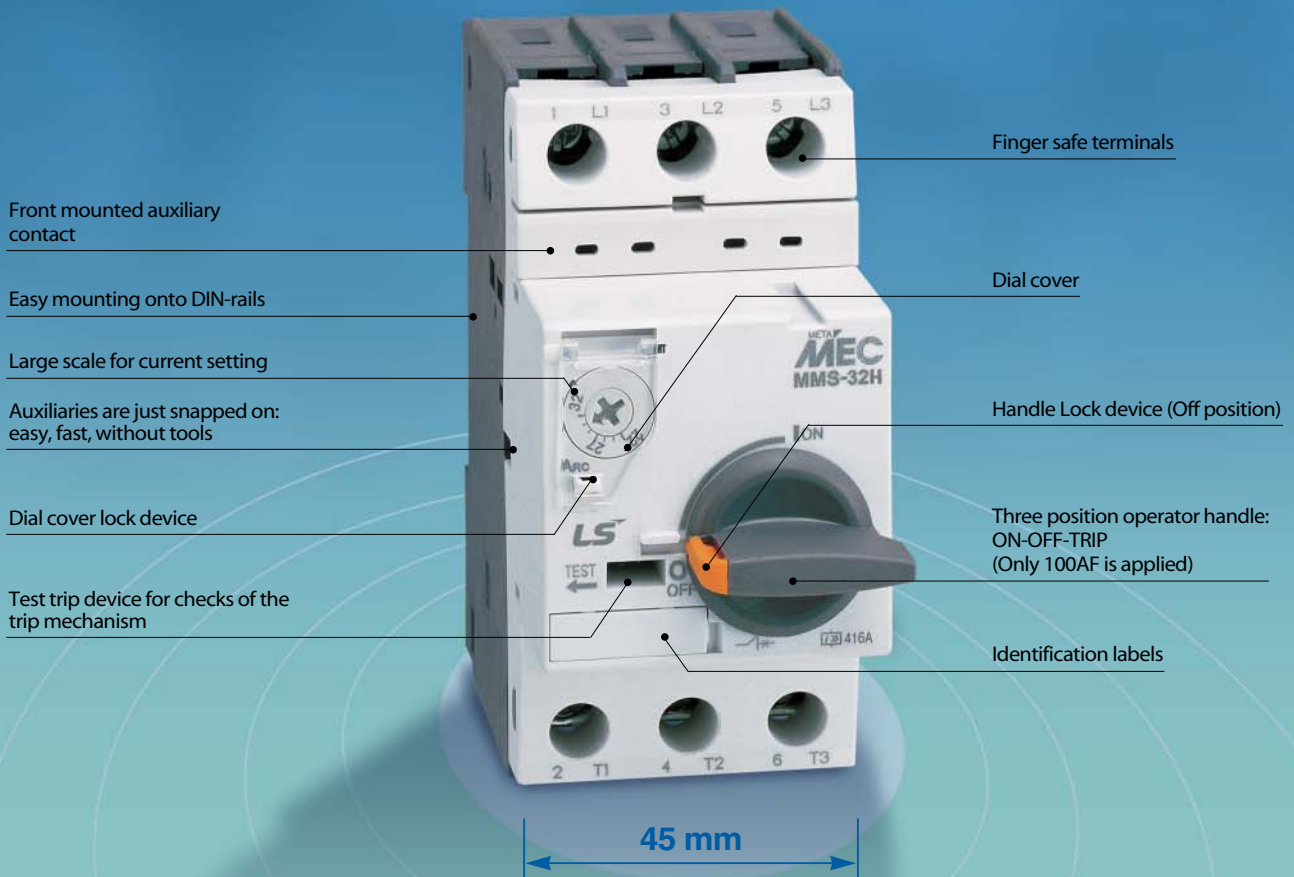

Handle Lock



Dial cover



Terminals

MMS-32



MMS-63



MMS-100



Function

- Protection of group installation
- Protection of circuits
- Motor protection
- Starter protection
- Wide range of ambient temperature compensation
- Phase failure protection



Feature

- 45mm width up to 32A, 55mm width up to 63A and 70mm width rated to 100 amps
- Three position operator: ON-OFF-TRIP (Only 100AF is applied)
- Complete range of common accessories
- Handle lock in the OFF position
- Class 10 overload trip characteristics
- Trip test
- Finger safe terminal
- DIN rail & Screw mounting

Standard

- Comply with the specifications in accordance with IEC 60947-2 & IEC 60947-4-1
- UL508 (Manual motor controller)
- UL508 (Combination motor controller type E starter)
- CSA C22.2 NO.14
- GB14048

Certification

- KEMA CB type certificate
- EC-Declaration of conformity
- UL listed • CSA certified • CCC



IEC 60947, UL 508

UL 508 Type E, K 60947, GB 14048

Contactors

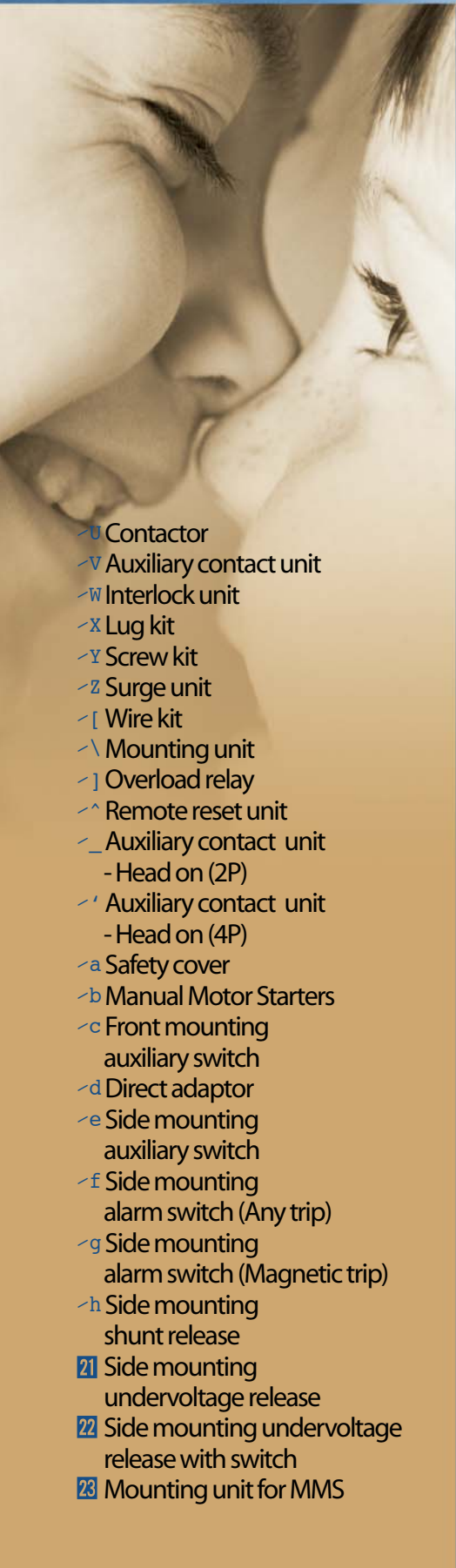

- U Contactor
- V Auxiliary contact unit
- W Interlock unit
- X Lug kit
- Y Screw kit
- Z Surge unit
- [Wire kit
- \ Mounting unit
-] Overload relay
- ^ Remote reset unit
- _ Auxiliary contact unit
 - Head on (2P)
- ' Auxiliary contact unit
 - Head on (4P)
- a Safety cover
- b Manual Motor Starters
- c Front mounting auxiliary switch
- d Direct adaptor
- e Side mounting auxiliary switch
- f Side mounting alarm switch (Any trip)
- g Side mounting alarm switch (Magnetic trip)
- h Side mounting shunt release
- 21 Side mounting undervoltage release
- 22 Side mounting undervoltage release with switch
- 23 Mounting unit for MMS

■ Combination with Accessories, Overload and MMS

- DIN rail mounting
- Easy to install
- Space saving
- Finger-proof design
- Safe and simple to work with
- Improved environmental performance

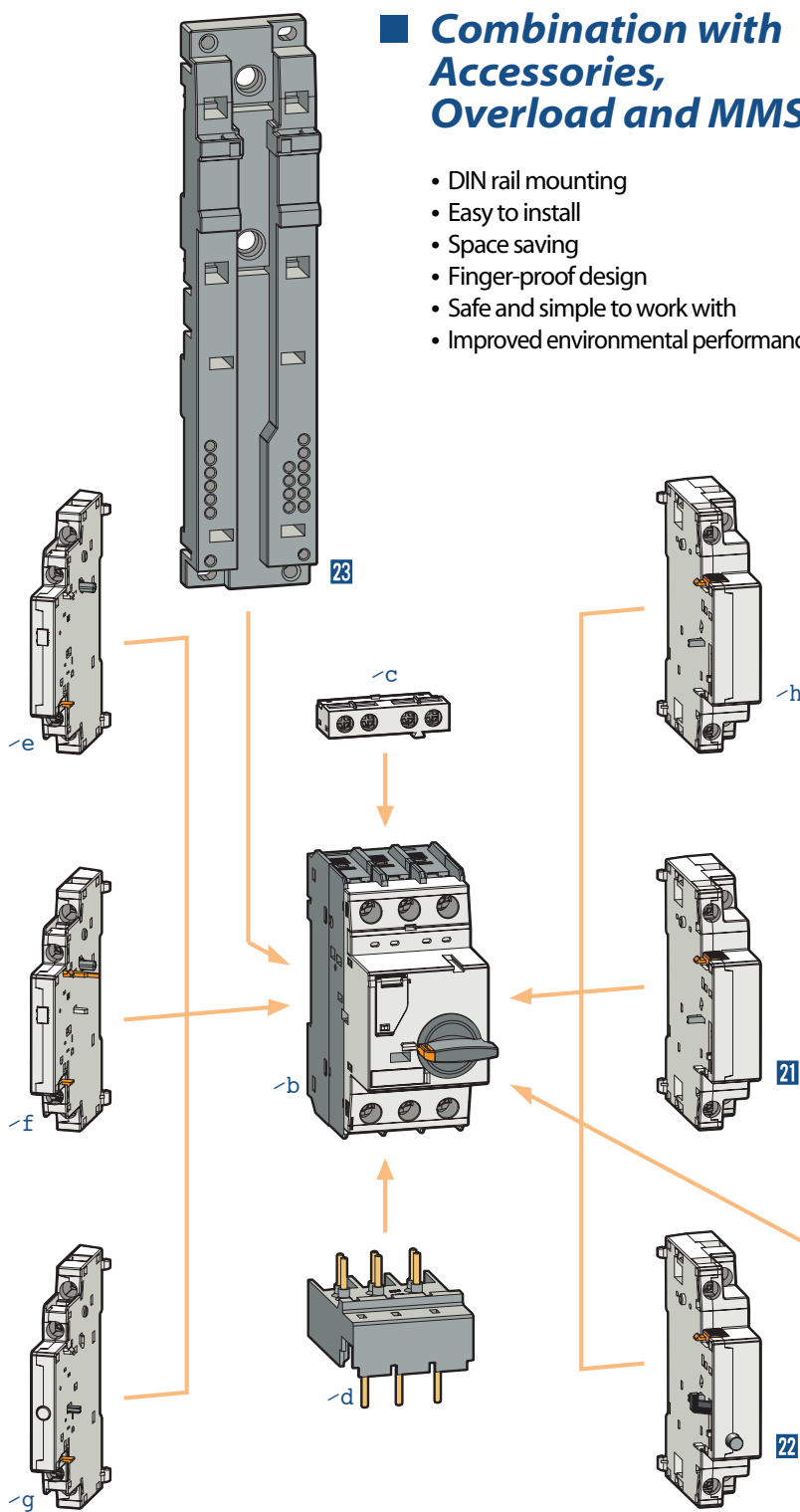



B-1. Contactors

Specifications	B-1-1
3-pole contactors	B-1-3
Reversing contactors	B-1-7
Control circuit characteristics	B-1-9
Auxiliary contacts/contact blocks characteristics	B-1-10
Accessories	
Auxiliary contact blocks	B-1-11
Mechanical interlocks	B-1-12
Capacitor units	B-1-13
Surge suppressor units	B-1-14
Direct adapters	B-1-15
Environment	B-1-16

Contactors

Susol

Specifications



Type		Model	
		Connection by screws clamp terminals	
		Connection by lugs	
Number of poles			
Rated operational voltage, Ue			
Rated insulation voltage, Ui			
		Conforming to IEC947-4-1	
		Conforming to UL, CSA	
Rated impulse withstand voltage, Uimp			
Degree of pollution (IEC60529)			
Rated operational current Ie ($\theta \leq 55^\circ\text{C}$)			
	AC-1	Ue max 690V	[A]
	AC-3	200/240V	[A]
		380/400V	[A]
		415V	[A]
		440V	[A]
		500V	[A]
		690V	[A]
Rated operational power ($\theta \leq 55^\circ\text{C}$)			
	AC-3	200/240V	[kW]
		380/400V	[kW]
		415V	[kW]
		440V	[kW]
		500V	[kW]
		690V	[kW]
According to IEC947-4-1			
		Rated making capacity AC-3	
		Rated breaking capacity AC-3	
Mechanical durability in millions of operating cycles			
Maximum operating rate In operating cycles per hour			
Mechanical durability in millions of operating cycles			
Maximum operating rate In operating cycles per hour			
Electrical life for Ie/AC-3 Max in millions of operating cycles			
Maximum operating rate in operating cycles per hour			
AC control coil voltage operated contactors			
		Weight [kg]	
		Basic dimensions (W × H × D) [mm]	
DC control coil voltage operated contactors			
		Weight [kg]	
		Basic dimensions (W × H × D) [mm]	

32AF				
MC-9	MC-12	MC-18	MC-25	MC-32
●	●	●	●	●
-	-	-	-	-
3				
690V				
1000V				
600V				
8kV				
IP20				
25	25	40	40	50
11	13	18	25	32
9	12	18	25	32
9	12	18	25	32
9	12	18	25	32
7	12	13	22	28
5	9	9	18	20
2.5	3.5	4.5	5.5	7.5
4	5.5	7.5	11	15
4	5.5	7.5	11	15
4	5.5	7.5	11	15
4	7.5	7.5	15	18.5
4	7.5	7.5	15	18.5
250				
200				
15	15	15	15	15
1800	1800	1800	1800	1800
8.07	8.07	8.07	8.07	8.07
7200	7200	7200	7200	7200
2.5	2.5	2.5	2.5	2.5
1800	1800	1800	1800	1800
0.45				
45 × 83 × 93				
0.63				
45 × 83 × 118				

Contactors

Susol



63AF

MC-35	MC-40	MC-50	MC-63
•	•	•	•
•	•	•	•

3

690V

1000V

600V

8kV

IP20

55	60	70	75
35	40	55	63
35	40	50	63
35	40	50	63
35	40	50	63
30	32	43	45
21	23	28	30

11	11	15	15
18.5	18.5	22	25
18.5	18.5	22	25
18.5	18.5	22	25
22	22	30	30
22	22	30	30

250

200

12	12	12	12
1200	1200	1200	1200
5.97	5.97	5.97	5.97
7200	7200	7200	7200
2	2	2	1.3
1200	1200	1200	1200

0.94

55 × 106 × 122

1.2

55 × 106 × 160.5



95AF

MC-65	MC-75	MC-85	MC-95
•	•	•	•
•	•	•	•

3

690V

1000V

600V

8kV

IP20

100	110	135	140
65	75	85	95
65	75	85	95
65	75	85	95
65	75	85	95
65	75	85	95
60	64	75	85
35	42	45	50

18.5	22	25	25
30	37	45	45
30	37	45	45
30	37	45	45
30	37	45	45
33	37	45	50
33	37	45	45

250

200

12	12	12	12
1200	1200	1200	1200
5.97	5.97	5.97	5.97
7200	7200	7200	7200
2	2	2	2
1200	1200	1200	1200

1.82

70 × 140 × 137

2.7

70 × 140 × 172.5

Contactors

Susol

3-pole contactors

for motor control up to 45kW at 440V in category AC-3

Control circuit voltage : AC or DC

Connection by screw clamp terminals



MC-32□



MC-63□S



MC-95□S

AC-3 operational power ratings 3-phase motors ($\theta \leq 55^\circ\text{C}$)						Rated operational current at AC-3	Built-in auxiliary contacts		Type	Weight
200 240V kW	380 400V kW	415V kW	440V kW	500V kW	690V kW		440V A	NO	NC	Connection by screw clamp terminals
2.5	4	4	4	4	4	9	-	-	MC-9	0.45
3.5	5.5	5.5	5.5	7.5	7.5	12	-	-	MC-12	0.45
4.5	7.5	7.5	7.5	7.5	7.5	18	-	-	MC-18	0.45
5.5	11	11	11	15	15	25	-	-	MC-25	0.45
11	18.5	18.5	18.5	22	22	32	-	-	MC-32	0.45
7.5	15	15	15	18.5	18.5	35	-	-	MC-35□S	0.94
11	18.5	18.5	18.5	22	22	40	-	-	MC-40□S	0.94
15	22	22	22	30	30	50	-	-	MC-50□S	0.94
15	25	25	25	30	30	63	-	-	MC-63□S	0.94
18.5	30	30	30	33	33	65	-	-	MC-65□S	1.82
22	37	37	37	37	37	75	-	-	MC-75□S	1.82
25	45	45	45	45	45	85	-	-	MC-85□S	1.82
25	45	45	45	50	45	95	-	-	MC-95□S	1.82

Accessories

Auxiliary contact blocks and modules: see pages B-1-13 to B-1-17.

Mounting

Clip-on mounting on 35 mm \square rail or screw fixing.
MC-65 to MC-95 types are mountable on 70mm DIN rail.

Standard control circuit voltage, Coil voltage

- AC circuit 50/60Hz
50Hz : 24, 32, 36, 42, 48, 80, 100, 110, 220, 230, 240, 380, 400, 415, 440, 500, 550V
60Hz : 24, 48, 100, 110, 120, 200, 208, 220, 230, 240, 277, 380, 440, 480, 600V
50/60Hz : 24, 48, 100, 110, 120, 200, 220, 230, 240, 380, 415, 440, 500, 550V
- DC circuit
12, 20, 24, 48, 60, 80, 100, 110, 125, 200, 220, 250V

Overloads to suit contactors are on page B-2-2.

Contactors

Susol

3-pole contactors

for motor control up to 45kW at 440V in category AC-3

Control circuit voltage : AC or DC

Connection by lugs



MC-63□L



MC-95□L

AC-3 operational power ratings 3-phase motors ($\theta \leq 55^\circ\text{C}$)						Rated operational current at AC-3	Built-in auxiliary contacts		Type	Weight
200 240V	380 400V	415V	440V	500V	690V		440V	NO	NC	Connection by lugs terminals
kW	kW	kW	kW	kW	kW	A				
7.5	15	15	15	18.5	18.5	35	-	-	MC-35□L	0.94
11	18.5	18.5	18.5	22	22	40	-	-	MC-40□L	0.94
15	22	22	22	30	30	50	-	-	MC-50□L	0.94
15	25	25	25	30	30	63	-	-	MC-63□L	0.94
18.5	30	30	30	33	33	65	-	-	MC-65□L	1.82
22	37	37	37	37	37	75	-	-	MC-75□L	1.82
25	45	45	45	45	45	85	-	-	MC-85□L	1.82
25	45	45	45	50	45	95	-	-	MC-95□L	1.82

Accessories

Auxiliary contact blocks and modules: see pages B-1-13 to B-1-17.

Mounting

Clip-on mounting on 35 mm \square rail or screw fixing.
MC-65 to MC-95 types are mountable on 70mm DIN rail.

Standard control circuit voltage, Coil voltage

- AC circuit 50/60Hz
50Hz : 24, 32, 36, 42, 48, 80, 100, 110, 220, 230, 240, 380, 400, 415, 440, 500, 550V
60Hz : 24, 48, 100, 110, 120, 200, 208, 220, 230, 240, 277, 380, 440, 480, 600V
50/60Hz : 24, 48, 100, 110, 120, 200, 220, 230, 240, 380, 415, 440, 500, 550V
- DC circuit
12, 20, 24, 48, 60, 80, 100, 110, 125, 200, 220, 250V

Overloads to suit contactors are on page B-2-2.

Contactors

Susol

3-pole contactors

for control in utilization category AC-1, 25 to 140 A

Control circuit voltage : AC or DC

Connection by screw clamp terminals



MC-32□



MC-63□S



MC-95□S

AC-1 Non inductive loads maximum current ($\theta \leq 55^\circ\text{C}$)	Number of poles	Built-in auxiliary contacts		Type	Weight
		NO	NC	NO	Connection by screw clamp terminals
AC-1 (A)					
25	3	-	-	MC-9	0.45
25	3	-	-	MC-12	0.45
40	3	-	-	MC-18	0.45
40	3	-	-	MC-25	0.45
50	3	-	-	MC-32	0.45
55	3	-	-	MC-35□S	0.94
60	3	-	-	MC-40□S	0.94
70	3	-	-	MC-50□S	0.94
75	3	-	-	MC-63□S	0.94
100	3	-	-	MC-65□S	1.82
110	3	-	-	MC-75□S	1.82
135	3	-	-	MC-85□S	1.82
140	3	-	-	MC-95□S	1.82

Accessories

Auxiliary contact blocks and modules: see pages B-1-13 to B-1-17.

Mounting

Clip-on mounting on 35 mm \square rail or screw fixing.
MC-65 to MC-95 types are mountable on 70mm DIN rail.

Standard control circuit voltage, Coil voltage

- AC circuit 50/60Hz
50Hz : 24, 32, 36, 42, 48, 80, 100, 110, 220, 230, 240, 380, 400, 415, 440, 500, 550V
60Hz : 24, 48, 100, 110, 120, 200, 208, 220, 230, 240, 277, 380, 440, 480, 600V
50/60Hz : 24, 48, 100, 110, 120, 200, 220, 230, 240, 380, 415, 440, 500, 550V
- DC circuit
12, 20, 24, 48, 60, 80, 100, 110, 125, 200, 220, 250V

Overloads to suit contactors are on page B-2-2.

Contactors

Susol

3-pole contactors

for control in utilization category AC-1, 25 to 140 A

Control circuit voltage : AC or DC

Connection by lugs



MC-63□L

AC-1 Non inductive loads maximum current ($\theta \leq 55^\circ\text{C}$)	Number of poles	Built-in auxiliary contacts		Type	Weight
		NC	NO	Connection by lugs terminals	AC control kg
AC-1 (A)	NO				
55	3	-	-	MC-35□L	0.94
60	3	-	-	MC-40□L	0.94
70	3	-	-	MC-50□L	0.94
75	3	-	-	MC-63□L	0.94
100	3	-	-	MC-65□L	1.82
110	3	-	-	MC-75□L	1.82
135	3	-	-	MC-85□L	1.82
140	3	-	-	MC-95□L	1.82



MC-95□L

Accessories

Auxiliary contact blocks and modules: see pages B-1-13 to B-1-17.

Mounting

Clip-on mounting on 35 mm \square rail or screw fixing.
MC-65 to MC-95 types are mountable on 70mm DIN rail.

Standard control circuit voltage, Coil voltage

- AC circuit 50/60Hz
50Hz : 24, 32, 36, 42, 48, 80, 100, 110, 220, 230, 240, 380, 400, 415, 440, 500, 550V
60Hz : 24, 48, 100, 110, 120, 200, 208, 220, 230, 240, 277, 380, 440, 480, 600V
50/60Hz : 24, 48, 100, 110, 120, 200, 220, 230, 240, 380, 415, 440, 500, 550V
- DC circuit
12, 20, 24, 48, 60, 80, 100, 110, 125, 200, 220, 250V

Overloads to suit contactors are on page B-2-2.

Contactors

Susol

Reversing contactors

for motor control up to 45kW at 440V in category AC-3

Control circuit voltage : AC or DC

Connection by screw clamp terminals



MC-32/R□



MC-63/R□



MC-95/R□

AC-3 operational power ratings 3-phase motors ($\theta \leq 55^\circ\text{C}$)						Rated operational current at AC-3	Built-in auxiliary per contactor		Type	Weight
200 240V	380 400V	415V	440V	500V	690V		440V	NO		
kW	kW	kW	kW	kW	kW	A				kg
2.5	4	4	4	4	4	9	-	-	MC-9/R□	0.95
3.5	5.5	5.5	5.5	7.5	7.5	12	-	-	MC-12/R□	0.95
4.5	7.5	7.5	7.5	7.5	7.5	18	-	-	MC-18/R□	0.95
5.5	11	11	11	15	15	25	-	-	MC-25/R□	0.95
11	18.5	18.5	18.5	22	22	32	-	-	MC-32/R□	0.95
7.5	15	15	15	18.5	18.5	35	-	-	MC-35/R□	1.73
11	18.5	18.5	18.5	22	22	40	-	-	MC-40/R□	1.73
15	22	22	22	30	30	50	-	-	MC-50/R□	1.73
15	25	25	25	30	30	63	-	-	MC-63/R□	1.73
18.5	30	30	30	33	33	65	-	-	MC-65/R□	3.25
22	37	37	37	37	37	75	-	-	MC-75/R□	3.25
25	45	45	45	45	45	85	-	-	MC-85/R□	3.25
25	45	45	45	50	45	95	-	-	MC-95/R□	3.25

Note :

- Pre-wired power connections.
- Mechanical interlock without electrical interlocking.
- Please contact LSIS for reversing contactors with electrical interlocking pre-wired at the factory.

Accessories

Auxiliary contact blocks and modules: see pages B-1-13 to B-1-17.

MC-65 to MC-95 types are mountable on 70mm DIN rail.

Mounting

Clip-on mounting on 35 mm  rail or screw fixing.

Standard control circuit voltage, Coil voltage

- AC circuit 50/60Hz
50Hz : 24, 32, 36, 42, 48, 80, 100, 110, 220, 230, 240, 380, 400, 415, 440, 500, 550V
60Hz : 24, 48, 100, 110, 120, 200, 208, 220, 230, 240, 277, 380, 440, 480, 600V
50/60Hz : 24, 48, 100, 110, 120, 200, 220, 230, 240, 380, 415, 440, 500, 550V
- DC circuit
12, 20, 24, 48, 60, 80, 100, 110, 125, 200, 220, 250V

Contactors

Susol

Reversing contactors

for motor control up to 45kW at 440V in category AC-3

Control circuit voltage : AC or DC

Connection by lugs



MC-63/R□L



MC-95/R□L

AC-3 operational power ratings 3-phase motors ($\theta \leq 55^\circ\text{C}$)						Rated operational current at AC-3	Built-in auxiliary contacts per contactor		Type	Weight
200 240V	380 400V	415V	440V	500V	690V		440V	NO		
kW	kW	kW	kW	kW	kW	A				kg
7.5	15	15	15	18.5	18.5	35	-	-	MC-35/R□L	1.73
11	18.5	18.5	18.5	22	22	40	-	-	MC-40/R□L	1.73
15	22	22	22	30	30	50	-	-	MC-50/R□L	1.73
15	25	25	25	30	30	63	-	-	MC-63/R□L	1.73
18.5	30	30	30	33	33	65	-	-	MC-65/R□L	3.25
22	37	37	37	37	37	75	-	-	MC-75/R□L	3.25
25	45	45	45	45	45	85	-	-	MC-85/R□L	3.25
25	45	45	45	45	45	95	-	-	MC-95/R□L	3.25

Note :

- Pre-wired power connections.
- Mechanical interlock without electrical interlocking.
- Please contact LSIS for reversing contactors with electrical interlocking pre-wired at the factory.

Accessories

Auxiliary contact blocks and modules: see pages B-1-13 to B-1-17.

Mounting

Clip-on mounting on 35 mm  rail or screw fixing.
MC-65 to MC-95 types are mountable on 70mm DIN rail.

Standard control circuit voltage, Coil voltage

- AC circuit 50/60Hz
50Hz : 24, 32, 36, 42, 48, 80, 100, 110, 220, 230, 240, 380, 400, 415, 440, 500, 550V
60Hz : 24, 48, 100, 110, 120, 200, 208, 220, 230, 240, 277, 380, 440, 480, 600V
50/60Hz : 24, 48, 100, 110, 120, 200, 220, 230, 240, 380, 415, 440, 500, 550V
- DC circuit
12, 20, 24, 48, 60, 80, 100, 110, 125, 200, 220, 250V

Contactors

Susol

Control circuit characteristics



Type	32AF	63AF	95AF
Contactor types	MC-9 MC-12 MC-18 MC-25 MC-32	MC-35 MC-40 MC-50 MC-63	MC-65 MC-75 MC-85 MC-95
AC control circuit characteristics			
Rated control circuit voltage [Uc]	24, 32, 36, 42, 48, 80, 100, 110, 220, 230, 240, 380, 400, 415, 440, 500, 550V		
50Hz [V]	24, 48, 100, 110, 120, 200, 208, 220, 230, 240, 277, 380, 440, 480, 600V		
60Hz [V]	24, 48, 100, 110, 120, 200, 220, 230, 240, 380, 415, 440, 500, 550V		
50/60Hz [V]	24, 48, 100, 110, 120, 200, 220, 230, 240, 380, 415, 440, 500, 550V		
Control voltage limits	0.8 ... 1.1 Uc on 50 Hz		
Operational	0.85 ... 1.1 Uc on 60 Hz		
Drop-out	0.3 ... 0.6 Uc		
Coil consumption at 20°C			
Inrush [VA]	80	120	220
Holding [VA]	9	11	16
Heat dissipation [W]	2.2	2.2	5.1
Operating time			
Closing [ms]	12 ... 22	12 ... 22	15 ... 30
Opening [ms]	4 ... 19	4 ... 19	15 ... 30
DC control circuit characteristics			
Rated control circuit voltage [Uc]	12, 20, 24, 48, 60, 80, 100, 110, 125, 200, 220, 250		
Control voltage limits	0.7 ... 1.25Uc		
Operational	0.1 ... 0.3 Uc		
Drop-out			
Coil consumption at 20°C			
Inrush [W]	7	9	18
Holding [W]	7	9	18
Time constant (L/R) [ms]	28	65	75
Operating time			
Closing [ms]	12 ... 22	12 ... 22	100 ... 120
Opening [ms]	4 ... 19	4 ... 19	10 ... 25

Contactors

Susol

Auxiliary contacts/contact blocks characteristics

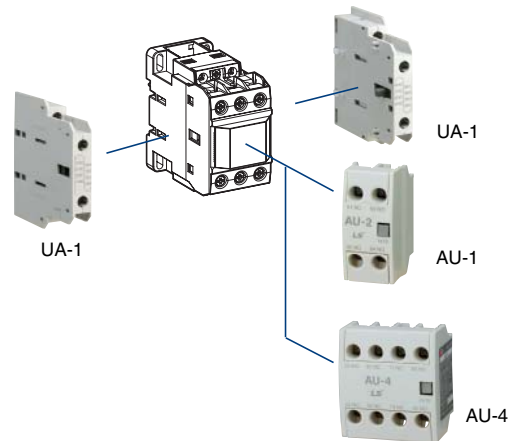

Contactor frame	
Contactor types	
Number of auxiliary contact	
Normally open	[EA]
Normally closed	[EA]
Auxiliary contact blocks, optional	
Type	
Number of auxiliary contact	
Normally open	[EA]
Normally closed	[EA]
Characteristics	
Rated operational voltage, Ue [V]	
Rated insulation voltage, Ui	
Conforming to IEC 947-1 [V]	
Conforming to UL, CSA [V]	
Operating current frequency [Hz]	
Short-circuit protection	
Minimum switching capacity	
U min.	DC [V]
I min.	[mA]
Thermal current, Ith [A]	
Operational current	
AC15 duty (A600)	120V [A]
	240V [A]
	480V [A]
	600V [A]
DC13 duty (P600)	125V [A]
	250V [A]
	440V [A]
	600V [A]
Lifetime (mil.operations)	
AC15 duty	220V
	440V
DC13 duty	220V
	440V
Operation cycles per hour	

32AF			63AF					95AF	
MC-9			MC-35					MC-65	
MC-12			MC-40					MC-75	
MC-18			MC-50					MC-85	
MC-25			MC-63					MC-95	
MC-32									
-			-					-	
-			-					-	
AU-2			AU-4					UA-1	
2	1	0	4	3	2	1	0	1	
0	1	2	0	1	2	3	4	1	
Rated operational voltage, Ue [V]									
600									
Rated insulation voltage, Ui									
600									
Conforming to IEC 947-1 [V]									
600									
Conforming to UL, CSA [V]									
25~400									
Operating current frequency [Hz]									
gLgG fuse: 16A (conforming to IEC EN947-5-1)									
Short-circuit protection									
Minimum switching capacity									
U min. DC [V]									
17									
I min. [mA]									
5									
Thermal current, Ith [A]									
16									
Operational current									
AC15 duty (A600)									
120V [A]									
6									
240V [A]									
3									
480V [A]									
1.5									
600V [A]									
1.2									
DC13 duty (P600)									
125V [A]									
1.1									
250V [A]									
0.55									
440V [A]									
0.31									
600V [A]									
0.2									
Lifetime (mil.operations)									
AC15 duty									
220V									
0.5									
440V									
0.5									
DC13 duty									
220V									
0.5									
440V									
0.5									
Operation cycles per hour									
1800									

Accessories

Auxiliary contact blocks

for contactors and reversing contactors

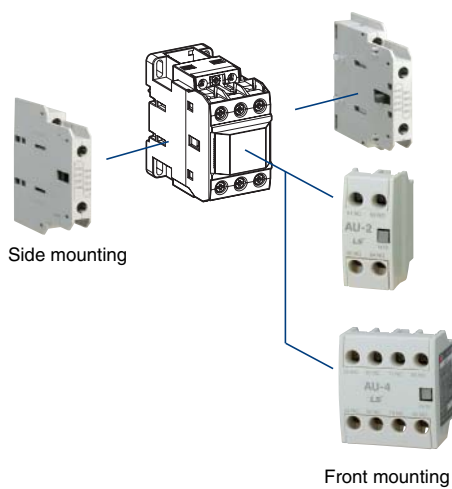

Using contactors	Mounting	Number of contacts per block	Composition		Type	Weight
			NO	NC		g
Contactors and reversing contactors MC-9 to 95 MC-9R to 95R	Front	2	1	1	AU-2	28
			2	-		
		4	-	2		
			2	2	AU-4	50
	1	3				
4	-	4				
Side	2	2	3	1	UA-1	53
			1	1		



Contactors

Susol

Accessories

Mechanical/Electrical interlocks

for reversing contactors

for motor control

To be assembled by customer

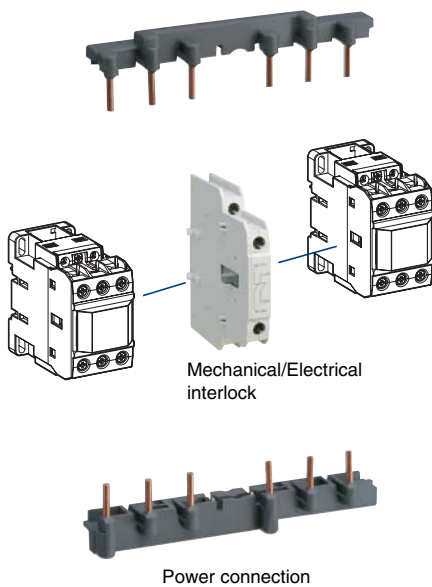

Using contactors with screw clamp terminals	Set of power connections		Mechanical/Electrical interlock	
	Type	Weight g	Type	Weight g
MC-9 MC-12 MC-18 MC-25 MC-32	UW-32	45	UR-02	64
MC-35 MC-40 MC-50 MC-63	UW-63	12.5		
MC-65 MC-75 MC-85 MC-95	UW-95	325		

Note :

- Component parts for assembling by customer
- Mechanical interlock with 2NC contacts for electrical interlocking
- UR-02 provides both mechanical and electrical interlocks



Contactors

Susol

Accessories

Capacitor units

Description

- MC-□(D), a contactor or special use, is adjusted for switching single-step or multiple-step condenser bank.
- It is standardized by IEC-60947-4941, UL and CSA.

Operation condition

Operating times	MC-9(D)~32(D)	240 times/h
	MC-35(D)~95(D)	100 times/h
Electrical endurance	MC-9(D)~32(D)	200,000 times/h
	MC-35(D)~95(D)	100,000 times/h

- When the switch is closed condenser must be discharged before recharged. (Maximum residual voltage at terminals $\leq 50V$)
- In working voltage 500V($U_e=500V$), 100,000 times for MC-9(D)~32(D) and 80,000 times for MC-35(D)~95(D).
- To prevent short current, gG type fuse must be 1.5~2 times than rated current.
- It must be separated from resistant wire

Rating

Type	Maximum operating power at (kvar)			Rated current (A)	Applied unit
	220~240V	400~440V	600~550V		
MC-9(D)	5	9.7	14	14	AC-9
MC-12(D)	6.7	12.5	18	18	AC-9
MC-18(D)	8.5	16.7	24	24	AC-9
MC-25(D)	10	18	26	26	AC-9
MC-32(D)	15	25	36	36	AC-9
MC-35(D)	18	30	42	42	AC-50
MC-40(D)	20	33.3	48	48	AC-50
MC-50(D)	20	40	58	58	AC-50
MC-63(D)	23	42	60	60	AC-50
MC-65(D)	25	45.7	66	66	AC-50
MC-75(D)	29.7	54	78	78	AC-50
MC-85(D)	35	60	92	92	AC-50
MC-95(D)	37	62	94	94	AC-50

Note) 1. Circumstance Temp. $\theta \leq 55^\circ C$

2. The average temperature over a 24-hour period, in accordance with standards IEC 70 and 831 is 45°C



Mounting unit

Phase-bus devices, Type MU, followed by MMS-32, 63 and 100

These devices are attached module to connect joined Manual Motor Starter with Contactor.

Type	Model	Description	Applied type
Mounting unit	MU-45	Width 45mm	MMS-32S/H/HI+MC-9~32 or GMC(D)-M
	MU-55	Width 55mm	MMS-63S/H/HI+MC-35~63
	MU-70	Width 70mm	MMS-100S/H/HI+MC-65~95

Accessories

Susol

Accessories

Surge suppressor units

for contactors and reversing contactors

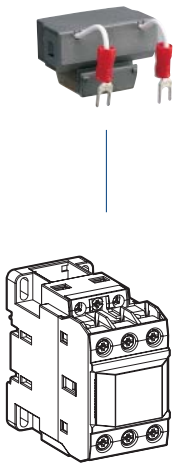

Using contactors	Rating	V	Type	Internal element	Weight
					g
Contactors and reversing contactors MC-9 to 95	AC	24~48V	US-1	Varistor+RC	20
		100~125V	US-2	Varistor+RC	
		200~240V	US-3	RC	
		380~440V	US-14	Varistor+RC	
	DC	24~48V	US-4	Varistor	
		100~125V	US-5	Varistor+RC	
		200~220V	US-6	Varistor+RC	
	AC/DC common	24~48V	US-11	Varistor	
		100~125V	US-12	Varistor	
		200~240V	US-13	Varistor	

- Rated insulation voltage (Ui) : AC 1000V
- Rated impulse voltage (Uimp) : 8kV
- Degree of protection (IEC 60 529) : IP20

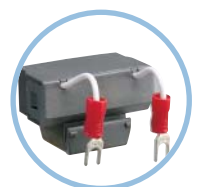

Accessories

Direct adapters

for connection element to combine
a Manual Motor Starter(MMS) with a Contactor.



Using contactors	Using manual motor starters		Type	Weight g
	Type	Setting range		
MC-9 with AC coil MC-12 with AC coil MC-18 with AC coil MC-25 with AC coil MC-32 with AC coil	MMS-32S	0.1~32A	DA-32SA	27
	MMS-32H	0.1~32A	DA-32HA	
MC-9 with DC coil MC-12 with DC coil MC-18 with DC coil MC-25 with DC coil MC-32 with DC coil	MMS-32S	0.1~32A	DA-32SD	36
	MMS-32H	0.1~32A	DA-32HD	
MC-35 with AC coil MC-40 with AC coil MC-50 with AC coil MC-63 with AC coil	MMS-63	6~63A	DA-63A	56
MC-35 with DC coil MC-40 with DC coil MC-50 with DC coil MC-63 with DC coil	MMS-63	6~63A	DA-63D	69
MC-65 with AC coil MC-75 with AC coil MC-85 with AC coil MC-95 with AC coil	MMS-100	11~100A	DA-95A	94
MC-65 with DC coil MC-75 with DC coil MC-85 with DC coil MC-95 with DC coil	MMS-100	11~100A	DA-95D	118



Contactors

Susol

Environment



Environment		
Standards	EN 60947-1, EN 60947-4-1	
Product certifications	CE, CSA, UL	
Degree of protection (IEC 60 529)	Power terminals	IP20
	Coil terminals	IP20
Ambient air temperature	Storage	- 60...+ 80°C
	Normal operation	- 25...+ 55°C
Operating altitude	Maximum 3000m	
Operating positions(without derating)	± 30° possible, in relation to normal vertical mounting plane	
Shock resistance (IEC 68-2-7) (1/2 sine wave = 11ms)	Contactor open	8 gn
	Contactor closed	10 gn
Vibration resistance (IEC 68-2-6) (5...300 Hz)	Contactor open	2 gn
	Contactor closed	4 gn
Flame resistance	Conforming to UL 94	V0
	Conforming to IEC 695-2-1	960°C



B-2. Overload relays

Specifications	B-2-1
Characteristics class 10A	B-2-3
Characteristics class 20	B-2-5
Accessories	B-2-7
Tripping characteristics	B-2-9

Overload relays

Susol

Specifications

Type MT, bimetal-style, overload relays are designed to protect AC circuits and motors against overloads, phase failure, long starting times and prolonged stalling of the motor.

Configuration

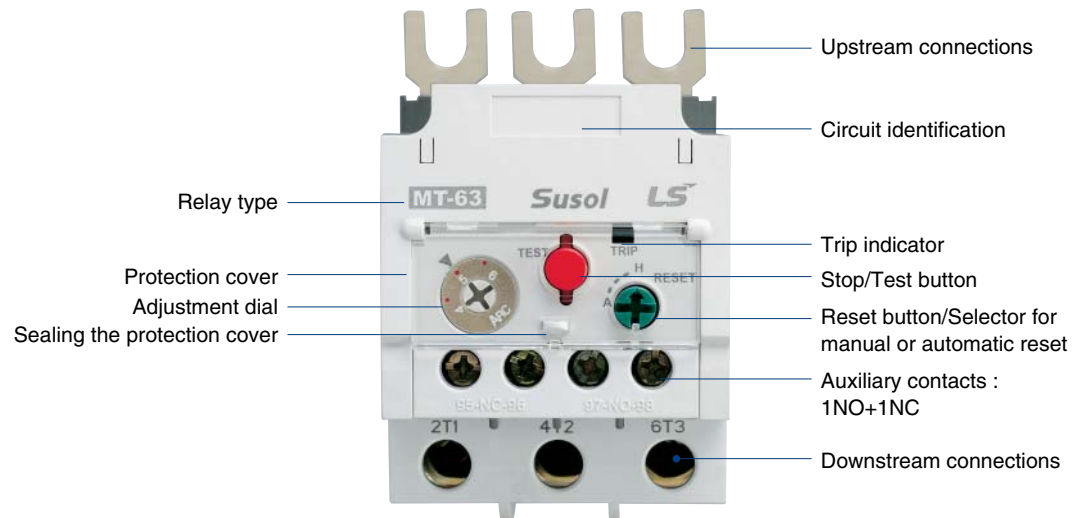

Note :

- Relays are supplied with the selector in the manual position.
- Test button allows:
 - checking of control circuit wiring,
 - simulation of relay tripping (actuates both the NO and NC contacts).
- Push the button(stop function)
- Pull the button(test function)

	Stop	Test/ Trip	Reset
NC 95-96			
NO 97-98			

Environment		
Standards	EN 60947-1, EN 60947-4-1	
Product certifications	CE, CSA, UL	
Degree of protection (IEC 60 529)	IP 20	
Ambient air temperature	Storage	- 60...+ 70°C
	Normal operation	- 5...+ 55°C
Operating positions	In relation to normal, vertical mounting plane	
Shock resistance (IEC 68-2-7)	15gn - 11ms	
Vibration resistance (IEC 68-2-6)	6gn	
Dielectric strength at 50 Hz (IEC 255-5)	6kV	
Impulse withstand voltage (IEC 801-5)	6kV	
Auxiliary contact characteristics		
Rating	C600, R300	
Thermal current	5A	
Connection to screw clamp terminals	1 or 2 conductors	
	- Flexible cable with cable end	1~2.5mm ²
	- Flexible cable with end	1~2.5mm ²
	- Solid cable without cable end	1~2.5mm ²
	- Tightening torque	2.3N.m

Overload relays

Susol

Specifications

Electrical characteristics of power circuit

Relay type		32AF		63AF				95AF			
Type	Differential type (Phase failure protection)	MT-32/3K□	MT-32/3D□	MT-63/3K□S	MT-63/3D□S	MT-63/3K□L	MT-63/3D□L	MT-95/3K□S	MT-95/3D□S	MT-95/3K□L	MT-95/3D□L
	Non-differential type	MT-32/3H□	-	MT-63/3H□S	-	MT-63/3H□L	-	MT-95/3H□S	-	MT-95/3H□L	-
	3 heater type	MT-32/2H□	-	MT-63/2H□S	-	MT-63/2H□L	-	MT-95/2H□S	-	MT-95/2H□L	-
Tripping class(IEC 60947-4-1)		10A	20	10A	20	10A	20	10A	20	10A	20
Terminal type		Screw clamp		Screw clamp		Lug		Screw clamp		Lug	
Number of poles		3		3		3		3		3	
Rated operational voltage (Ue)		Up to 690V		Up to 690V		Up to 690V		Up to 690V		Up to 690V	
Rated insulation voltage (Ui)		690V		690V		690V		690V		690V	
Rated impulse voltage (Uimp)		6kV		6kV		6kV		6kV		6kV	
Setting range		0.1~32A	1~32A	4~65A		4~65A		7~95A		7~95A	
Degree of protection (IEC 60 529)		IP 20		IP 20		IP 20		IP 20		IP 20	
Temperature compensation (°C)		-5 ~ +40		-5 ~ +40		-5 ~ +40		-5 ~ +40		-5 ~ +40	
Functions											
Trip indicating		●		●		●		●		●	
Stop		●		●		●		●		●	
Test		●		●		●		●		●	
Manual/Automatic Reset		●		●		●		●		●	
Applied contactors		MC-9, 12, 18, 25, 32		MC-35, 40, 50, 63				MC-65, 75, 85, 95			

Note) □ is rated current.

Detail setting range and connection cable

Class	32AF		63AF	95AF	Current Setting range(A)	Wire Size		Wire Type	Max. number of conductors	Short circuit "r"
	10A	20	10A, 20	10A, 20		mm ²	AWG			
	●					0.1~0.16	1			
●				0.16~0.25						
●				0.25~0.4						
●				0.4~0.63						
●				0.63~1						
●	●			1~1.6						
●	●			1.6~2.5						
●	●			2.5~4						
●	●	●		4~6						
●	●	●		5~8						
●	●	●		6~9	1~1.5	18 ~16	65/75°C Cu-wire only	2	1kA	
●	●	●	●	7~10						
●	●	●	●	9~13						
●	●	●	●	12~18						
●	●	●	●	16~22						
●	●	●	●	18~25						
●	●	●	●	22~32						
		●	●	24~36						
		●	●	28~40						
		●	●	34~50						
		●	●	45~65	10~16	8~6	65/75°C Cu-wire only	2	3kA	
		●	●	54~75						
		●	●	63~85						
			●	70~95	16~25	6~4	65/75°C Cu-wire only	2	5kA	
			●	70~95	25~35	4~3				

Overload relays

Susol

Characteristics class 10A

for direct mounting beneath contactors
with connection by screw clamp terminals



MT-32/3K □



MT-63/3K □S



MT-95/3K □S

Corresponding contactors	Relay setting range	Relay types			Weight
		Differential	Non-differential		
Type	A	3Heaters	3Heaters	2Heaters	kg
MC-9	0.1~0.16	MT-32/3K 0.14	MT-32/3H 0.14	MT-32/2H 0.14	0.17
MC-12	0.16~0.25	MT-32/3K 0.21	MT-32/3H 0.21	MT-32/2H 0.21	
MC-18	0.25~0.4	MT-32/3K 0.33	MT-32/3H 0.33	MT-32/2H 0.33	
MC-25	0.4~0.63	MT-32/3K 0.52	MT-32/3H 0.52	MT-32/2H 0.52	
MC-32	0.63~1	MT-32/3K 0.82	MT-32/3H 0.82	MT-32/2H 0.82	
	1~1.6	MT-32/3K 1.3	MT-32/3H 1.3	MT-32/2H 1.3	
	1.6~2.5	MT-32/3K 2.1	MT-32/3H 2.1	MT-32/2H 2.1	
	2.5~4	MT-32/3K 3.3	MT-32/3H 3.3	MT-32/2H 3.3	
	4~6	MT-32/3K 5	MT-32/3H 5	MT-32/2H 5	
	5~8	MT-32/3K 6.5	MT-32/3H 6.5	MT-32/2H 6.5	
	6~9	MT-32/3K 7.5	MT-32/3H 7.5	MT-32/2H 7.5	
	7~10	MT-32/3K 8.5	MT-32/3H 8.5	MT-32/2H 8.5	
	9~13	MT-32/3K 11	MT-32/3H 11	MT-32/2H 11	
	12~18	MT-32/3K 15	MT-32/3H 15	MT-32/2H 15	
	16~22	MT-32/3K 19	MT-32/3H 19	MT-32/2H 19	
	18~25	MT-32/3K 21.5	MT-32/3H 21.5	MT-32/2H 21.5	
	22~32	MT-32/3K 27	MT-32/3H 27	MT-32/2H 27	
MC-35	4~6	MT-63/3K 5S	MT-63/3H 5S	MT-63/2H 5S	0.31
MC-40	5~8	MT-63/3K 6.5S	MT-63/3H 6.5S	MT-63/2H 6.5S	
MC-50	6~9	MT-63/3K 7.5S	MT-63/3H 7.5S	MT-63/2H 7.5S	
MC-63	7~10	MT-63/3K 8.5S	MT-63/3H 8.5S	MT-63/2H 8.5S	
	9~13	MT-63/3K 11S	MT-63/3H 11S	MT-63/2H 11S	
	12~18	MT-63/3K 15S	MT-63/3H 15S	MT-63/2H 15S	
	16~22	MT-63/3K 19S	MT-63/3H 19S	MT-63/2H 19S	
	18~25	MT-63/3K 21.5S	MT-63/3H 21.5S	MT-63/2H 21.5S	
	24~36	MT-63/3K 30S	MT-63/3H 30S	MT-63/2H 30S	
	28~40	MT-63/3K 34S	MT-63/3H 34S	MT-63/2H 34S	
MC-65	7~10	MT-95/3K 8.5S	MT-95/3H 8.5S	MT-95/2H 8.5S	0.48
MC-75	9~13	MT-95/3K 11S	MT-95/3H 11S	MT-95/2H 11S	
MC-85	12~18	MT-95/3K 15S	MT-95/3H 15S	MT-95/2H 15S	
MC-95	16~22	MT-95/3K 19S	MT-95/3H 19S	MT-95/2H 19S	
	18~25	MT-95/3K 21.5S	MT-95/3H 21.5S	MT-95/2H 21.5S	
	24~36	MT-95/3K 30S	MT-95/3H 30S	MT-95/2H 30S	
	28~40	MT-95/3K 34S	MT-95/3H 34S	MT-95/2H 34S	
	34~50	MT-95/3K 42S	MT-95/3H 42S	MT-95/2H 42S	
	45~65	MT-95/3K 55S	MT-95/3H 55S	MT-95/2H 55S	
	54~75	MT-95/3K 65S	MT-95/3H 65S	MT-95/2H 65S	
	63~85	MT-95/3K 74S	MT-95/3H 74S	MT-95/2H 74S	
	70~95	MT-95/3K 83S	MT-95/3H 83S	MT-95/2H 83S	

Accessories

Separate mounting adapters and remote reset unit : see pages B-2-7 to B-2-8

Mounting

Direct mounting on to a contactor with screw clamp terminals

Overload relays

Susol

Characteristics class 10A

for direct mounting beneath contactors
with connection by lug terminals



Corresponding contactors	Relay setting range	Relay types			Weight	
		Differential	Non-differential			
Type	A	3Heaters	3Heaters	2Heaters	kg	
MC-35	4~6	MT-63/3K 5L	MT-63/3H 5L	MT-63/2H 5L	0.33	
MC-40	5~8	MT-63/3K 6.5L	MT-63/3H 6.5L	MT-63/2H 6.5L		
MC-50	6~9	MT-63/3K 7.5L	MT-63/3H 7.5L	MT-63/2H 7.5L		
MC-63	7~10	MT-63/3K 8.5L	MT-63/3H 8.5L	MT-63/2H 8.5L		
	9~13	MT-63/3K 11L	MT-63/3H 11L	MT-63/2H 11L		
	12~18	MT-63/3K 15L	MT-63/3H 15L	MT-63/2H 15L		
	16~22	MT-63/3K 19L	MT-63/3H 19L	MT-63/2H 19L		
	18~25	MT-63/3K 21.5L	MT-63/3H 21.5L	MT-63/2H 21.5L		
	24~36	MT-63/3K 30L	MT-63/3H 30L	MT-63/2H 30L		
	28~40	MT-63/3K 34L	MT-63/3H 34L	MT-63/2H 34L		
	34~50	MT-63/3K 42L	MT-63/3H 42L	MT-63/2H 42L		
	45~65	MT-63/3K 55L	MT-63/3H 55L	MT-63/2H 55L		
MC-65	7~10	MT-95/3K 8.5L	MT-95/3H 8.5L	MT-95/2H 8.5L		0.50
MC-75	9~13	MT-95/3K 11L	MT-95/3H 11L	MT-95/2H 11L		
MC-85	12~18	MT-95/3K 15L	MT-95/3H 15L	MT-95/2H 15L		
MC-95	16~22	MT-95/3K 19L	MT-95/3H 19L	MT-95/2H 19L		
	18~25	MT-95/3K 21.5L	MT-95/3H 21.5L	MT-95/2H 21.5L		
	24~36	MT-95/3K 30L	MT-95/3H 30L	MT-95/2H 30L		
	28~40	MT-95/3K 34L	MT-95/3H 34L	MT-95/2H 34L		
	34~50	MT-95/3K 42L	MT-95/3H 42L	MT-95/2H 42L		
	45~65	MT-95/3K 55L	MT-95/3H 55L	MT-95/2H 55L		
	54~75	MT-95/3K 65L	MT-95/3H 65L	MT-95/2H 65L		
	63~85	MT-95/3K 74L	MT-95/3H 74L	MT-95/2H 74L		
	70~95	MT-95/3K 83L	MT-95/3H 83L	MT-95/2H 83L		

Accessories

Separate mounting adapters and remote reset unit : see pages B-2-7 to B-2-8

Mounting

Direct mounting on to a contactor with lug terminals

Overload relays

Susol

Characteristics class 20

for direct mounting beneath contactors
with connection by screw clamp terminals



MT-32/3D□



MT-63/3D□S



MT-95/3D□S

Corresponding contactors	Relay setting range	Relay types	Weight
		Differential	
Type	A	3Heaters	kg
MC-9	1~1.6	MT-32/3D 1.3	0.17
MC-12	1.6~2.5	MT-32/3D 2.1	
MC-18	2.5~4	MT-32/3D 3.3	
MC-25	4~6	MT-32/3D 5	
MC-32	5~8	MT-32/3D 6.5	
	6~9	MT-32/3D 7.5	
	7~10	MT-32/3D 8.5	
	9~13	MT-32/3D 11	
	12~18	MT-32/3D 15	
	16~22	MT-32/3D 19	
	18~25	MT-32/3D 21.5	
	22~32	MT-32/3D 27	
MC-35	4~6	MT-63/3D 5S	
MC-40	5~8	MT-63/3D 6.5S	
MC-50	6~9	MT-63/3D 7.5S	
MC-63	7~10	MT-63/3D 8.5S	
	9~13	MT-63/3D 11S	
	12~18	MT-63/3D 15S	
	16~22	MT-63/3D 19S	
	18~25	MT-63/3D 21.5S	
	24~36	MT-63/3D 30S	
	28~40	MT-63/3D 34S	
	34~50	MT-63/3D 42S	
	45~65	MT-63/3D 55S	
MC-65	7~10	MT-95/3D 8.5S	0.48
MC-75	9~13	MT-95/3D 11S	
MC-85	12~18	MT-95/3D 15S	
MC-95	16~22	MT-95/3D 19S	
	18~25	MT-95/3D 21.5S	
	24~36	MT-95/3D 30S	
	28~40	MT-95/3D 34S	
	34~50	MT-95/3D 42S	
	45~65	MT-95/3D 55S	
	54~75	MT-95/3D 65S	
	63~85	MT-95/3D 74S	
	70~95	MT-95/3D 83S	

Accessories

Separate mounting adapters and remote reset unit : see pages B-2-7 to B-2-8

Mounting

Direct mounting on to a contactor with screw clamp terminals

Overload relays

Susol

Characteristics class 20

for direct mounting beneath contactors
with connection by lug terminals



MT-63/3D □L



MT-95/3D □L

Corresponding contactors	Relay setting range	Relay types	Weight	
		Differential		
Type	A	3Heaters	kg	
MC-35	4~6	MT-63/3D 5L	0.33	
MC-40	5~8	MT-63/3D 6.5L		
MC-50	6~9	MT-63/3D 7.5L		
MC-63	7~10	MT-63/3D 8.5L		
	9~13	MT-63/3D 11L		
	12~18	MT-63/3D 15L		
	16~22	MT-63/3D 19L		
	18~25	MT-63/3D 21.5L		
	24~36	MT-63/3D 30L		
	28~40	MT-63/3D 34L		
	34~50	MT-63/3D 42L		
	45~65	MT-63/3D 55L		
MC-65	7~10	MT-95/3D 8.5L		0.50
MC-75	9~13	MT-95/3D 11L		
MC-85	12~18	MT-95/3D 15L		
MC-95	16~22	MT-95/3D 19L		
	18~25	MT-95/3D 21.5L		
	24~36	MT-95/3D 30L		
	28~40	MT-95/3D 34L		
	34~50	MT-95/3D 42L		
	45~65	MT-95/3D 55L		
	54~75	MT-95/3D 65L		
	63~85	MT-95/3D 74L		
	70~95	MT-95/3D 83L		

Accessories

Separate mounting adapters and remote reset unit : see pages B-2-7 to B-2-8

Mounting

Direct mounting on to a contactor with lug terminals

Overload relays

Susol

Accessories

Separate mounting adapters
for 3-pole Thermal overload relays

Separate mounting adapter

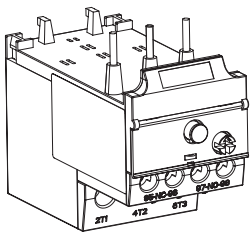

Overload relay
MT-32

Corresponding relay	Adapter type	Terminal type	Weight
			g
MT-32/3K MT-32/3H MT-32/2H MT-32/3D	UZ-32	Screw type	68
MT-63/3K MT-63/3H MT-63/2H MT-63/3D	UZ-63/S	Screw type	134
MT-63/3K MT-63/3H MT-63/2H MT-63/3D	UZ-63/L	Lug type	134
MT-95/3K MT-95/3H MT-95/2H MT-95/3D	UZ-95/S	Screw type	230
MT-95/3K MT-95/3H MT-95/2H MT-95/3D	UZ-95/L	Lug type	230

Mounting

Clip-on mounting on 35 mm  rail or screw fixing.

Overload relays

Susol

Accessories

Remote reset units for overload relays



Remote reset unit

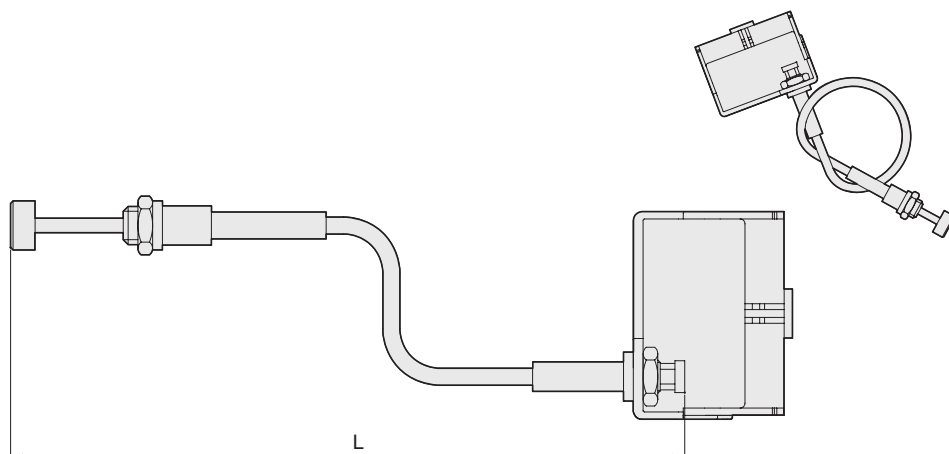

Model	L (mm)
UM-4R	400
UM-5R	500
UM-6R	600

Overload relays

Susol

Tripping characteristics

Cold starting

- MT-32/2H
- MT-32/3H
- MT-32/3K
- MT-32/3D

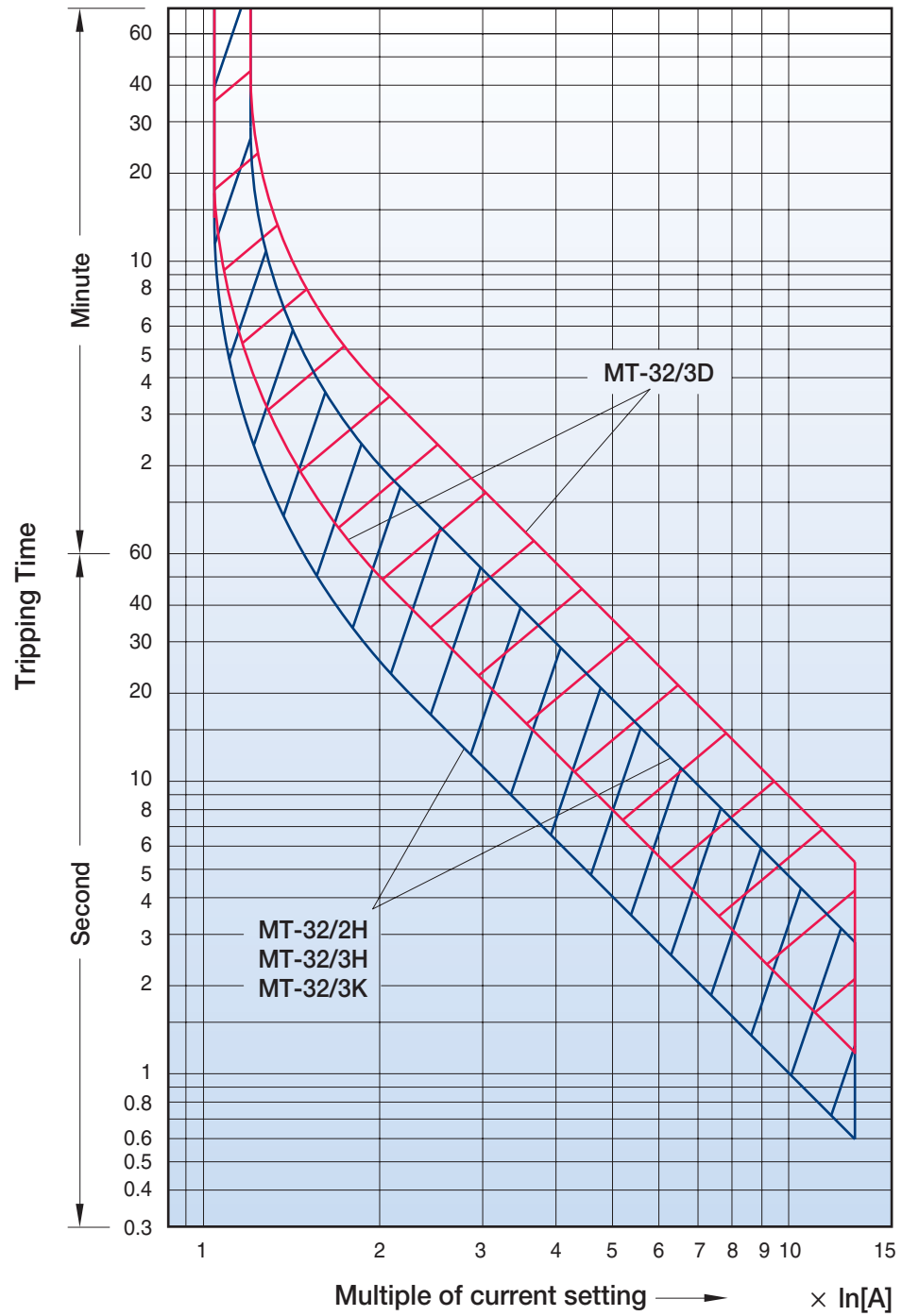

Overload relays

Susol

Tripping characteristics

Hot starting

- MT-32/2H
- MT-32/3H
- MT-32/3K
- MT-32/3D

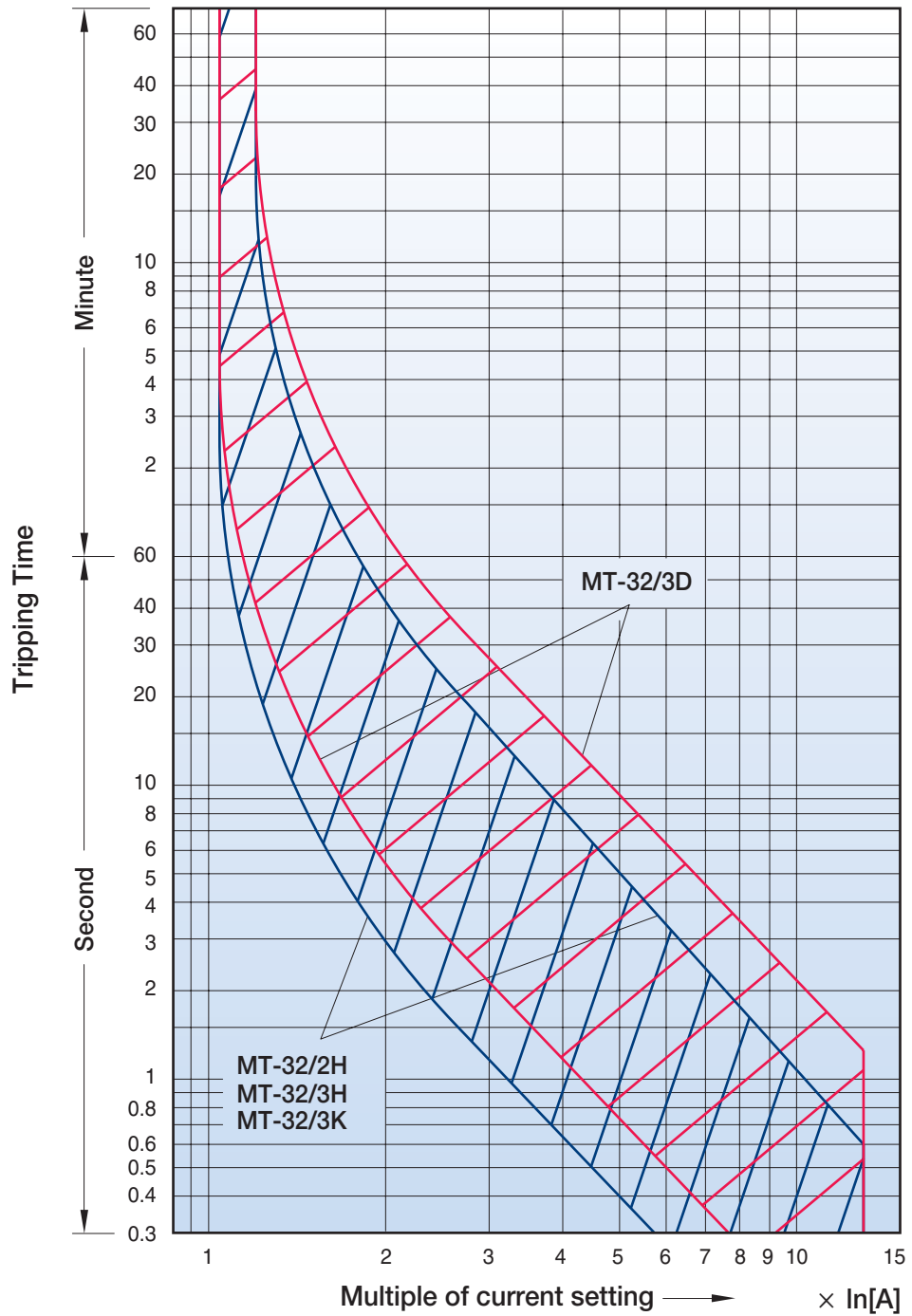

Overload relays

Susol

Tripping characteristics

Cold starting

- MT-63/2H
- MT-63/3H
- MT-63/3K
- MT-63/3D

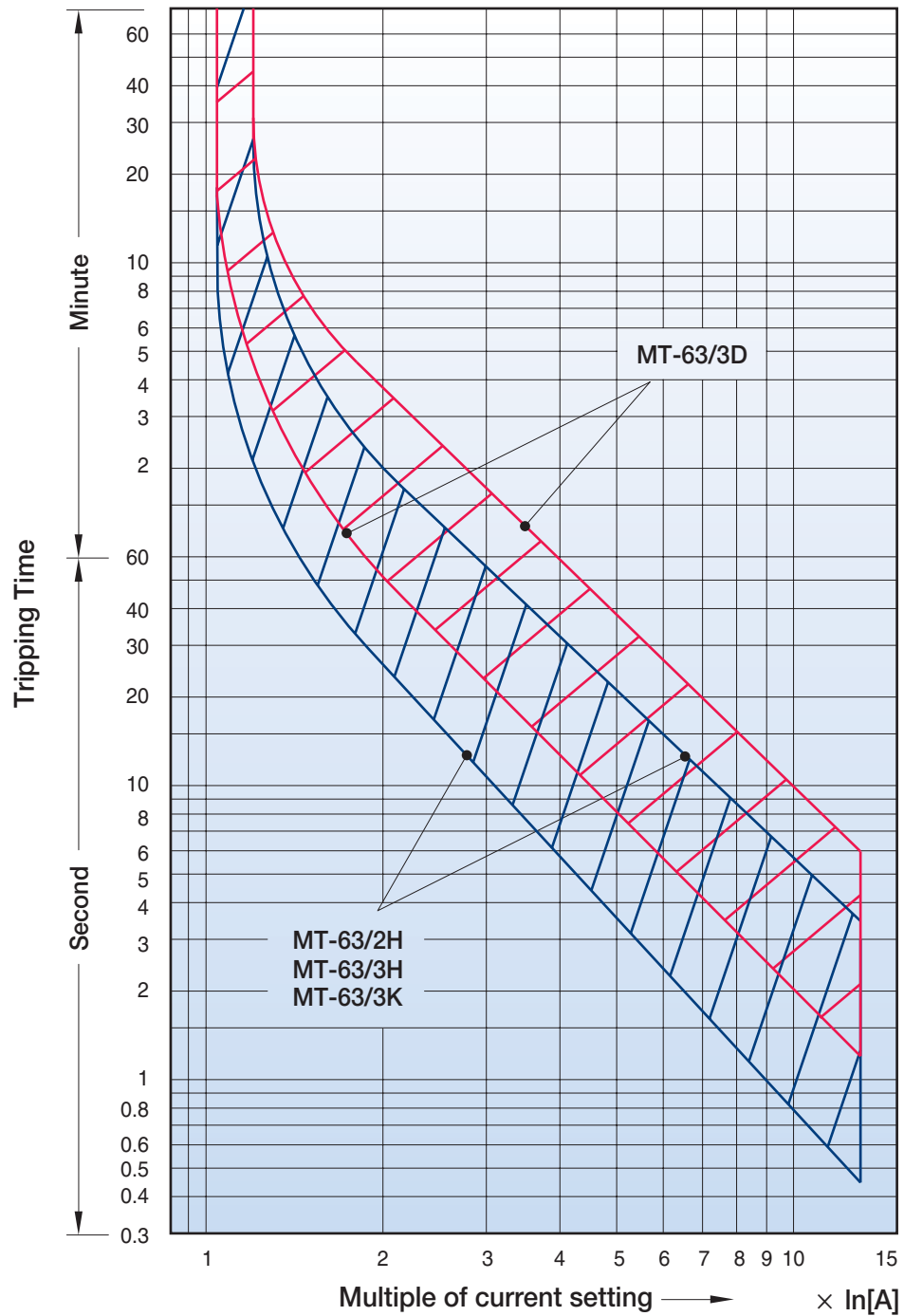

Overload relays

Susol

Tripping characteristics

Hot starting

- MT-63/2H
- MT-63/3H
- MT-63/3K
- MT-63/3D

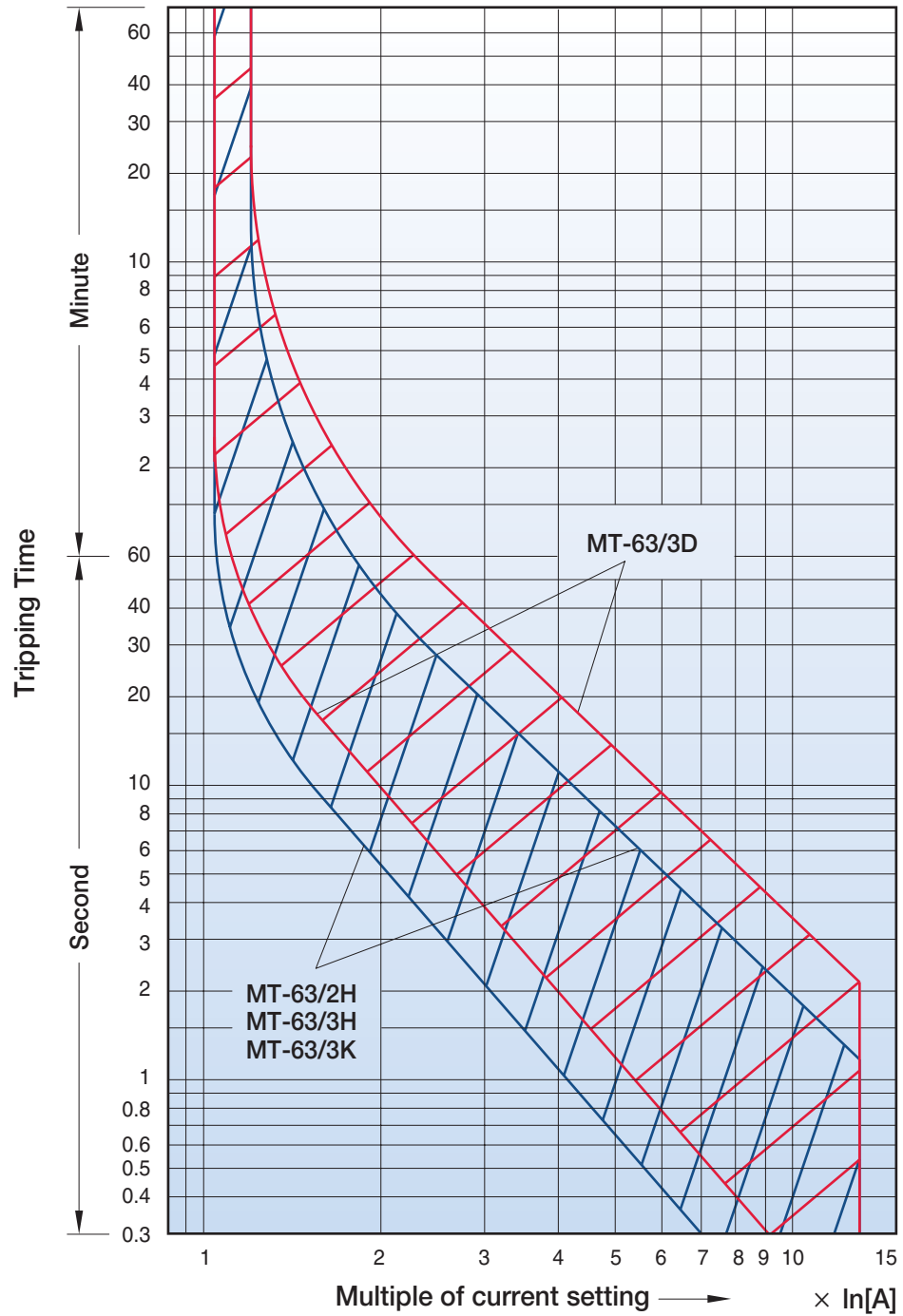

Overload relays

Susol

Tripping characteristics

Cold starting

- MT-95/2H
- MT-95/3H
- MT-95/3K
- MT-95/3D

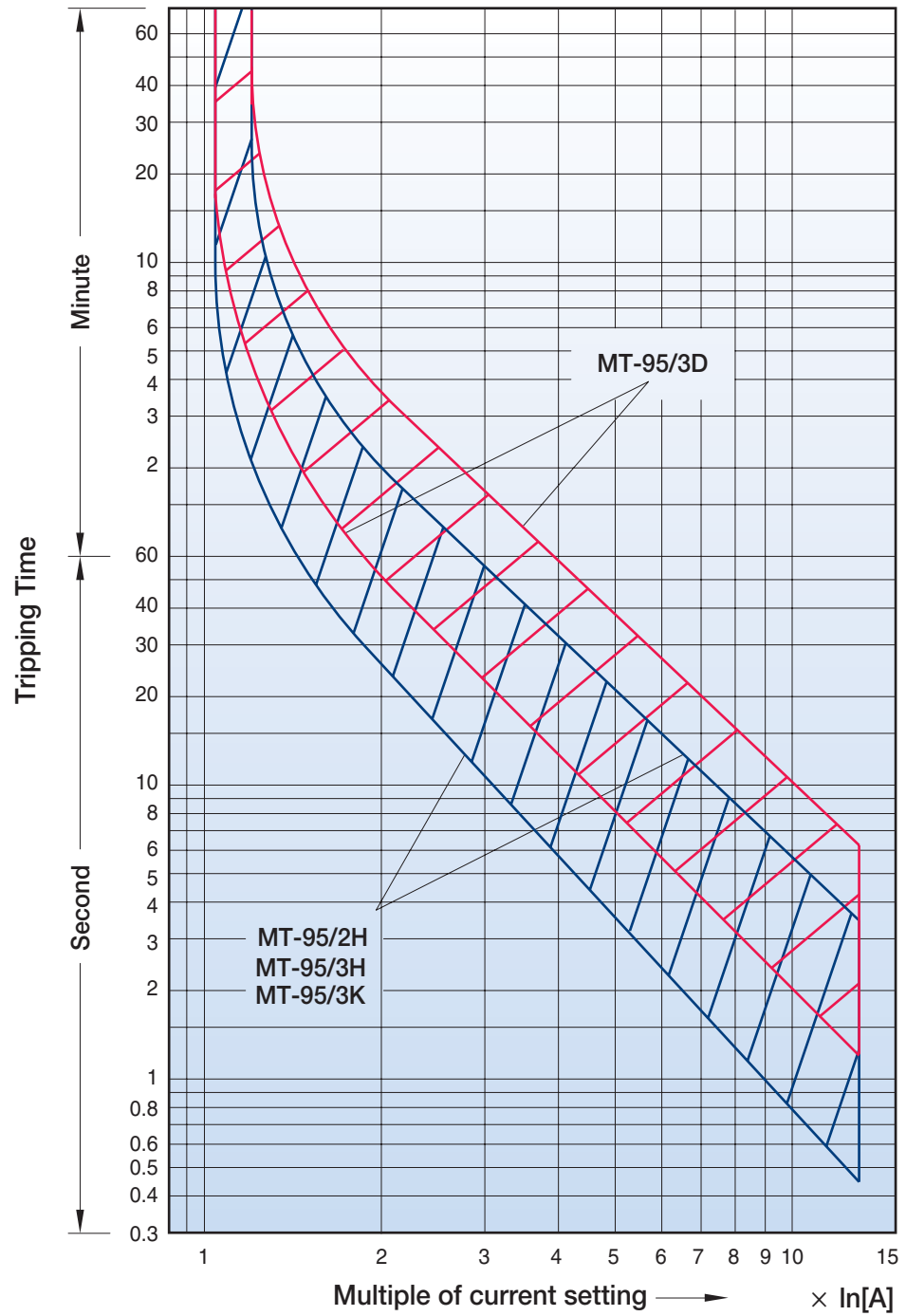

Overload relays

Susol

Tripping characteristics

Cold starting

- MT-95/2H
- MT-95/3H
- MT-95/3K
- MT-95/3D

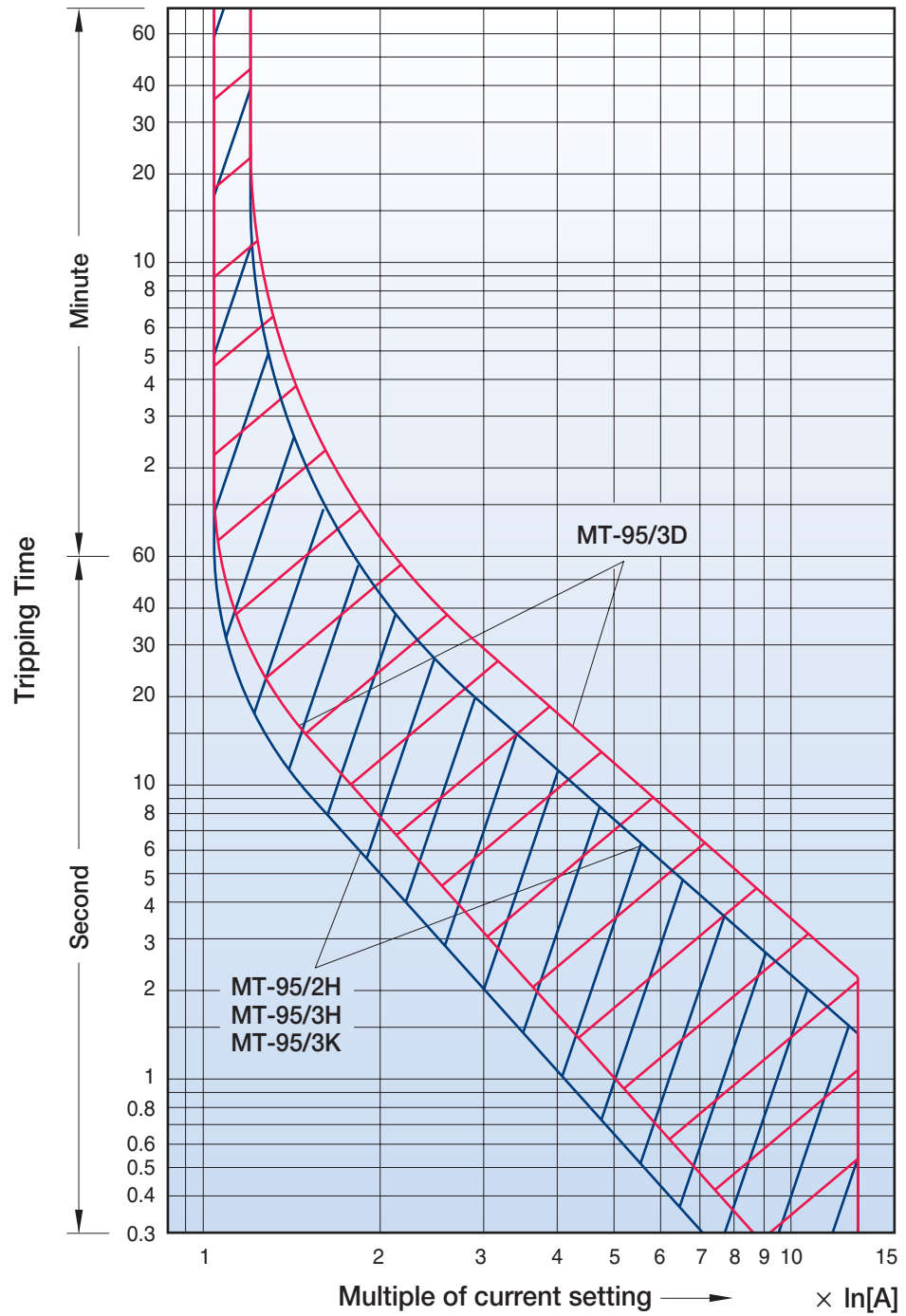



B-3. Manual motor starters

Specifications	B-3-1
Selection guide	
Standard type	B-3-3
High breaking type	B-3-4
Instantaneous type	B-3-5
Accessories	
Auxiliaries	B-3-6
Technical information	
Performance data	B-3-9
Manual motor controller	B-3-14
Manual motor controller	B-3-18
(UL 508, CSA C22.2 as Manual motor controllers)	
Manual motor controller (UL508)	B-3-20
Tripping characteristics	B-3-22
Thermal limit on short circuit	B-3-23

Manual motor starters



63AF										100AF									
MMS-63S					MMS-63H					MMS-100S					MMS-100H				
-					MMS-63HI					-					MMS-100HI				
Standard					High breaking					Standard					High breaking				
Rotary					Rotary					Rotary					Rotary				
3					3					3					3				
Up to 690V					Up to 690V					Up to 690V					Up to 690V				
50/60 Hz					50/60 Hz					50/60 Hz					50/60 Hz				
1,000V					1,000V					1,000V					1,000V				
8kV					8kV					8kV					8kV				
Cat. A					Cat. A					Cat. A					Cat. A				
AC 3					AC 3					AC 3					AC 3				
50,000					50,000					50,000					50,000				
25,000					25,000					25,000					25,000				
25					25					25					25				
-20 ~ +60°C					-20 ~ +60°C					-20 ~ +60°C					-20 ~ +60°C				
13 × I _e max.					13 × I _e max.					13 × I _e max.					13 × I _e max.				
○					○					○					○				
○					○					○					○				
x					x					○					○				
○					○					○					○				
10										22									
220V 240V 230V	415V 400V	460V 440V	525V 500V	690V 600V	220V 240V 230V	415V 400V	460V 440V	525V 500V	690V 600V	220V 240V 230V	415V 400V	460V 440V	525V 500V	690V 600V	220V 240V 230V	415V 400V	460V 440V	525V 500V	690V 600V
I _{cu}	I _{cs}	I _{cu}	I _{cs}	I _{cu}	I _{cs}	I _{cu}	I _{cs}	I _{cu}	I _{cs}	I _{cu}	I _{cs}	I _{cu}	I _{cs}	I _{cu}	I _{cs}	I _{cu}	I _{cs}	I _{cu}	I _{cs}
-	-	-	-	-	-	-	-	-	-	-	-	-	-	-	-	-	-	-	-
-	-	-	-	-	-	-	-	-	-	-	-	-	-	-	-	-	-	-	-
-	-	-	-	-	-	-	-	-	-	-	-	-	-	-	-	-	-	-	-
-	-	-	-	-	-	-	-	-	-	-	-	-	-	-	-	-	-	-	-
-	-	-	-	-	-	-	-	-	-	-	-	-	-	-	-	-	-	-	-
-	-	-	-	-	-	-	-	-	-	-	-	-	-	-	-	-	-	-	-
-	-	-	-	-	-	-	-	-	-	-	-	-	-	-	-	-	-	-	-
-	-	-	-	-	-	-	-	-	-	-	-	-	-	-	-	-	-	-	-
-	-	-	-	-	-	-	-	-	-	-	-	-	-	-	-	-	-	-	-
100	100	100	100	15	12	10	8	4	3	100	100	100	100	50	38	50	38	6	5
100	100	50	38	10	8	6	5	4	3	100	100	100	100	50	38	42	32	6	5
100	100	25	19	10	8	6	5	4	3	100	100	50	50	50	38	12	9	5	5
50	38	25	19	10	8	6	5	4	3	100	100	50	50	50	38	12	9	5	5
50	38	25	19	10	8	6	5	4	3	100	100	50	50	35	27	12	9	5	5
50	38	25	19	10	8	6	5	4	3	100	100	50	50	35	27	10	8	5	5
50	38	25	19	10	8	6	5	4	3	100	100	50	50	35	27	10	8	5	5
50	38	25	19	10	8	6	5	4	3	100	100	50	50	35	27	10	8	5	5
50	38	25	19	10	8	6	5	4	3	100	100	50	50	35	27	10	8	5	5
-	-	-	-	-	-	-	-	-	-	100	100	50	38	40	30	12	9	6	5
-	-	-	-	-	-	-	-	-	-	100	100	50	38	40	30	12	9	6	5
-	-	-	-	-	-	-	-	-	-	100	100	50	38	40	30	8	6	5	4
-	-	-	-	-	-	-	-	-	-	100	100	50	38	40	30	8	6	5	4
-	-	-	-	-	-	-	-	-	-	100	100	50	38	40	30	8	6	5	4
-	-	-	-	-	-	-	-	-	-	100	100	75	50	50	38	12	9	6	6
-	-	-	-	-	-	-	-	-	-	100	100	75	50	50	38	12	9	6	6
-	-	-	-	-	-	-	-	-	-	100	100	75	50	50	38	12	9	6	6

Manual motor starters



Selection guide

Standard type

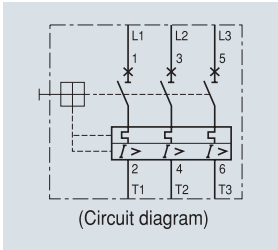

- Adjustable thermal release
- Magnetic release 13 le max.
- Trip class 10
- Ambient temperature compensation
- Protective function
 - phase-failure
 - short circuit
 - overload



Type	Rated operational current I_e [A]	Thermal release adjustment range [A]	Magnetic release operating current [A]	Switching of 3 phase AC motors, AC-2, AC-3						400/415V	
				3-phase [kW] (50/60Hz)			3-phase [HP] (60Hz)			I_{cu} [kA]	I_{cs} [kA]
				230V	400V	690V	230V	460V	575V		
MMS-32S	0.16	0.1...0.16	2.1	-	0.02	-	-	-	-	100	100
	0.25	0.16...0.25	3.3	0.03	0.06	-	-	-	-	100	100
	0.4	0.25...0.4	5.2	0.06	0.09	-	-	-	-	100	100
	0.63	0.4...0.63	8.2	0.09	0.12	0.25	-	-	-	100	100
	1	0.63...1.0	13	0.12	0.25	0.55	-	-	1/2	100	100
	1.6	1.0...1.6	20.8	0.25	0.55	1.1	-	3/4	3/4	100	100
	2.5	1.6...2.5	32.5	0.37	0.75	1.5	1/2	1 1/2	1 1/2	100	100
	4	2.5...4.0	52	0.75	1.5	3	3/4	2	3	100	100
	6	4...6	78	1.5	2.2	4	1 1/2	3	5	100	100
	8	5...8	104	1.5	3	5.5	2	5	5	100	100
	10	6...10	130	3	4	7.5	3	5	7 1/2	50	38
	13	9...13	169	3	5.5	11	3	7 1/2	10	50	38
	17	11...17	221	4	7.5	11	5	10	15	20	15
	22	14...22	286	4	7.5	15	7 1/2	15	20	15	11
26	18...26	338	5.5	11	18.5	7 1/2	15	20	15	11	
32	22...32	416	7.5	15	22	10	20	30	15	11	
MMS-63S	10	6~10	130	3	4	7.5	3	5	7 1/2	100	100
	13	9~13	169	3	5.5	11	3	7 1/2	10	50	38
	17	11~17	221	4	7.5	11	5	10	15	25	19
	22	14~22	286	4	7.5	15	7 1/2	15	20	25	19
	26	18~26	338	5.5	11	18.5	7 1/2	15	20	25	19
	32	22~32	416	7.5	15	22	10	20	30	25	19
	40	28~40	520	7.5	18.5	30	10	30	30	25	19
	50	34~50	650	11	22	45	15	30	40	25	19
63	45~63	819	15	30	55	20	40	60	25	19	
MMS-100S	17	11~17	221	4	7.5	11	5	10	15	50	38
	22	14~22	286	4	7.5	15	7 1/2	15	20	50	38
	26	18~26	338	5.5	11	18.5	7 1/2	15	20	50	38
	32	22~32	416	7.5	15	22	10	20	30	50	38
	40	28~40	520	7.5	18.5	30	10	30	30	50	38
	50	34~50	650	11	22	45	15	30	40	50	38
	63	45~63	819	15	30	55	20	40	60	50	38
	75	55~75	975	22	37	63	25	50	65	50	38
	90	70~90	1170	30	45	75	30	60	75	50	38
	100	80~100	1300	30	45	90	30	75	100	50	38

Manual motor starters



Selection guide

High breaking type

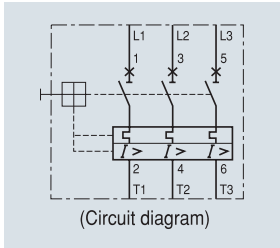

- Adjustable thermal release
- Magnetic release 13 Ie max.
- Trip class 10
- Ambient temperature compensation
- Protective function
 - phase-failure
 - short circuit
 - overload



MMS-32H



MMS-63H



MMS-100H

Type	Rated operational current Ie [A]	Thermal release adjustment range [A]	Magnetic release operating current [A]	Switching of 3 phase AC motors, AC-2, AC-3						400/415V	
				3-phase [kW] (50/60Hz)			3-phase [HP] (60Hz)			Icu [kA]	Ics [kA]
				230V	400V	690V	230V	460V	575V		
MMS-32H	0.16	0.1...0.16	2.1	-	0.02	-	-	-	-	100	100
	0.25	0.16...0.25	3.3	0.03	0.06	-	-	-	-	100	100
	0.4	0.25...0.4	5.2	0.06	0.09	-	-	-	-	100	100
	0.63	0.4...0.63	8.2	0.09	0.12	0.25	-	-	-	100	100
	1	0.63...1.0	13	0.12	0.25	0.55	-	1/2	1/2	100	100
	1.6	1.0...1.6	20.8	0.25	0.55	1.1	1/3	3/4	1	100	100
	2.5	1.6...2.5	32.5	0.37	0.75	1.5	1/2	1 1/2	1 1/2	100	100
	4	2.5...4.0	52	0.75	1.5	3	1	2	3	100	100
	6	4...6	78	1.5	2.2	4	1 1/2	5	5	100	100
	8	5...8	104	1.5	3	5.5	2	5	5	100	100
	10	6...10	130	3	4	7.5	3	7 1/2	10	100	100
	13	9...13	169	3	5.5	11	3	7 1/2	10	100	100
	17	11...17	221	4	7.5	11	5	10	15	50	38
	22	14...22	286	4	7.5	15	7 1/2	15	20	50	38
26	18...26	338	5.5	11	18.5	7 1/2	15	20	50	38	
32	22...32	416	7.5	15	22	10	20	30	50	38	
MMS-63H	10	6~10	130	3	4	7.5	3	7 1/2	10	100	100
	13	9~13	169	3	5.5	11	3	7 1/2	10	100	100
	17	11~17	221	4	7.5	11	5	10	15	50	50
	22	14~22	286	4	7.5	15	7 1/2	15	20	50	50
	26	18~26	338	5.5	11	18.5	10	20	25	50	50
	32	22~32	416	7.5	15	22	10	25	30	50	50
	40	28~40	520	7.5	18.5	30	15	30	40	50	50
	50	34~50	650	11	22	45	15	40	50	50	50
63	45~63	819	15	30	55	20	50	60	50	50	
MMS-100H	17	11~17	221	4	7.5	11	5	10	15	100	100
	22	14~22	286	4	7.5	15	7 1/2	15	20	100	50
	26	18~26	338	5.5	11	18.5	10	20	25	100	50
	32	22~32	416	7.5	15	22	10	25	30	100	50
	40	28~40	520	7.5	18.5	30	15	30	40	100	50
	50	34~50	650	11	22	45	15	40	50	100	50
	63	45~63	819	15	30	55	20	50	60	100	50
	75	55~75	975	22	37	63	25	60	75	75	50
	90	70~90	1170	30	45	75	30	75	100	75	50
	100	80~100	1300	30	45	90	40	75	100	75	50

Manual motor starters



Selection guide

Instantaneous type

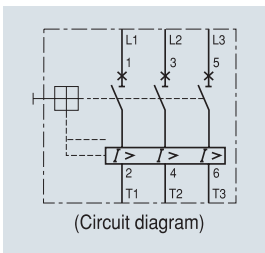

- Without thermal releases
- Magnetic release 13 I_e max.
- Protective function
 - short circuit



MMS-32HI

MMS-63HI







MMS-100HI

Type	Rated operational current I _e [A]	Thermal release adjustment range [A]	Magnetic release operating current [A]	Switching of 3 phase AC motors, AC-2, AC-3						400/415V	
				3-phase [kW] (50/60Hz)			3-phase [HP] (60Hz)			I _{cu} [kA]	I _{cs} [kA]
				230V	400V	690V	230V	460V	575V		
MMS-32HI	0.16	-	2.1	-	0.02	-	-	-	-	100	100
	0.25	-	3.3	0.03	0.06	-	-	-	-	100	100
	0.4	-	5.2	0.06	0.09	-	-	-	-	100	100
	0.63	-	8.2	0.09	0.12	0.25	-	-	-	100	100
	1	-	13	0.12	0.25	0.55	-	1/2	1/2	100	100
	1.6	-	20.8	0.25	0.55	1.1	1/3	3/4	1	100	100
	2.5	-	32.5	0.37	0.75	1.5	1/2	1 1/2	1 1/2	100	100
	4	-	52	0.75	1.5	3	1	2	3	100	100
	6	-	78	1.5	2.2	4	1 1/2	5	5	100	100
	8	-	104	1.5	3	5.5	2	5	5	100	100
	10	-	130	3	4	7.5	3	7 1/2	10	100	100
	13	-	169	3	5.5	11	3	7 1/2	10	100	100
	17	-	221	4	7.5	11	5	10	15	50	38
	22	-	286	4	7.5	15	7 1/2	15	20	50	38
26	-	338	5.5	11	18.5	7 1/2	15	20	50	38	
32	-	416	7.5	15	22	10	20	30	50	38	
MMS-63HI	10	-	130	3	4	7.5	3	7 1/2	10	100	100
	13	-	169	3	5.5	11	3	7 1/2	10	100	100
	17	-	221	4	7.5	11	5	10	15	50	50
	22	-	286	4	7.5	15	7 1/2	15	20	50	50
	26	-	338	5.5	11	18.5	10	20	25	50	50
	32	-	416	7.5	15	22	10	25	30	50	50
	40	-	520	7.5	18.5	30	15	30	40	50	50
	50	-	650	11	22	45	15	40	50	50	50
63	-	819	15	30	55	20	50	60	50	50	
MMS-100HI	17	-	221	4	7.5	11	5	10	15	100	100
	22	-	286	4	7.5	15	7 1/2	15	20	100	50
	26	-	338	5.5	11	18.5	10	20	25	100	50
	32	-	416	7.5	15	22	10	25	30	100	50
	40	-	520	7.5	18.5	30	15	30	40	100	50
	50	-	650	11	22	45	15	40	50	100	50
	63	-	819	15	30	55	20	50	60	100	50
	75	-	975	22	37	63	25	60	75	75	50
	90	-	1170	30	45	75	30	75	100	75	50
	100	-	1300	30	45	90	40	75	100	75	50

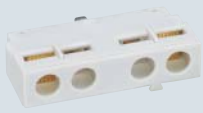
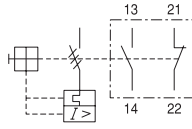
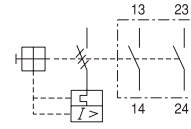
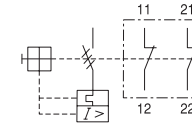
Manual motor starters

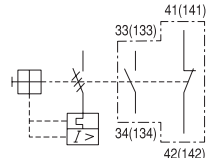
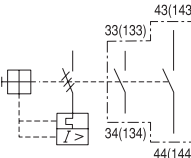
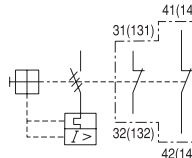

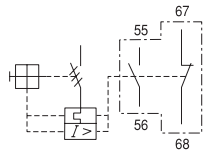
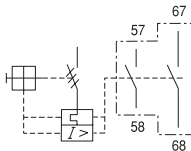
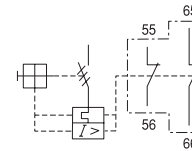
Accessories Auxiliaries

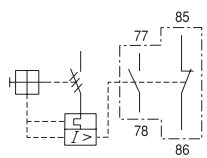
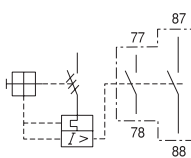
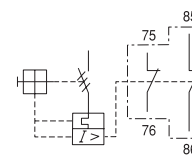



Type	Description	Connection diagram
FX... 	Auxiliary Switch <ul style="list-style-type: none"> • Front mounting • 2-pole • One front mounting module per circuit breaker 	<div style="display: flex; justify-content: space-around;"> <div style="text-align: center;"> 1NO1NC  </div> <div style="text-align: center;"> 2NO  </div> <div style="text-align: center;"> 2NC  </div> </div>
LX... 	Auxiliary Switch <ul style="list-style-type: none"> • Side mounting on the left • 2-pole • One side mounting module per circuit breaker 	<div style="display: flex; justify-content: space-around;"> <div style="text-align: center;"> 1NO1NC  </div> <div style="text-align: center;"> 2NO  </div> <div style="text-align: center;"> 2NC  </div> </div>
LA... 	Any Trip Alarm Switch <ul style="list-style-type: none"> • Operates in case of trip • Side mounting on the left • 2-pole • Set LA first in case of using LX together (MMS-63 can not accept LX and LA together) 	<div style="display: flex; justify-content: space-around;"> <div style="text-align: center;"> 1NO1NC  </div> <div style="text-align: center;"> 2NO  </div> <div style="text-align: center;"> 2NC  </div> </div>
LAM... 	Magnetic Trip Alarm Switch <ul style="list-style-type: none"> • Operates in case of instantaneous trip • Side mounting on the left • 2-pole • Set LAM first in case of using LX together 	<div style="display: flex; justify-content: space-around;"> <div style="text-align: center;"> 1NO1NC  </div> <div style="text-align: center;"> 2NO  </div> <div style="text-align: center;"> 2NC  </div> </div>

Manual motor starters



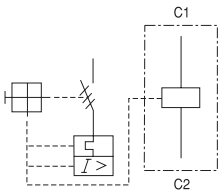

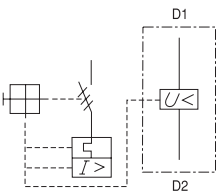
Accessories

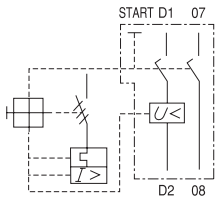
Auxiliaries

Type	Description	Connection diagram
RS... 	Shunt release <ul style="list-style-type: none"> Side mounting on the right One side mounting module per circuit breaker. Can not use with RU or RUX 	 <p>24V 50Hz / 28V 60Hz 110V 50Hz / 120V 60Hz 200V 50Hz / 200~220V 60Hz 220~230V 50Hz / 240~260V 60Hz 240V 50Hz / 277V 60Hz 380~400V 50Hz / 440~460V 60Hz 415~440V 50Hz / 460~480V 60Hz</p>
RU... 	Undervoltage release <ul style="list-style-type: none"> Side mounting on the right One side mounting module per circuit breaker. Can not use with RU or RUX 	 <p>24V 50Hz / 28V 60Hz 110V 50Hz / 120V 60Hz 200V 50Hz / 200~220V 60Hz 220~230V 50Hz / 240~260V 60Hz 240V 50Hz / 277V 60Hz 380~400V 50Hz / 440~460V 60Hz 415~440V 50Hz / 460~480V 60Hz</p>
RUX... 	Undervoltage release with Switch <ul style="list-style-type: none"> Side mounting on the right Include 2NO Auxiliary contact One side mounting module per circuit breaker. Can not use with RU or RUX Can not attach to MMS-32S 	 <p>24V 50Hz / 28V 60Hz 110V 50Hz / 120V 60Hz 200V 50Hz / 200~220V 60Hz 220~230V 50Hz / 240~260V 60Hz 240V 50Hz / 277V 60Hz 380~400V 50Hz / 440~460V 60Hz 415~440V 50Hz / 460~480V 60Hz</p>

Others

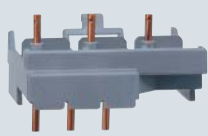
Type	Description	Applied type
IB100 	Insulation barrier Insulation barriers with increased creepage distances and clearances for UL	for MMS-100
	Dial cover to protect the set value from the operation that is not intended	for all type MMS
	Direct adaptor to connect directly with a contactor	for contactors

Manual motor starters



Accessories

Auxiliaries

Phase-bus

Phase-bus devices, Type PB, followed by MMS-32 and 63

These devices are insulated bus-bar system for feeding several modular circuit breakers on standard mounting rails.

Type	Model	Description	Applied type
Phase-bus	PB-322	For a parallel circuit 32AF	MMS-32S, 32H, 32HI
	PB-632	For a parallel circuit 63AF	MMS-63S, 32H, 32HI

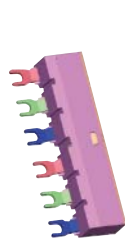

PB-322

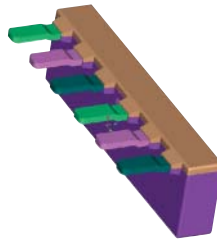

PB-632

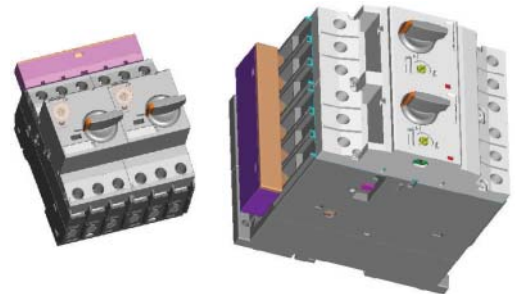

Fig.1

Mounting Unit

Phase-bus devices, Type MU, followed by MMS-32, 63 and 100

These devices are attached module to connect joined Manual Motor Starter with Contactor.

Type	Model	Description	Applied type
Mounting unit	MU-45	Width 45mm	MMS-32S/H/HI+MC-9~32 or GMC(D)-M
	MU-55	Width 55mm	MMS-63S/H/HI+MC-35~63
	MU-70	Width 70mm	MMS-100S/H/HI+MC-65~95



MU-45



MU-55



MU-70

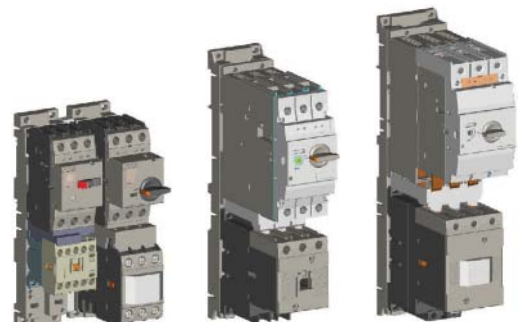

[Fig.2]





Manual motor starters



Technical information

Performance data

Terminals

		MMS-32S	MMS-32H	MMS-63S, 63H	MMS-100S, 100H
Conformity to standards		IEC60947 UL508, UL508 Type E			
Approvals		CE, UL			
Terminal parts					
Single-core	1.conductor [mm ²] / [AWG]	1...10 / 18...8	1...10 / 18...8	0.75...35 / 18...2	2.5...70 / 12...2/0
	2.conductor [mm ²] / [AWG]	1...6 / 18...10	1...6 / 18...10	0.75...25 / 18...4	2.5...50 / 12...1/0
Standard	1.conductor [mm ²] / [AWG]	1...6 / 18...10	1...6 / 18...10	0.75...35 / 18...2	2.5...70 / 12...2/0
	2.conductor [mm ²] / [AWG]	1...6 / 18...10	1...6 / 18...10	0.75...25 / 18...4	2.5...50 / 12...1/0
Flexible	1.conductor [mm ²] / [AWG]	1...6 / 18...10	1...6 / 18...10	0.75...25 / 18...4	2.5...50 / 12...1/0
	2.conductor [mm ²] / [AWG]	0.75...4 / 18...10	0.75...4 / 18...10	0.75...16 / 18...6	2.5...35 / 10...2
Tightening torque		[Nm] / [lb-in]		3...4.5 / 26...39	4...6 / 35...53

Power consumption

		MMS-32S	MMS-32H	MMS-63S, 63H	MMS-100S, 100H
Total power loss P _v					
Circuit breaker at rated load operating temperature [W]		In = 0.16~1.6A : 4.4 In = 2.5~26A : 7.4 In = 32A : 4.0	In = 0.16~1.6A : 4.4 In = 2.5~26A : 7.4 In = 32A : 4.0	In = 10~22A : 10.2 In = 26~63A : 9.7	In = 17~32A : 15 In = 40~63A : 21.8 In = 75~100A : 17.8

Mounting

35mm DIN rail for MMS32~63
35mm or 75mm DIN rail for MMS100
- use 15mm depth for 35mm DIN rail

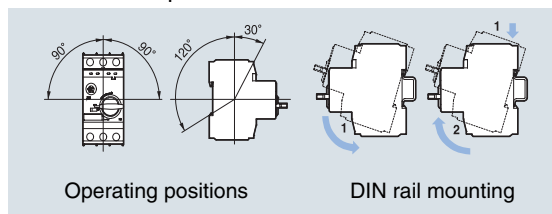

Current setting

Do not rotate the dial out of the setting range as shown below

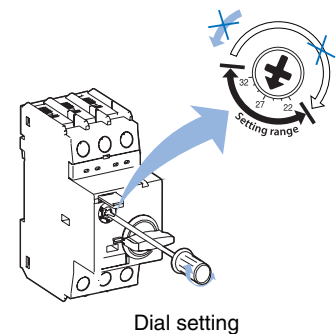

Environment

Ambient air temperature
Storage : - 50...+ 80° C
Operation : - 20...+ 60° C
Ambient temperature compensation : - 20...+ 60° C
Maximum operating altitude : 2000m
Protection degree : IP20
Shock resistance : 25g
Vibration resistance : 5~150Hz



Manual motor starters



Technical information

Performance data

Accessories

	Auxiliary contacts for front mounting FX...	Auxiliary contacts for left side mounting LX...	Alarm switch for left side mounting LA...
Rated thermal current / th at 40°C ambient temperature [A]	5	10	10
at 60°C ambient temperature [A]	3	6	6
According to NEMA (UL/CSA-Standards) AC	A 300	A 600	A 600
DC	Q 300	Q 300	Q 300
Back-up fuses gG, gL [A]	16	16	16
Rated supply current [V]	- 240	24 240	24 240
AC-15: [A]	- 3	6 4	6 4
DC-13: [V]	24 220	24 220	24 220
[A]	1 0.1	2 0.25	2 0.25
Weight [g]	18	30	40
Terminal parts		 Pozidriv size 2	
Screwdriver		Pozidriv size 2	
Single-core 1 conductor [mm ²] / [AWG]	0.5...2.5 / 20...14	0.5...2.5 / 20...14	
2 conductor [mm ²] / [AWG]	-	0.5...2.5 / 20...14	
Standard 1 conductor [mm ²] / [AWG]	0.5...4 / 20...10	0.5...4 / 20...10	
2 conductor [mm ²] / [AWG]	0.75...2.5 / 18...14	0.75...2.5 / 18...14	
Tightening torque [Nm] / [lb-in]	0.8...1.2 / 7...10	0.8...1.2 / 7...10	
	Undervoltage release for right side mounting RU...	Undervoltage release with 2 auxiliary contacts for right side mounting RUX...	Shunt release right side mounting RS...
Actuating voltage	0.7...1.1 × Us	0.85...1.1 × Us	0.85...1.1 × Us
Pull-in		0.7...0.35 × Us	0.7...0.35 × Us
Drop-out			
Rated control voltage	24V 50Hz / 28V 60Hz	24V 50Hz / 28V 60Hz	24V 50Hz / 28V 60Hz
min.:	415~440V 50Hz /	415~440V 50Hz /	415~440V 50Hz /
max.:	460~480V 60Hz	460~480V 60Hz	460~480V 60Hz
Coil rating	8.5VA, 6W	8.5VA, 6W	8.5VA, 6W
Pull-in	3VA, 1.2W	3VA, 1.2W	3VA, 1.2W
Hold			
Opening time [ms]	-	20	20
Weight [kg]	110	110	120
Terminal parts		 Pozidriv size 2	
Screwdriver		Pozidriv size 2	
Single-core 1.conductor [mm ²] / [AWG]		0.5...2.5 / 20...14	
2.conductor [mm ²] / [AWG]		0.5...2.5 / 20...14	
Standard 1.conductor [mm ²] / [AWG]	0.5...4 / 20...10	0.5...2.5 / 20...14	
2.conductor [mm ²] / [AWG]	0.75...2.5 / 18...14	0.8...1.2 / 7...10	
Tightening torque [Nm] / [lb-in]		0.8...1.2 / 7...10	

Manual motor starters



Technical information

Performance data

Installation of accessories

Be sure to turn off the main switch of MMS before any other action.

MMS-32S/H/Hi

- To install FX remove the cover ① first.
- 2 each of LX can be installed together.
- Only one of auxiliaries among RU, RS and RUX can be mounted on the right side of MMS.
- Do not give trip signal to RS longer than 10 sec.
- Refer to the possible combination chart for the mounting of LX, LA and LAM on left side of MMS.

- Push the trip button before installation of LAM

- Remove the indicated part in the fig. before the additional installation of LX

Separation of auxiliaries from MMS

- be sure to turn off the main switch of MMS before the separation.
- push softly the separation button on the side of the auxiliary and pull it.

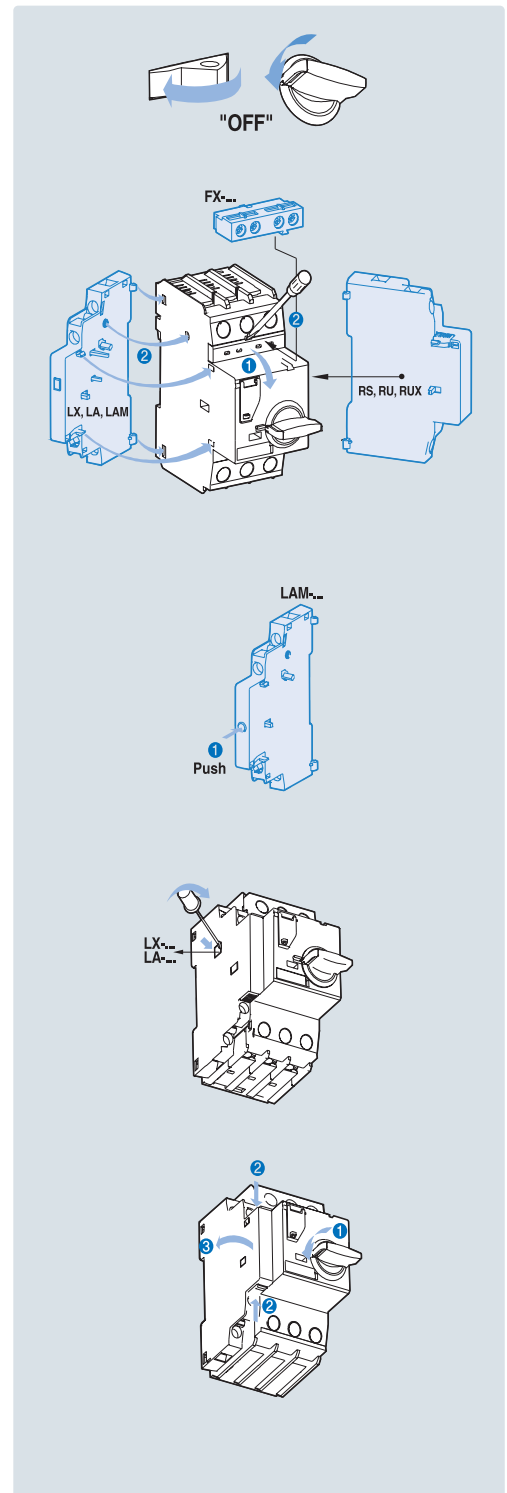

Manual motor starters



Technical information

Performance data

Installation of accessories

MMS-63, 100S/H/Hi

- To install FX remove the cover ① first.
- 2 each of LX can be installed together.
(only 1 each for MMS-63)
- Only one of auxiliaries among RU, RS and RUX can be mounted on the right side of MMS.
- Do not give trip signal to RS longer than 10 sec.
- Refer to the possible combination chart for the mounting of LX, LA and LAM on left side of MMS.

- Push the trip button before installation of LAM

- Remove the indicated part of MMS-63 and MMS-100 as shown in the fig. before the installation of LA

- Do not install LA in the status of TRIP of MMS-100

- Remove the indicated part as shown in the above fig. before the additional installation of LX

Separation of auxiliaries from MMS

- be sure to turn off the main switch of MMS before the separation.
- push softly the separation button on the side of the auxiliary and pull it.

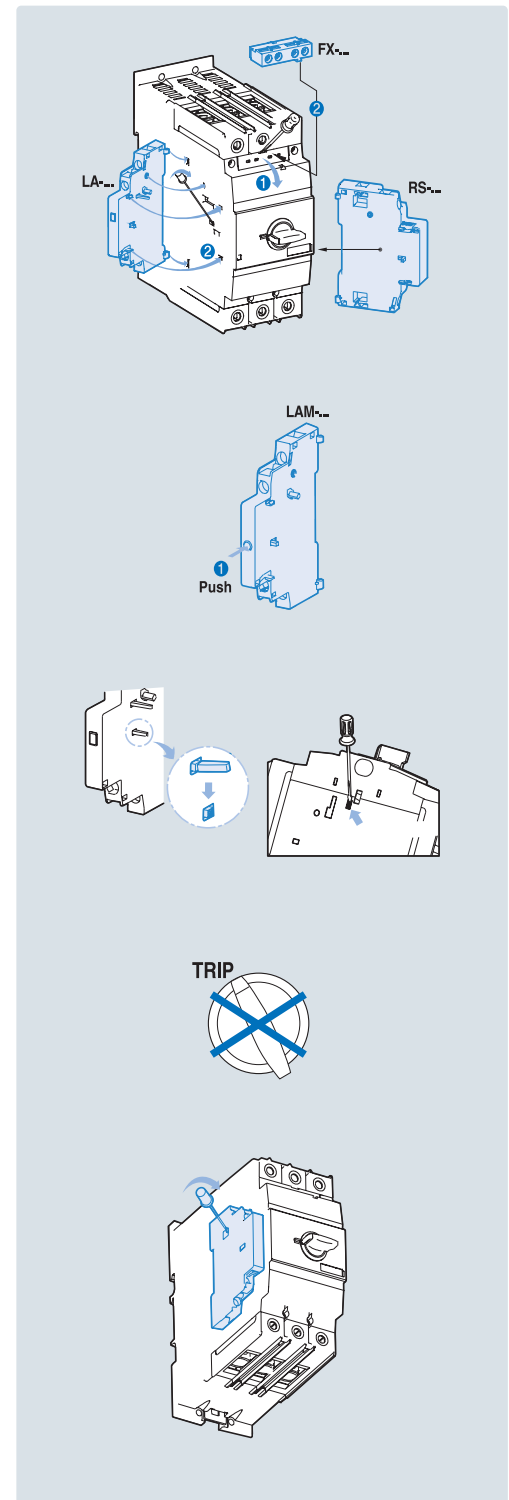

Manual motor starters



Technical information

Performance data

Installation of accessories

How to Install and reset RUX

Installing

- (1) Check if the trip button of RUX is "UP".
If not, push the side lever ① to come it up.
- (2) Fit the both lower hooks ② into the MMS.
- (3) Rotate the handle of MMS to the 20 to 30 degree ③ to ON direction and keep it.
- (4) Fit the both upper hooks ④ into the MMS.
- (5) Input power to the RUX.
- (6) Turn ON the handle of MMS.

Resetting

The trip button of RUX does not come "UP" in the event of tripping due to undervoltage.

- To turn ON the MMS after the tripping
- ① Turn OFF the MMS and check if the trip button of RUX comes "UP".
 - ② Push the trip button
 - ③ Turn ON the MMS

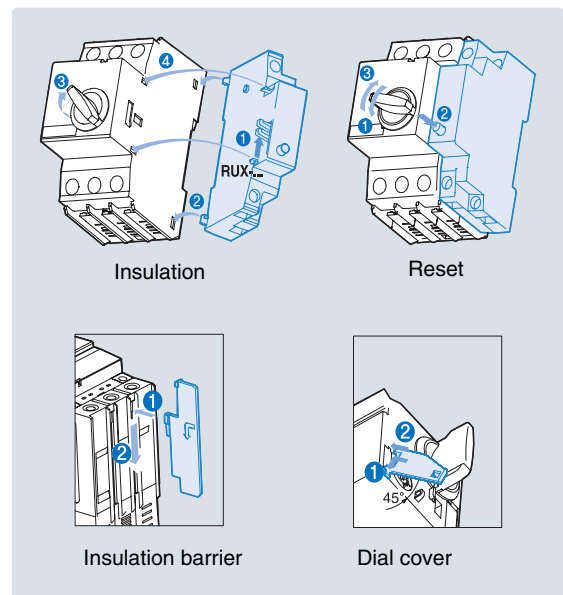

* Only for MMS-100

* For all MMS

Combination with mini contactors

Adaptor	MMS	+ Contactor model
DA-16SA	MMS-32S	+ GMC-6M~16M
DA-16SD	MMS-32S	+ GMD-6M~16M
DA-16HA	MMS-32H	+ GMC-6M~16M
DA-16HD	MMS-32H	+ GMD-6M~16M
DA-32SA	MMS-32S	+ MC-9~32
DA-32SD	MMS-32S	+ MC-9D~32D
DA-32HA	MMS-32H	+ MC-9~32
DA-32HD	MMS-32H	+ MC-9D~32D
DA-63A	MMS-63S/H	+ MC-35~63
DA-63D	MMS-63S/H	+ MC-35D~63D
DA-95A	MMS-100S/H	+ MC-65~95
DA-95D	MMS-100S/H	+ MC-65D~95D

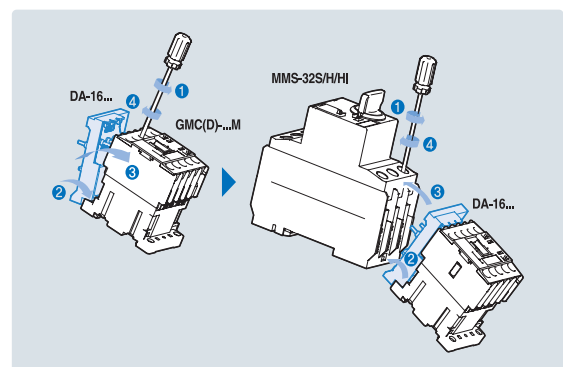

Possible combination chart

Please read this chart completely before installing the auxiliaries. Improper combination can cause electric failure or accident.

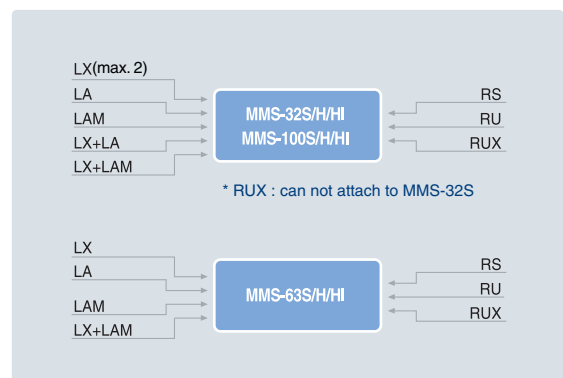

Manual motor starters



Technical information

Manual motor controller

IEC performance data (Motor protection)

Standard type MMS-32S

Rated operational current I _e [A]	0.16	0.25	0.4	0.63	1	1.6	2.5	4	6	8	10	13	17	22	26	32
Switching of standard three-phase motors AC-2, AC-3																
230/240V [kW]	-	0.03	0.06	0.09	0.12	0.18/0.25	0.37	0.55/0.75	1.1/1.5	1.5	2.2/3	3	3.7/4	4	5.5	7.5
400/415V [kW]	0.02	0.06	0.09	0.12	0.18/0.25	0.37/0.55	0.75	1.1/1.5	2.2	3	3.7/4	5.5	7.5	7.5	11	15
500V [kW]	-	-	-	0.25	0.37	0.55/0.75	1.1	1.5/2.2	3	3.7	4/5.5	7.5	11	11	15	18.5
690V [kW]	-	-	-	0.25	0.37/0.55	0.75/1.1	1.5	2.2/3	3.7/4	5.5	7.5	11	11	15	18.5	22
Back-up fuses gG, gL, only if I _{cc} >I _{cu} (* = No back up fuse required)																
230/240V [A]	*	*	*	*	*	*	*	*	*	*	*	*	*	125	125	125
400/415V [A]	*	*	*	*	*	*	*	*	*	*	80	80	100	100	100	100
440/460V [A]	*	*	*	*	*	*	*	50	50	63	63	80	80	100	100	100
500V [A]	*	*	*	*	*	*	50	40	50	63	63	80	80	80	80	80
690V [A]	*	*	*	*	*	20	35	40	50	63	63	63	63	63	63	63
Ultimate short-circuit breaking capacity I _{cu}																
230/240V [kA]	100	100	100	100	100	100	100	100	100	100	100	100	50	40	40	30
400/415V [kA]	100	100	100	100	100	100	100	100	100	100	50	50	20	15	15	15
440/460V [kA]	100	100	100	100	100	100	100	50	15	15	15	10	10	8	8	6
500V [kA]	100	100	100	100	100	100	50	15	10	10	6	6	6	6	6	5
690V [kA]	100	100	100	100	100	3	3	3	3	3	3	3	3	3	3	3
Rated service short-circuit breaking capacity I _{cs}																
230/240V [kA]	100	100	100	100	100	100	100	100	100	100	100	100	38	30	30	22
400/415V [kA]	100	100	100	100	100	100	100	100	100	100	38	38	15	11	11	11
440/460V [kA]	100	100	100	100	100	100	100	38	11	11	11	8	8	6	6	4
500V [kA]	100	100	100	100	100	100	38	11	8	8	5	5	5	5	5	4
690V [kA]	100	100	100	100	100	3	3	3	3	3	3	3	3	3	3	3

Standard type MMS-63S

Rated operational current I _e [A]	10	13	17	22	26	32	40	50	63
Switching of standard three-phase motors AC-2, AC-3									
230/240V [kW]	2.2/3	3	3.7/4	4	5.5	7.5	7.5	11	15
400/415V [kW]	3.7/4	5.5	7.5	7.5	11	15	18.5	22	30
500V [kW]	4/5.5	7.5	11	11	15	18.5	22	30	37
690V [kW]	7.5	11	11	15	18.5	22	30	45	55
Back-up fuses gG, gL, only if I _{cc} >I _{cu} (* = No back up fuse required)									
230/240V [A]	*	*	*	125	125	160	160	160	200
400/415V [A]	*	80	100	125	125	125	125	160	160
440/460V [A]	80	80	100	100	100	100	100	100	125
500V [A]	80	80	80	80	80	80	80	80	80
690V [A]	63	63	63	63	63	63	63	63	80
Ultimate short-circuit breaking capacity I _{cu}									
230/240V [kA]	100	100	100	50	50	50	50	50	50
400/415V [kA]	100	50	25	25	25	25	25	25	25
440/460V [kA]	15	10	10	10	10	10	10	10	10
500V [kA]	10	6	6	6	6	6	6	6	6
690V [kA]	4	4	4	4	4	4	4	4	4
Rated service short-circuit breaking capacity I _{cs}									
230/240V [kA]	100	100	100	38	38	38	38	38	38
400/415V [kA]	100	38	19	19	19	19	19	19	19
440/460V [kA]	12	8	8	8	8	8	8	8	8
500V [kA]	8	5	5	5	5	5	5	5	5
690V [kA]	3	3	3	3	3	3	3	3	3

Manual motor starters



Technical information

Manual motor controller

IEC performance data (Motor protection)

Standard type MMS-100S

Rated operational current I _e [A]	17	22	26	32	40	50	63	75	90	100
Switching of standard three-phase motors AC-2, AC-3										
230/240V [kW]	3.7/4	4	5.5	7.5	7.5	11	15	22	30	30
400/415V [kW]	7.5	7.5	11	15	18.5	22	30	37	45	45
500V [kW]	11	11	15	18.5	22	30	37	45	55	63
690V [kW]	11	15	18.5	22	30	45	55	63	75	90
Back-up fuses gG, gL, only if I _{cc} >I _{cu} (* = No back up fuse required)										
230/240V [A]	*	*	*	*	*	*	*	*	*	*
400/415V [A]	100	125	125	125	160	160	160	160	160	160
440/460V [A]	100	125	125	125	125	125	160	160	160	160
500V [A]	100	100	100	100	100	100	100	125	125	125
690V [A]	63	80	80	80	80	80	80	100	125	125
Ultimate short-circuit breaking capacity I _{cu}										
230/240V [kA]	100	100	100	100	100	100	100	100	100	100
400/415V [kA]	50	50	50	50	50	50	50	50	50	50
440/460V [kA]	40	40	40	40	40	40	40	40	40	40
500V [kA]	25	25	25	15	15	12	12	8	8	8
690V [kA]	10	10	10	10	6	6	6	5	5	5
Rated service short-circuit breaking capacity I _{cs}										
230/240V [kA]	100	100	100	100	100	100	100	100	100	100
400/415V [kA]	38	38	38	38	38	38	38	38	38	38
440/460V [kA]	30	30	30	30	30	30	30	30	30	30
500V [kA]	19	19	19	11	11	9	9	6	6	6
690V [kA]	8	8	8	8	5	5	5	4	4	4

High breaking type MMS-32H

Rated operational current I _e [A]	0.16	0.25	0.4	0.63	1	1.6	2.5	4	6	8	10	13	17	22	26	32
Switching of standard three-phase motors AC-2, AC-3																
230/240V [kW]	-	0.03	0.06	0.09	0.12	0.18/0.25	0.37	0.55/0.75	1.1/1.5	1.5	2.2/3	3	3.7/4	4	5.5	7.5
400/415V [kW]	0.02	0.06	0.09	0.12	0.18/0.25	0.37/0.55	0.75	1.1/1.5	2.2	3	3.7/4	5.5	7.5	7.5	11	15
500V [kW]	-	-	-	0.25	0.37	0.55/0.75	1.1	1.5/2.2	3	3.7	4/5.5	7.5	11	11	15	18.5
690V [kW]	-	-	-	0.25	0.37/0.55	0.75/1.1	1.5	2.2/3	3.7/4	5.5	7.5	11	11	15	18.5	22
Back-up fuses gG, gL, only if I _{cc} >I _{cu} (* = No back up fuse required)																
230/240V [A]	*	*	*	*	*	*	*	*	*	*	*	*	*	125	125	125
400/415V [A]	*	*	*	*	*	*	*	*	*	*	80	80	100	100	100	100
440/460V [A]	*	*	*	*	*	*	*	50	50	63	63	80	80	100	100	100
500V [A]	*	*	*	*	*	50	40	50	63	63	80	80	80	80	80	80
690V [A]	*	*	*	*	20	35	40	50	63	63	63	63	63	63	63	63
Ultimate short-circuit breaking capacity I _{cu}																
230/240V [kA]	100	100	100	100	100	100	100	100	100	100	100	100	50	40	40	30
400/415V [kA]	100	100	100	100	100	100	100	100	100	100	50	50	20	15	15	15
440/460V [kA]	100	100	100	100	100	100	100	50	15	15	15	10	10	8	8	6
500V [kA]	100	100	100	100	100	100	50	15	10	10	6	6	6	6	6	5
690V [kA]	100	100	100	100	100	3	3	3	3	3	3	3	3	3	3	3
Rated service short-circuit breaking capacity I _{cs}																
230/240V [kA]	100	100	100	100	100	100	100	100	100	100	100	38	30	30	30	22
400/415V [kA]	100	100	100	100	100	100	100	100	100	100	38	38	15	11	11	11
440/460V [kA]	100	100	100	100	100	100	100	38	11	11	11	8	8	6	6	4
500V [kA]	100	100	100	100	100	100	38	11	8	8	5	5	5	5	5	4
690V [kA]	100	100	100	100	100	3	3	3	3	3	3	3	3	3	3	3

Note) * = Short circuit proof up to 50 or 100kA. No back up fuse required.

Manual motor starters



Technical information

Manual motor controller

IEC performance data (Motor protection)

High breaking type MMS-63H



Rated operational current Ie [A]		10	13	17	22	26	32	40	50	63
Switching of standard three-phase motors AC-2, AC-3										
230/240V [kW]		2.2/3	3	3.7/4	4	5.5	7.5	7.5	11	15
400/415V [kW]		3.7/4	5.5	7.5	7.5	11	15	18.5	22	30
500V [kW]		4/5.5	7.5	11	11	15	18.5	22	30	37
690V [kW]		7.5	11	11	15	18.5	22	30	45	55
Back-up fuses gG, gL., only if Icc > Icu (* = No back up fuse required)										
230/240V [A]		*	*	*	*	*	*	*	*	*
400/415V [A]		*	*	100	125	125	125	160	160	160
440/460V [A]		100	100	100	125	125	125	125	125	160
500V [A]		100	100	100	100	100	100	100	100	100
690V [A]		63	63	63	80	80	80	80	80	80
Ultimate short-circuit breaking capacity Icu										
230/240V [kA]		100	100	100	100	100	100	100	100	100
400/415V [kA]		100	100	50	50	50	50	50	50	50
440/460V [kA]		50	50	50	50	35	35	35	35	35
500V [kA]		50	42	12	12	12	10	10	10	10
690V [kA]		6	6	5	5	5	5	5	5	5
Rated service short-circuit breaking capacity Ics										
230/240V [kA]		100	100	100	100	100	100	100	100	100
400/415V [kA]		100	100	50	50	50	50	50	50	50
440/460V [kA]		38	38	38	38	27	27	27	27	27
500V [kA]		38	32	9	9	9	8	8	8	8
690V [kA]		5	5	5	5	5	5	5	5	5

Note) * = Short circuit proof up to 50 or 100kA. No back up fuse required.

High breaking type MMS-100H



Rated operational current Ie [A]		17	22	26	32	40	50	63	75	90	100
Switching of standard three-phase motors AC-2, AC-3											
230/240V [kW]		3.7/4	4	5.5	7.5	7.5	11	15	22	30	30
400/415V [kW]		7.5	7.5	11	15	18.5	22	30	37	45	45
500V [kW]		11	11	15	18.5	22	30	37	45	55	63
690V [kW]		11	15	18.5	22	30	45	55	63	75	90
Back-up fuses gG, gL., only if Icc > Icu (* = No back up fuse required)											
230/240V [A]		*	*	*	*	*	*	*	*	*	*
400/415V [A]		*	*	*	*	*	*	*	*	*	*
440/460V [A]		125	125	125	160	160	160	200	200	200	200
500V [A]		100	125	125	125	160	160	160	160	160	160
690V [A]		80	80	80	80	80	100	100	125	160	160
Ultimate short-circuit breaking capacity Icu											
230/240V [kA]		100	100	100	100	100	100	100	100	100	100
400/415V [kA]		100	100	100	100	100	100	100	75	75	75
440/460V [kA]		50	50	50	50	50	50	50	50	50	50
500V [kA]		35	35	35	25	20	15	15	12	12	12
690V [kA]		12	12	12	12	12	10	8	6	6	6
Rated service short-circuit breaking capacity Ics											
230/240V [kA]		100	100	100	100	100	100	100	100	100	100
400/415V [kA]		100	50	50	50	50	50	50	50	50	50
440/460V [kA]		38	38	38	38	38	38	38	38	38	38
500V [kA]		27	27	27	19	15	11	11	9	9	9
690V [kA]		9	9	9	9	9	8	6	6	6	6

Note) * = Short circuit proof up to 50 or 100kA. No back up fuse required.

Manual motor starters



Technical information

Manual motor controller

IEC performance data (Motor protection)

Instantaneous type MMS-32HI

Rated operational current Ie [A]	0.16	0.25	0.4	0.63	1	1.6	2.5	4	6	8	10	13	17	22	26	32
AC-2, AC-3																
230/240V [kW]	-	0.03	0.06	0.09	0.12	0.18/0.25	0.37	0.55/0.75	1.1/1.5	1.5	2.2/3	3	3.7/4	4	5.5	7.5
400/415V [kW]	0.02	0.06	0.09	0.12	0.18/0.25	0.37/0.55	0.75	1.1/1.5	2.2	3	3.7/4	5.5	7.5	7.5	11	15
500V [kW]	-	-	-	0.25	0.37	0.55/0.75	1.1	1.5/2.2	3	3.7	4/5.5	7.5	11	11	15	18.5
690V [kW]	-	-	-	0.25	0.37/0.55	0.75/1.1	1.5	2.2/3	3.7/4	5.5	7.5	11	11	15	18.5	22
Back-up fuses gG, gL, only if Icc>Icu (* = No back up fuse required)																
230/240V [A]	*	*	*	*	*	*	*	*	*	*	*	*	*	*	*	*
400/415V [A]	*	*	*	*	*	*	*	*	*	*	*	*	100	125	125	125
440/460V [A]	*	*	*	*	*	*	*	*	*	80	80	80	80	100	100	100
500V [A]	*	*	*	*	*	*	*	*	*	63	80	80	80	80	80	80
690V [A]	*	*	*	*	*	*	35	40	50	63	63	63	63	63	63	63
Ultimate short-circuit breaking capacity Icu [kA]																
230/240V [kA]	100	100	100	100	100	100	100	100	100	100	100	100	100	100	100	100
400/415V [kA]	100	100	100	100	100	100	100	100	100	100	100	100	50	50	50	50
440/460V [kA]	100	100	100	100	100	100	100	100	100	50	50	50	20	20	20	20
500V [kA]	100	100	100	100	100	100	100	100	100	50	50	42	10	10	10	10
690V [kA]	100	100	100	100	100	100	8	8	6	6	6	6	4	4	4	4
Rated service short-circuit breaking capacity Ics [kA]																
230/240V [kA]	100	100	100	100	100	100	100	100	100	100	100	100	100	100	100	100
400/415V [kA]	100	100	100	100	100	100	100	100	100	100	100	100	38	38	38	38
440/460V [kA]	100	100	100	100	100	100	100	100	100	38	38	38	15	15	15	15
500V [kA]	100	100	100	100	100	100	100	100	100	38	38	32	8	8	8	8
690V [kA]	100	100	100	100	100	100	8	8	6	6	6	6	4	4	4	4

Instantaneous type MMS-63HI

Rated operational current Ie [A]	10	13	17	22	26	32	40	50	63
AC-2, AC-3									
230/240V [kW]	2.2/3	3	3.7/4	4	5.5	7.5	7.5	11	15
400/415V [kW]	3.7/4	5.5	7.5	7.5	11	15	18.5	22	30
500V [kW]	4/5.5	7.5	11	11	15	18.5	22	30	37
690V [kW]	7.5	11	11	15	18.5	22	30	45	55
Back-up fuses gG, gL, only if Icc>Icu (* = No back up fuse required)									
230/240V [A]	*	*	*	*	*	*	*	*	*
400/415V [A]	*	*	100	125	125	125	160	160	160
440/460V [A]	100	100	100	125	125	125	125	125	160
500V [A]	100	100	100	100	100	100	100	100	100
690V [A]	63	63	63	80	80	80	80	80	80
Ultimate short-circuit breaking capacity Icu [kA]									
230/240V [kA]	100	100	100	100	100	100	100	100	100
400/415V [kA]	100	100	50	50	50	50	50	50	50
440/460V [kA]	50	50	50	50	35	35	35	35	35
500V [kA]	50	42	12	12	10	10	10	10	10
690V [kA]	6	6	5	5	5	5	5	5	5
Rated service short-circuit breaking capacity Ics [kA]									
230/240V [kA]	100	100	100	100	100	100	100	100	100
400/415V [kA]	100	100	50	50	50	50	50	50	50
440/460V [kA]	38	38	38	38	27	27	27	27	27
500V [kA]	38	32	9	9	9	8	8	8	8
690V [kA]	5	5	5	5	5	5	5	5	5

Instantaneous type MMS-100HI

Rated operational current Ie [A]	17	22	26	32	40	50	63	75	90	100
AC-2, AC-3										
230/240V [kW]	3.7/4	4	5.5	7.5	7.5	11	15	22	30	30
400/415V [kW]	7.5	7.5	11	15	18.5	22	30	37	45	45
500V [kW]	11	11	15	18.5	22	30	37	45	55	63
690V [kW]	11	15	18.5	22	30	45	55	63	75	9
Back-up fuses gG, gL, only if Icc>Icu (* = No back up fuse required)										
230/240V [A]	*	*	*	*	*	*	*	*	*	*
400/415V [A]	*	*	*	*	*	*	*	*	*	*
440/460V [A]	125	125	125	160	160	160	200	200	200	200
500V [A]	100	125	125	125	160	160	160	160	160	160
690V [A]	80	80	80	80	80	100	100	125	160	160
Ultimate short-circuit breaking capacity Icu [kA]										
230/240V [kA]	100	100	100	100	100	100	100	100	100	100
400/415V [kA]	100	100	100	100	100	100	100	75	75	75
440/460V [kA]	50	50	50	50	50	50	50	50	50	50
500V [kA]	35	35	35	25	20	15	15	12	12	12
690V [kA]	12	12	12	12	12	10	8	6	6	6
Rated service short-circuit breaking capacity Ics [kA]										
230/240V [kA]	100	100	100	100	100	100	100	100	100	100
400/415V [kA]	100	50	50	50	50	50	50	50	50	50
440/460V [kA]	38	38	38	38	38	38	38	38	38	38
500V [kA]	27	27	27	19	15	11	11	9	9	9
690V [kA]	9	9	9	9	9	8	6	6	6	6

Manual motor starters



Technical information

Manual motor controller

(UL 508, CSA C22.2 as Manual motor controllers)

Combination Motor Controller

- Group Installation
- Type E starter

MMS-32S

Rated operational current I _e [A]	0.16	0.25	0.4	0.63	1	1.6	2.5	4	6	8	10	13	17	22	26	32
Max. short-circuit current																
240V [kA]	100	100	100	100	100	100	100	100	100	100	50	50	40	30	30	20
480V [kA]	50	50	50	50	50	50	50	50	25	25	10	10	10	10	7.5	7.5
600V [kA]	10	10	10	10	10	10	10	5	5	5	5	5	5	5	5	5
Motor load																
1 Phase 115V [HP]	-	-	-	-	-	-	-	1/8	1/4	1/3	1/2	1/2	1	1 1/2	2	2
230V [HP]	-	-	-	-	-	1/10	1/6	1/3	1/2	1	1 1/2	2	3	3	3	5
3 Phase 200V [HP]	-	-	-	-	-	-	1/2	3/4	1	2	2	3	3	5	7 1/2	7 1/2
230V [HP]	-	-	-	-	-	-	1/2	3/4	1 1/2	2	3	3	5	7 1/2	7 1/2	10
460V [HP]	-	-	-	-	-	3/4	1	2	3	5	5	7 1/2	10	15	15	20
575V [HP]	-	-	-	-	1/2	3/4	1 1/2	3	5	5	7 1/2	10	15	20	20	30
Maximum rated current [A]																
of fuse or breaker	15	15	15	15	15	15	15	20	30	40	50	60	80	100	125	125

MMS-63S

Rated operational current I _e [A]	10	13	17	22	26	32	40	50	63
Max. short-circuit current									
240V [kA]	100	100	100	100	100	100	100	100	100
480V [kA]	50	50	40	40	40	40	40	40	40
600V [kA]	10	10	10	10	10	10	10	10	10
Motor load									
1 Phase 115V [HP]	1/2	1/2	1	1 1/2	2	2	3	3	5
230V [HP]	1 1/2	2	3	3	3	5	7 1/2	10	10
3 Phase 200V [HP]	2	3	3	5	7 1/2	7 1/2	10	15	20
230V [HP]	3	3	5	7 1/2	7 1/2	10	10	15	20
460V [HP]	5	7 1/2	10	15	15	20	30	30	40
575V [HP]	7 1/2	10	15	20	20	30	30	40	60
Maximum rated current [A]									
of fuse or breaker	600	600	600	600	600	600	600	600	600

MMS-100S

Rated operational current I _e [A]	17	22	26	32	40	50	63	75	90	100
Max. short-circuit current										
240V [kA]	100	100	100	100	100	100	100	100	100	100
480V [kA]	50	50	50	50	50	50	40	40	40	40
600V [kA]	10	10	10	10	10	10	10	10	10	10
Motor load										
1 Phase 115V [HP]	1	1 1/2	2	2	3	3	5	5	7 1/2	10
230V [HP]	3	3	3	5	7 1/2	10	10	15	20	20
3 Phase 200V [HP]	3	5	7 1/2	7 1/2	10	15	20	20	25	30
230V [HP]	5	7 1/2	7 1/2	10	10	15	20	25	30	30
460V [HP]	10	15	15	20	30	30	40	50	60	75
575V [HP]	15	20	20	30	30	40	60	60	75	100
Maximum rated current [A]										
of fuse or breaker	1000	1000	1000	1000	1000	1000	1000	1000	1000	1000

In case of 1-phase use in series as shown below

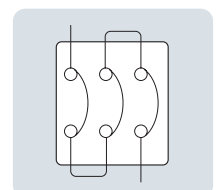

Manual motor starters



Technical information

Manual motor controller

(UL 508, CSA C22.2 as Manual motor controllers)

Combination Motor Controller

- Group Installation
- Type E starter

MMS-32H

Rated operational current I _e [A]	0.16	0.25	0.4	0.63	1	1.6	2.5	4	6	8	10	13	17	22	26	32
Max. short-circuit current																
240V [kA]	100	100	100	100	100	100	100	100	100	100	100	100	100	100	100	100
480V [kA]	65	65	65	65	65	65	65	65	65	65	65	65	30	30	30	30
600V [kA]	25	25	25	25	25	25	25	25	25	25	25	25	10	10	10	10
Motor load																
1 Phase 115V [HP]	-	-	-	-	-	-	-	1/8	1/4	1/3	1/2	1/2	1	1 ½	2	2
230V [HP]	-	-	-	-	-	1/10	1/6	1/3	1/2	1	1 ½	2	3	3	3	5
3 Phase 200V [HP]	-	-	-	-	-	-	1/2	3/4	1	2	2	3	3	5	7 ½	7 ½
230V [HP]	-	-	-	-	-	-	1/2	3/4	1 ½	2	3	3	5	7 ½	7 ½	10
460V [HP]	-	-	-	-	3/4	1	2	3	5	5	7 ½	10	15	15	20	
575V [HP]	-	-	-	-	1/2	3/4	1 ½	3	5	5	7 ½	10	15	20	20	30
Maximum rated current of fuse or breaker [A]	500	500	500	500	500	500	500	500	500	500	500	500	500	500	500	500

MMS-63H

Rated operational current I _e [A]	10	13	17	22	26	32	40	50	63
Max. short-circuit current									
240V [kA]	100	100	100	100	100	100	100	100	100
480V [kA]	65	65	50	50	50	50	50	50	50
600V [kA]	25	25	10	10	10	10	10	10	10
Motor load									
1 Phase 115V [HP]	1/2	1/2	1	1 ½	2	2	3	3	5
230V [HP]	1 ½	2	3	3	3	5	7 ½	10	10
3 Phase 200V [HP]	2	3	3	5	7 ½	7 ½	10	15	20
230V [HP]	3	3	5	7 ½	7 ½	10	10	15	20
460V [HP]	5	7 ½	10	15	15	20	30	30	40
575V [HP]	7 ½	10	15	20	20	30	30	40	60
Maximum rated current of fuse or breaker [A]	600	600	600	600	600	600	600	600	600

MMS-100H

Rated operational current I _e [A]	17	22	26	32	40	50	63	75	90	100
Max. short-circuit current										
240V [kA]	100	100	100	100	100	100	100	100	100	100
480V [kA]	65	65	65	65	65	65	50	50	50	50
600V [kA]	25	25	25	20	20	20	10	10	10	10
Motor load										
1 Phase 115V [HP]	1	1 ½	2	2	3	3	5	5	7 ½	10
230V [HP]	3	3	3	5	7 ½	10	10	15	20	20
3 Phase 200V [HP]	3	5	7 ½	7 ½	10	15	20	20	25	30
230V [HP]	5	7 ½	7 ½	10	10	15	20	25	30	30
460V [HP]	10	15	15	20	30	30	40	50	60	75
575V [HP]	15	20	20	30	30	40	60	60	75	100
Maximum rated current of fuse or breaker [A]	1000	1000	1000	1000	1000	1000	1000	1000	1000	1000

In case of 1-phase use in series as shown below

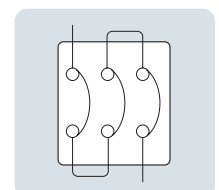

Manual motor starters



Technical information

Manual motor controller (UL508)

MMS-32S

Rated operational current I _e [A]	0.16	0.25	0.4	0.63	1	1.6	2.5	4	6	8	10	13	17	22	26	32
Max. short-circuit current																
240V [kA]	100	100	100	100	100	100	100	100	100	100	50	50	40	30	30	20
480V [kA]	50	50	50	50	50	50	50	50	25	25	10	10	10	10	7.5	7.5
600V [kA]	10	10	10	10	10	10	10	5	5	5	5	5	5	5	5	5
Motor load																
1 Phase 115V [HP]	-	-	-	-	-	-	-	1/8	1/4	1/3	1/2	1/2	1	1 ½	2	2
230V [HP]	-	-	-	-	-	1/10	1/6	1/3	1/2	1	1 ½	2	3	3	3	5
3 Phase 200V [HP]	-	-	-	-	-	-	1/2	3/4	1	2	2	3	3	5	7 ½	7 ½
230V [HP]	-	-	-	-	-	-	1/2	3/4	1 ½	2	3	3	5	7 ½	7 ½	10
460V [HP]	-	-	-	-	-	3/4	1	2	3	5	5	7 ½	10	15	15	20
575V [HP]	-	-	-	-	1/2	3/4	1 ½	3	5	5	7 ½	10	15	20	20	30
Max. Fuse size [A]	1	1	1	1	3	6	10	15	20	30	40	50	60	80	100	125
Max. Breaker size [A]	15	15	15	15	15	15	15	15	20	30	40	50	60	80	100	125

MMS-63S

Rated operational current I _e [A]	10	13	17	22	26	32	40	50	63
Max. short-circuit current									
240V [kA]	100	100	100	100	100	100	100	100	100
480V [kA]	25	25	25	25	25	25	25	25	25
600V [kA]	10	10	10	10	10	10	10	10	10
Motor load									
1 Phase 115V [HP]	1/2	1/2	1	1 ½	2	2	3	3	5
230V [HP]	1 ½	2	3	3	3	5	7 ½	10	10
3 Phase 200V [HP]	2	3	3	5	7 ½	7 ½	10	15	20
230V [HP]	3	3	5	7 ½	7 ½	10	10	15	20
460V [HP]	5	7 ½	10	15	15	20	30	30	40
575V [HP]	7 ½	10	15	20	20	30	30	40	60
Max. Fuse size [A]	40	50	60	80	100	125	150	200	250
Max. Breaker size [A]	40	50	60	80	100	125	150	200	250

MMS-100S

Rated operational current I _e [A]	17	22	26	32	40	50	63	75	90	100
Max. short-circuit current										
240V [kA]	100	100	100	100	100	100	100	100	100	100
480V [kA]	25	25	25	25	25	25	25	25	25	25
600V [kA]	10	10	10	10	10	10	10	10	10	10
Motor load										
1 Phase 115V [HP]	1	1 ½	2	2	3	3	5	5	7 ½	10
230V [HP]	3	3	3	5	7 ½	10	10	15	20	20
3 Phase 200V [HP]	3	5	7 ½	7 ½	10	15	20	20	25	30
230V [HP]	5	7 ½	7 ½	10	10	15	20	25	30	30
460V [HP]	10	15	15	20	30	30	40	50	60	75
575V [HP]	15	20	20	30	30	40	60	60	75	100
Max. Fuse size [A]	60	80	100	125	150	200	250	300	350	400
Max. Breaker size [A]	60	80	100	125	150	200	250	300	350	400

In case of 1-phase use in series as shown below

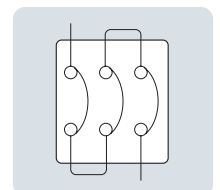

Manual motor starters



Technical information

Manual Motor Controller (UL508)

MMS-32H

Rated operational current I _e [A]	0.16	0.25	0.4	0.63	1	1.6	2.5	4	6	8	10	13	17	22	26	32
Max. short-circuit current																
240V [kA]	100	100	100	100	100	100	100	100	100	100	100	100	100	100	100	100
480V [kA]	50	50	50	50	50	50	50	50	50	50	50	50	30	30	30	30
600V [kA]	10	10	10	10	10	10	10	10	10	10	10	10	10	10	10	10
Motor load																
1 Phase 115V [HP]	-	-	-	-	-	-	-	1/8	1/4	1/3	1/2	1/2	1	1 1/2	2	2
230V [HP]	-	-	-	-	-	1/10	1/6	1/3	1/2	1	1 1/2	2	3	3	3	5
3 Phase 200V [HP]	-	-	-	-	-	-	1/2	3/4	1	2	2	3	3	5	7 1/2	7 1/2
230V [HP]	-	-	-	-	-	-	1/2	3/4	1 1/2	2	3	3	5	7 1/2	7 1/2	10
460V [HP]	-	-	-	-	-	3/4	1	2	3	5	5	7 1/2	10	15	15	20
575V [HP]	-	-	-	-	1/2	3/4	1 1/2	3	5	5	7 1/2	10	15	20	20	30
Max. Fuse size [A]	1	1	1	1	3	6	10	15	20	30	40	50	60	80	100	125
Max. Breaker size [A]	15	15	15	15	15	15	15	15	20	30	40	50	60	80	100	125

MMS-63H

Rated operational current I _e [A]	10	13	17	22	26	32	40	50	63
Max. short-circuit current									
240V [kA]	100	100	100	100	100	100	100	100	100
480V [kA]	50	50	50	50	50	50	50	50	50
600V [kA]	10	10	10	10	10	10	10	10	10
Motor load									
1 Phase 115V [HP]	1/2	1/2	1	1 1/2	2	2	3	3	5
230V [HP]	1 1/2	2	3	3	3	5	7 1/2	10	10
3 Phase 200V [HP]	2	3	3	5	7 1/2	7 1/2	10	15	20
230V [HP]	3	3	5	7 1/2	7 1/2	10	10	15	20
460V [HP]	5	7 1/2	10	15	15	20	30	30	40
575V [HP]	7 1/2	10	15	20	20	30	30	40	60
Max. Fuse size [A]	40	50	60	80	100	125	150	200	250
Max. Breaker size [A]	40	50	60	80	100	125	150	200	250

MMS-100H

Rated operational current I _e [A]	17	22	26	32	40	50	63	75	90	100
Max. short-circuit current										
240V [kA]	100	100	100	100	100	100	100	100	100	100
480V [kA]	50	50	50	50	50	50	50	50	50	50
600V [kA]	10	10	10	10	10	10	10	10	10	10
Motor load										
1 Phase 115V [HP]	1	1 1/2	2	2	3	3	5	5	7 1/2	10
230V [HP]	3	3	3	5	7 1/2	10	10	15	20	20
3 Phase 200V [HP]	3	5	7 1/2	7 1/2	10	15	20	20	25	30
230V [HP]	5	7 1/2	7 1/2	10	10	15	20	25	30	30
460V [HP]	10	15	15	20	30	30	40	50	60	75
575V [HP]	15	20	20	30	30	40	60	60	75	100
Max. Fuse size [A]	60	80	100	125	150	200	250	300	350	400
Max. Breaker size [A]	60	80	100	125	150	200	250	300	350	400

In case of 1-phase use in series as shown below

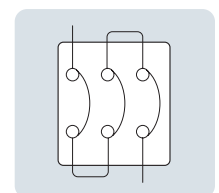

Manual motor starters



Technical information

Tripping characteristics

MMS-32AF

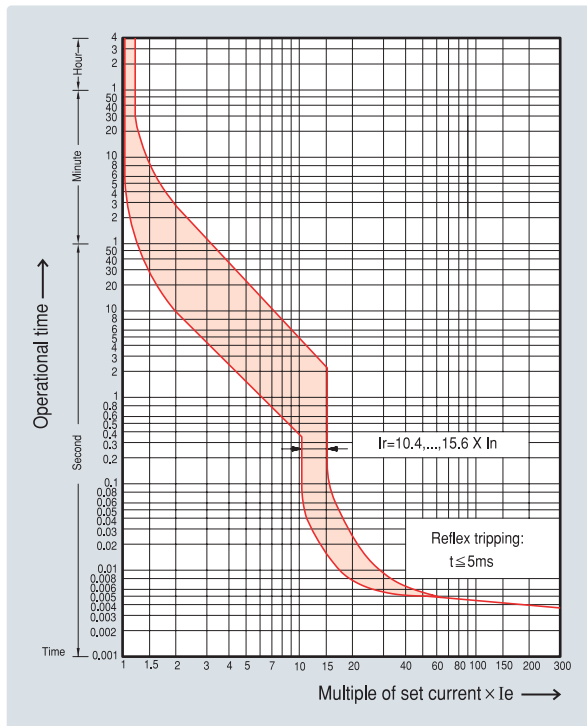

MMS-63, 100AF

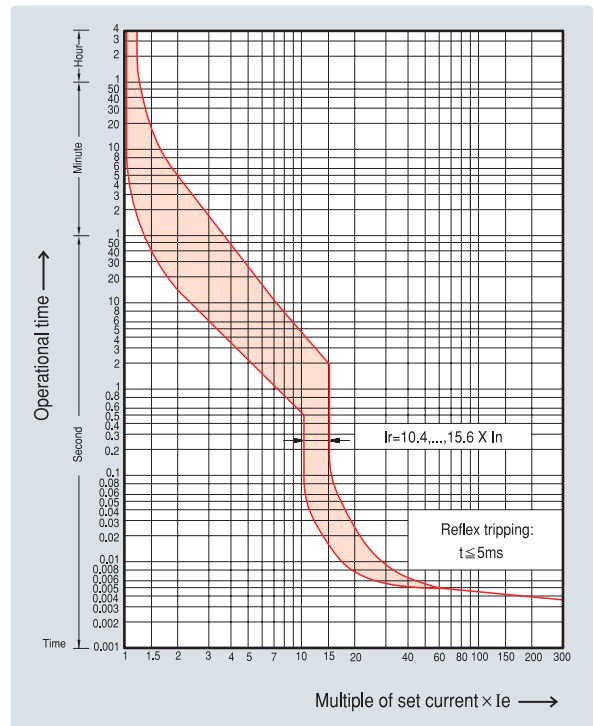

I) Thermal release trip current :

The adjustable inverse bimetal trip reliability protects motors against overloads.
The curve shows the mean operating current at an ambient temperature of 20°C starting from cold.
Careful testing and setting ensures effective motor protection even in the case of single-phasing.

II) Magnetic release trip current :

The instantaneous magnetic trip has a fixed operating current setting.
This corresponds to 13 times the maximum value of setting range,
at a lower setting it is correspondingly higher.

Current setting I_e :

The overload trip corresponds to a thermal overload relay in a motor starter conforming to IEC 947-4-1.
If a different value is prescribed (e.g. reduced I_e for cooling medium having a temperature higher than 40°C or a place of installation higher than 2000m above sea level),
the setting current is equal to the reduced rated current I_e of the motor.

Manual motor starters



Technical information

Thermal limit on short circuit

Thermal limit in kA^2s in the magnetic operating zone ($U_e=415\text{V}$)

MMS-32S/H/Hi

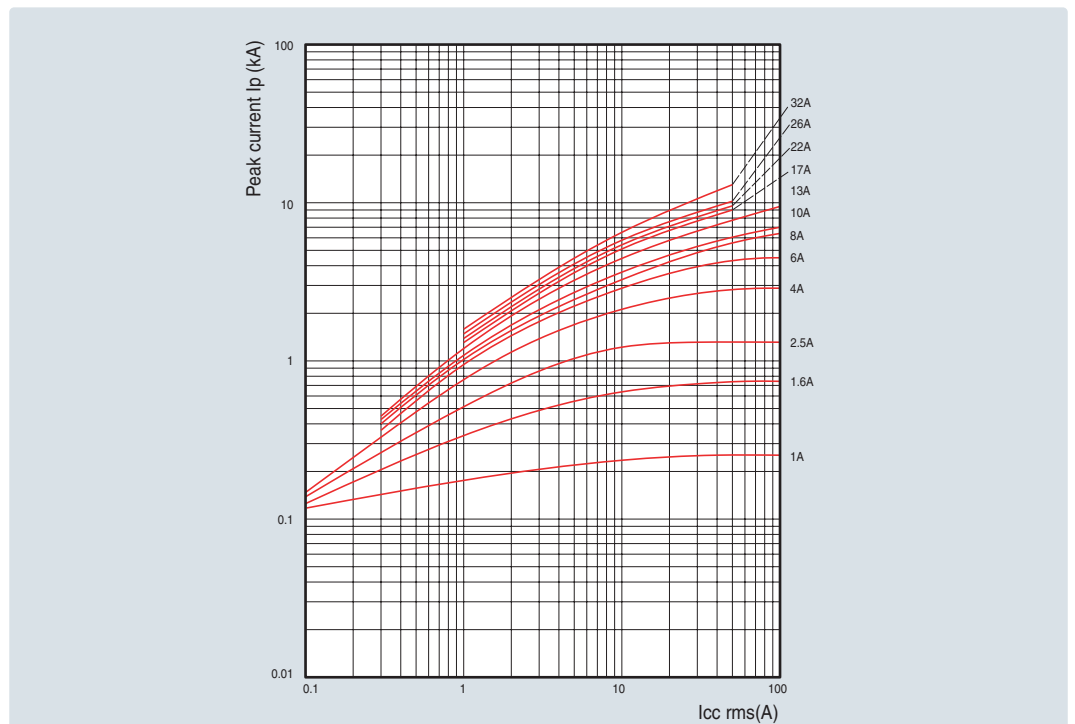
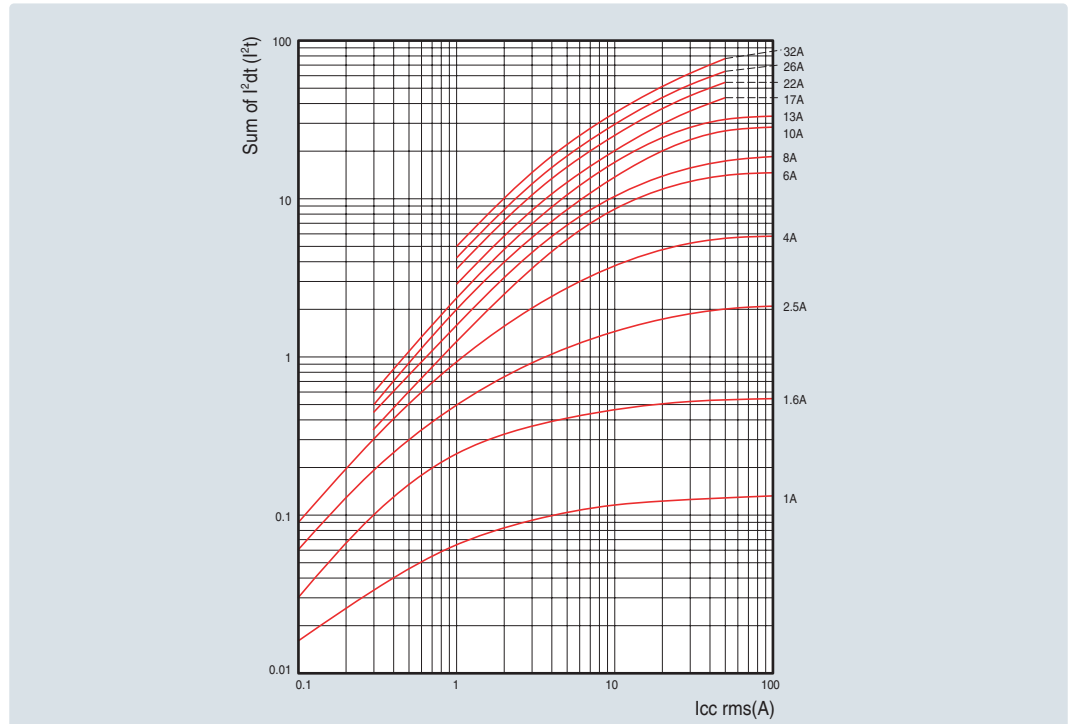

Manual motor starters



Technical information

Thermal limit on short circuit

Thermal limit in kA^2s in the magnetic operating zone ($U_e=415\text{V}$)

MMS-63S/H/Hi

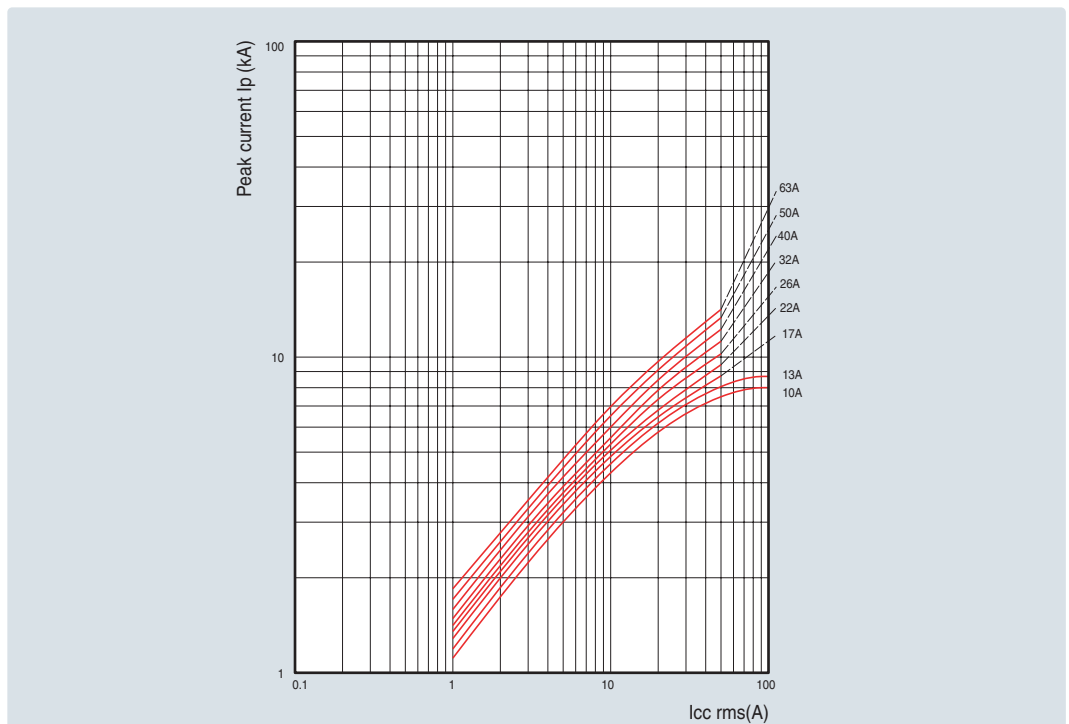
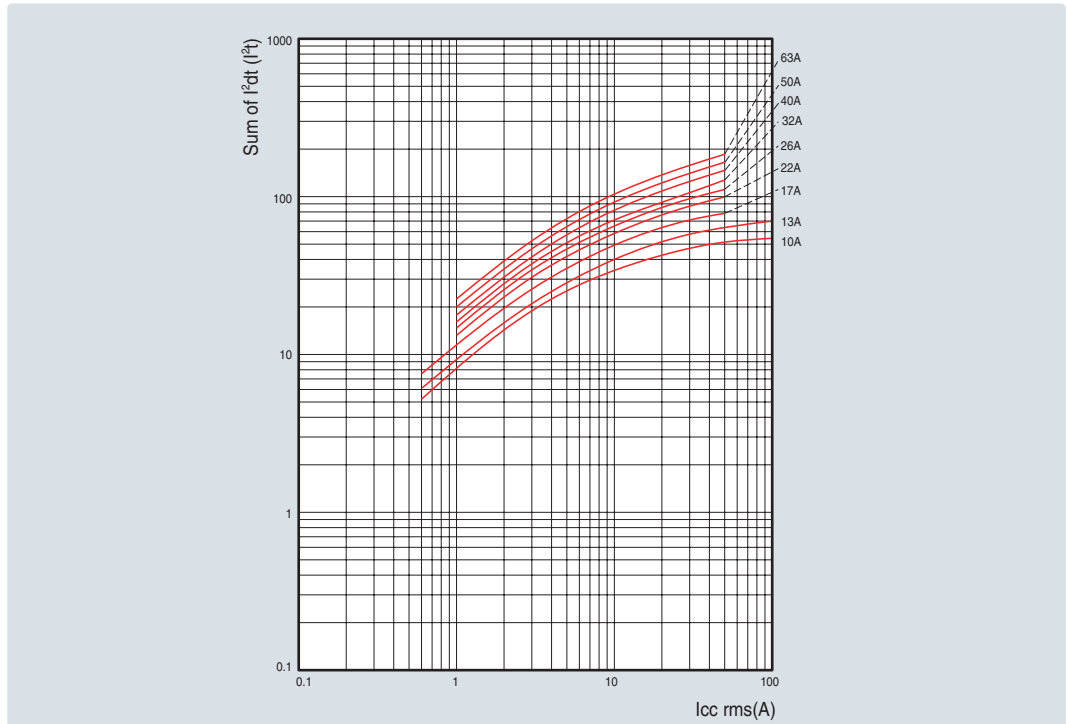

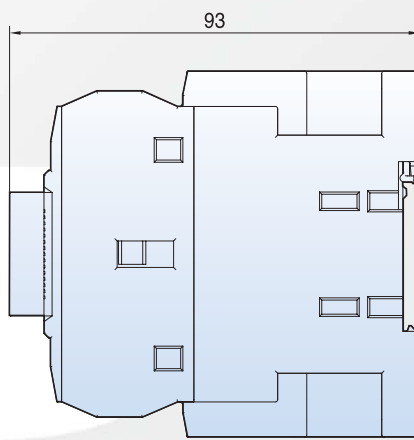
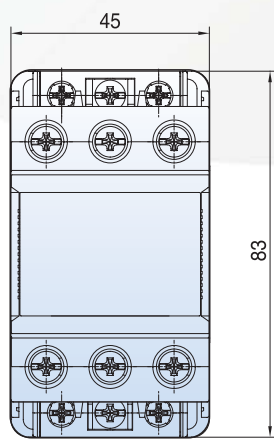

B-4. Overall dimensions

Contactors	B-4-1
Motor starters (Screw type)	B-4-4
Motor starters (Lug type)	B-4-5
Reversing contactors and starters	B-4-6
Manual motor starters	B-4-9
Combination Manual motor starters and contactors	B-4-13
Overload relays (Screw type)	B-4-15
Overload relays (Lug type)	B-4-16
Separate mounting units for overload relays (Screw type)	B-4-17
Separate mounting units for overload relays (Lug type)	B-4-18
Circuit diagram	B-4-19

Overall dimensions

Susol

Contactors

[mm]

MC-9~32 AC

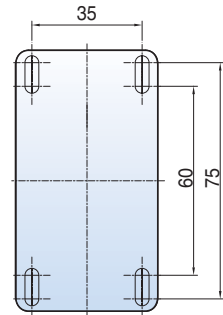
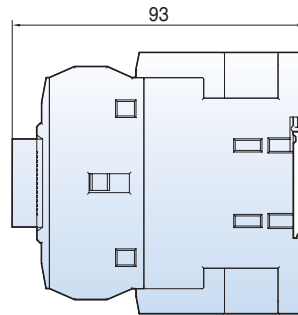
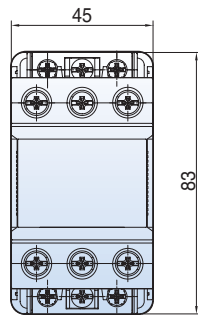

0.442kg

MC-9~32 DC

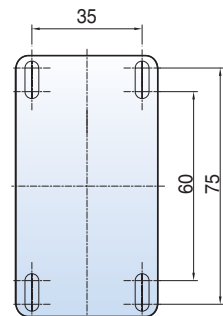
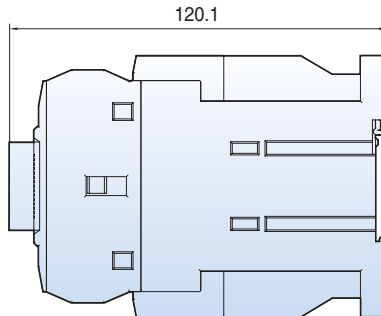
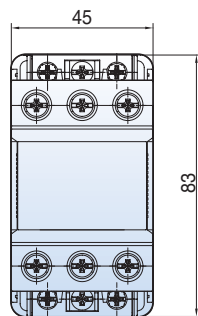

0.628kg

MC-9~32 AC

2a2b

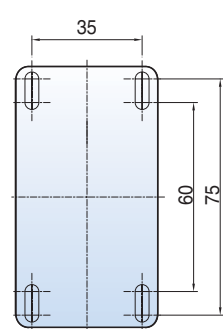
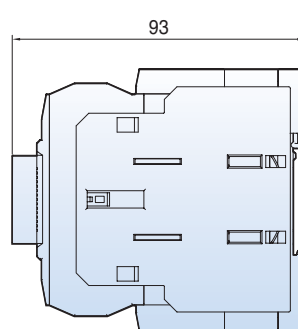
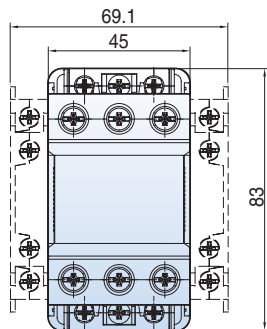

0.549kg

MC-9~32 DC

2a2b

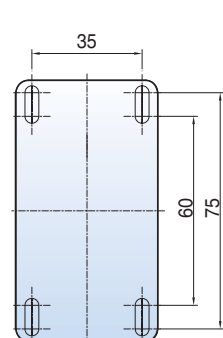
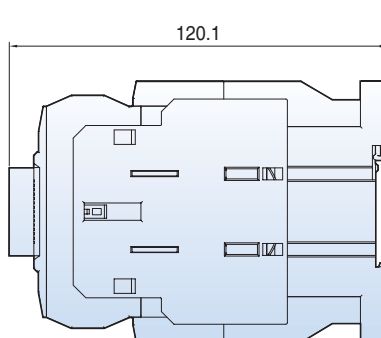
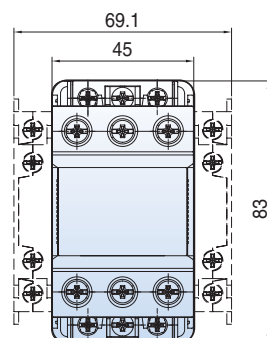

0.765kg

Overall dimensions

Susol

Contactors

[mm]

MC-35~63 AC

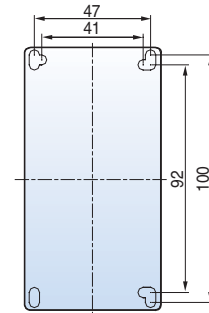
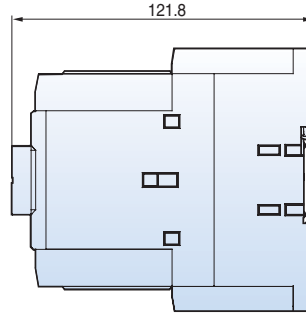
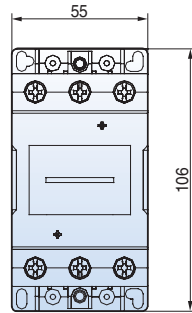

0.940kg

MC-35~63 DC

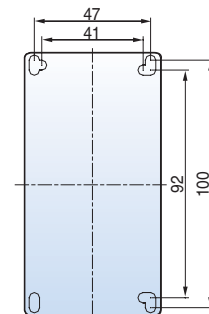
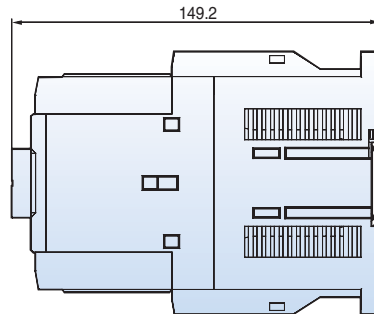
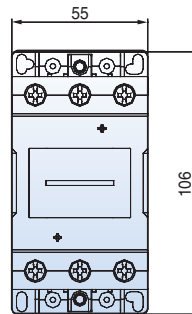

1.196kg

**MC-35~63 AC
2a2b**

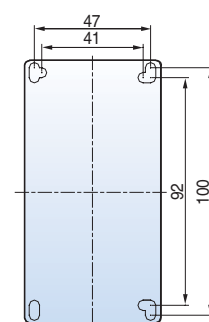
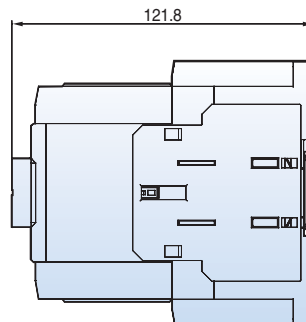
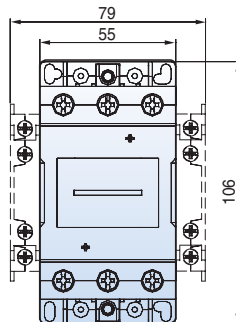

1.045kg

**MC-35~63 DC
2a2b**

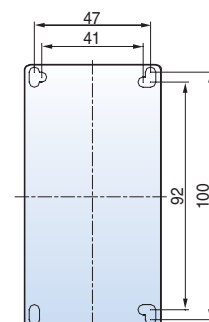
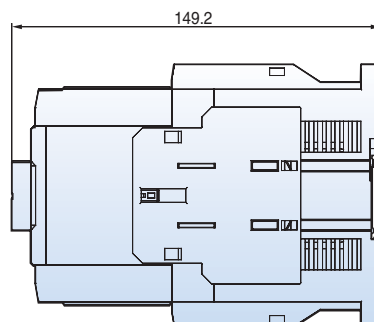
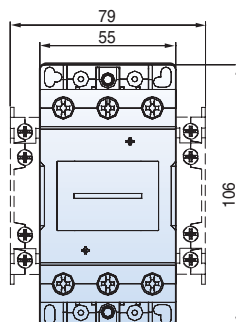

1.301kg

Overall dimensions

Susol

Contactors

[mm]

MC-65~95 AC

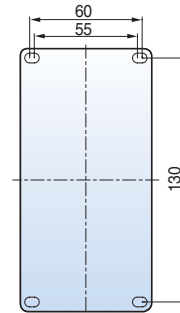
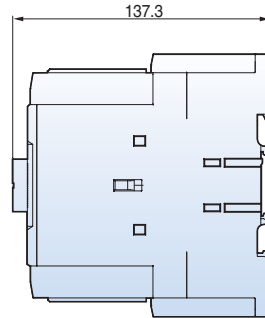
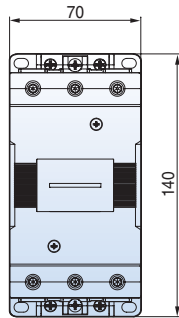

1.820kg

MC-65~95 DC

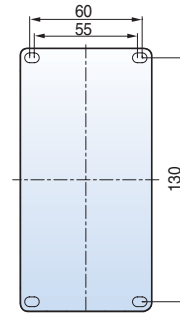
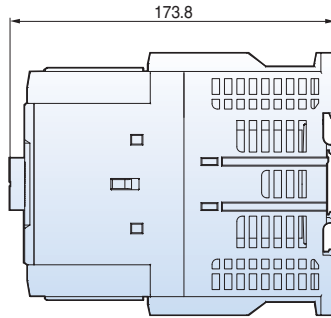
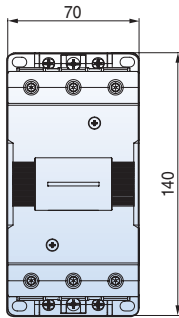

2.700kg

MC-65~95 AC

2a2b

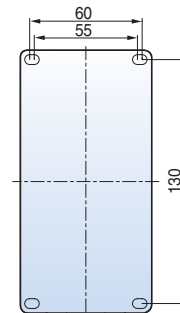
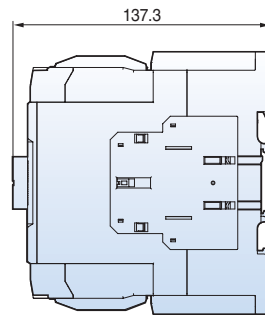
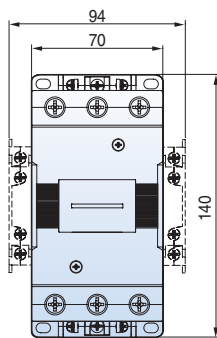

1.925kg

MC-65~95 DC

2a2b

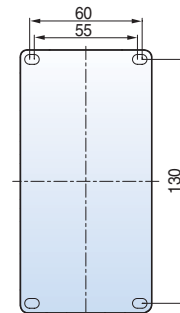
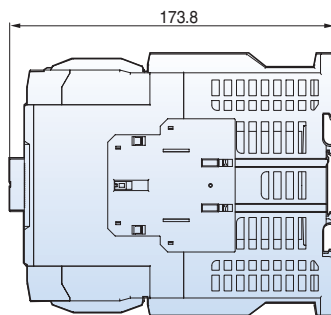
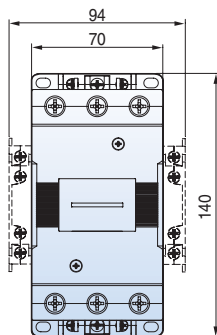

2.805kg

Overall dimensions

Susol

Motor starters (Screw type)

[mm]

- MS-9
- MS-12
- MS-18
- MS-25
- MS-32

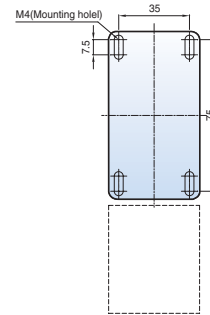
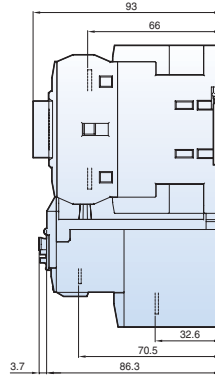
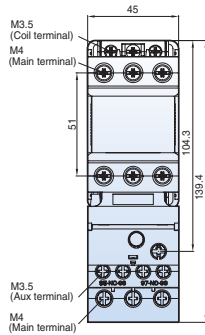

0.61kg

- MS-35
- MS-40
- MS-50
- MS-63

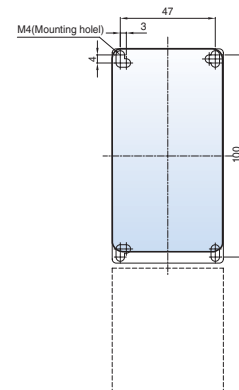
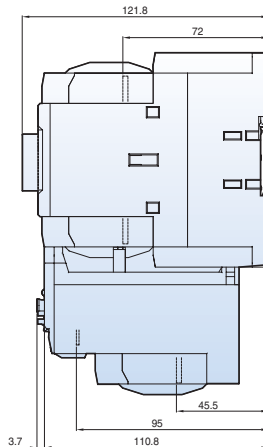
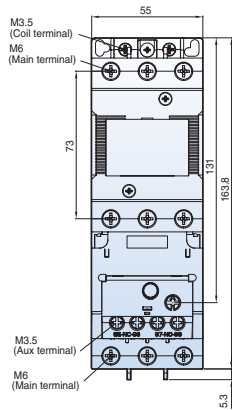

1.14kg

- MS-65
- MS-75
- MS-85
- MS-95

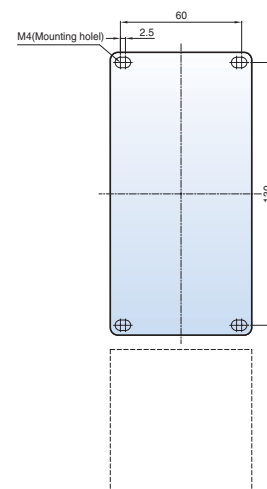
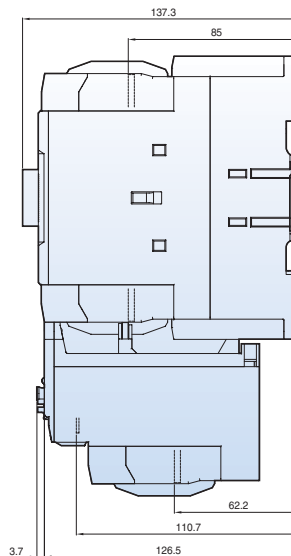
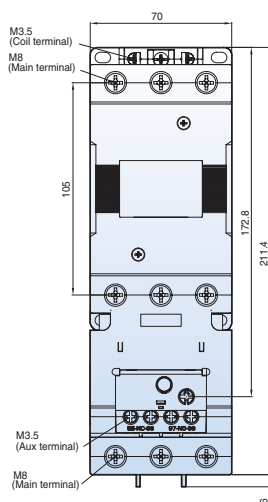

2.19kg

Overall dimensions

Susol

Motor starters (Lug type)

- MS-35
- MS-40
- MS-50
- MS-63

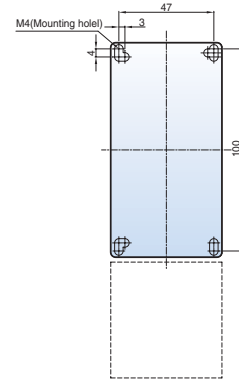
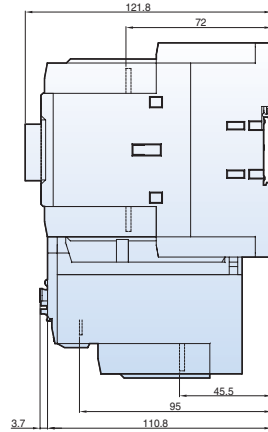
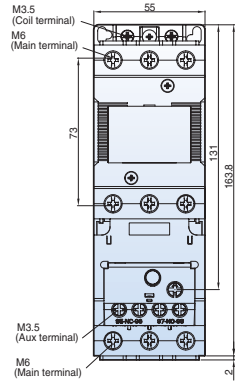

[mm]

1.14kg

- MS-65
- MS-75
- MS-85
- MS-95

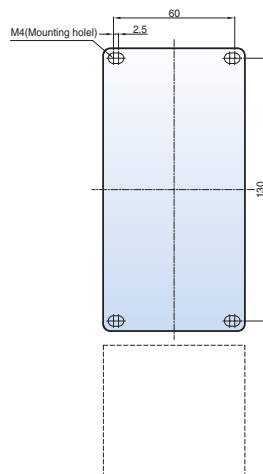
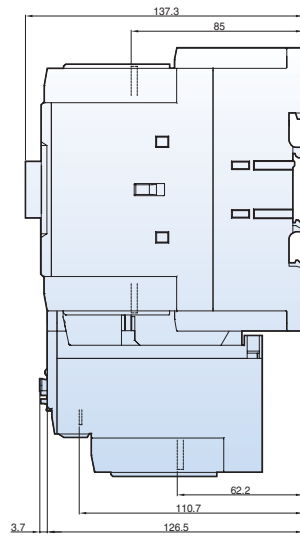
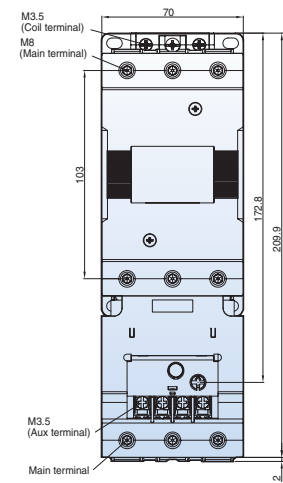

2.19kg

Overall dimensions

Susol

Reversing contactors and starters

MC-9R-32R AC

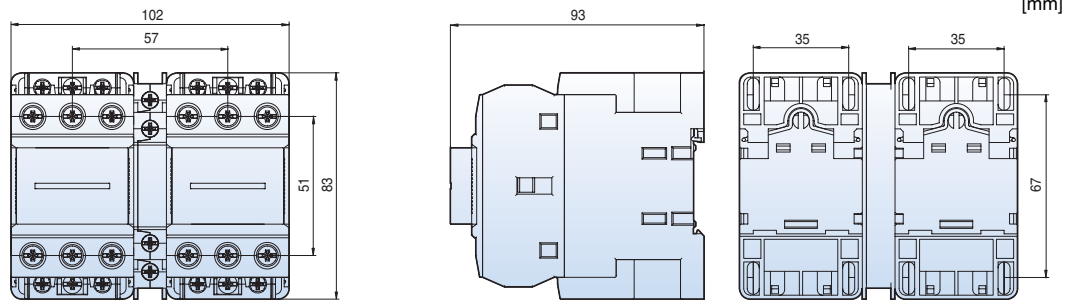

MC-9R-32R DC

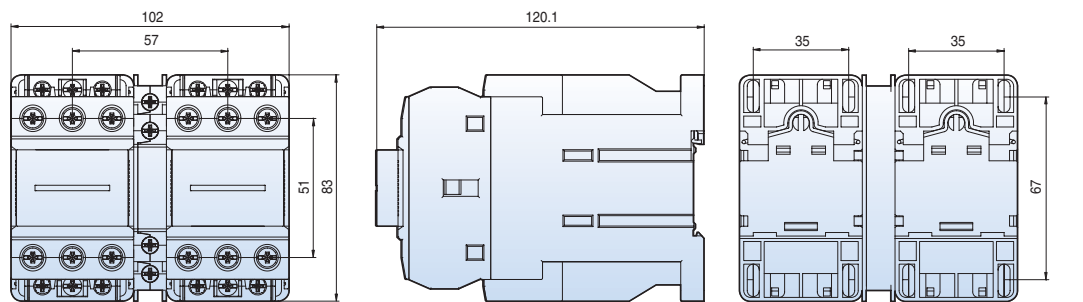

MS-9R-32R AC

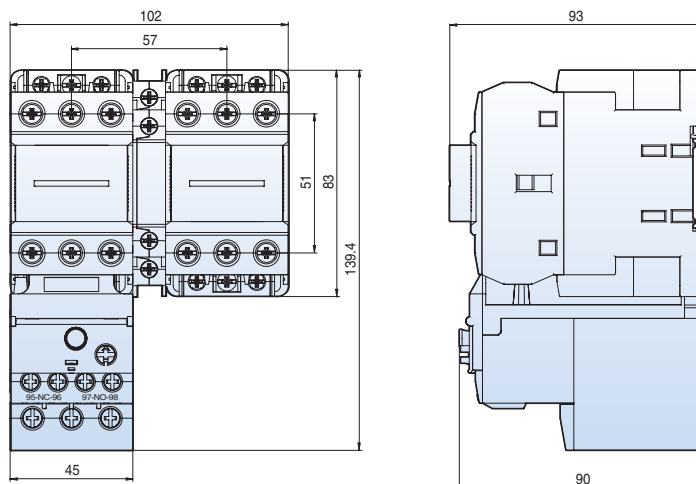

Overall dimensions

Susol

Reversing contactors and starters

MC-35R~65R AC

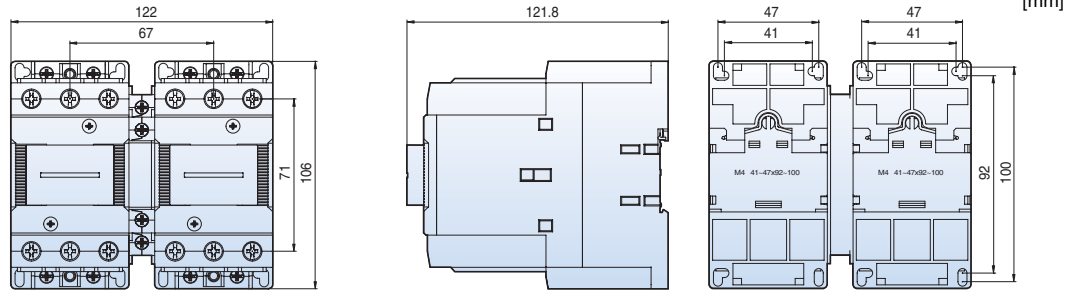

1.73kg

MC-35R~65R DC

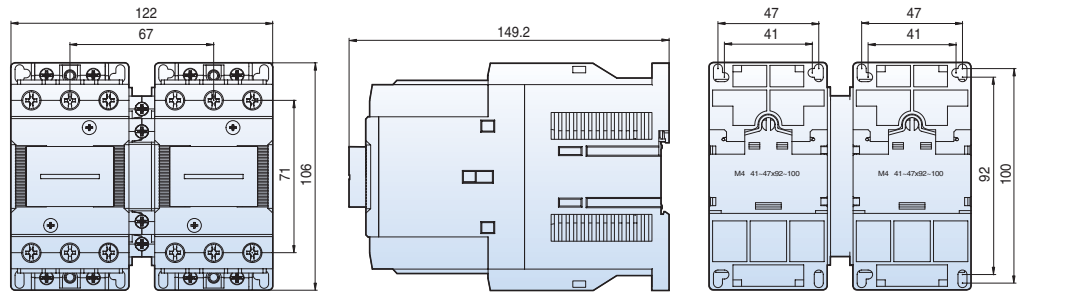

2.27kg

MS-35R~65R AC

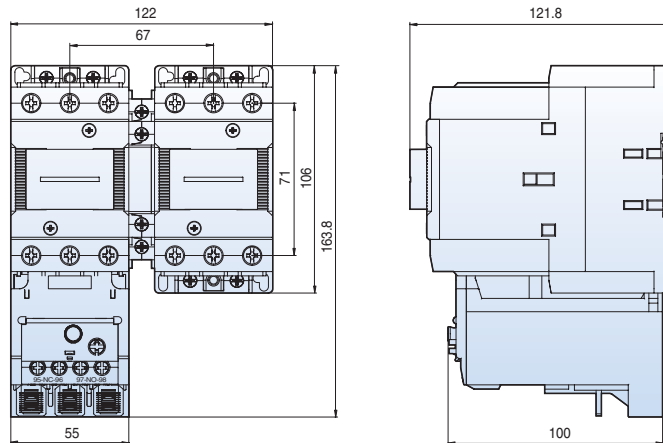

Overall dimensions

Susol

Reversing contactors and starters

MC-65R~95R AC

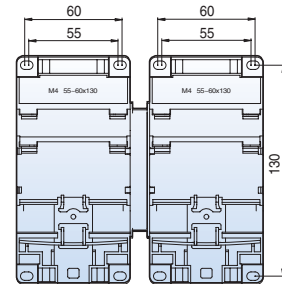
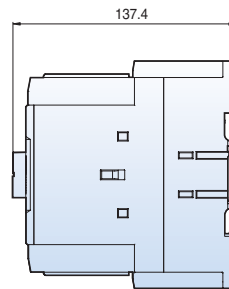
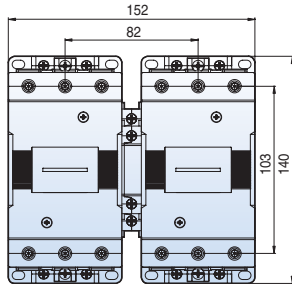

[mm]

3.25kg

MC-65R~95R DC

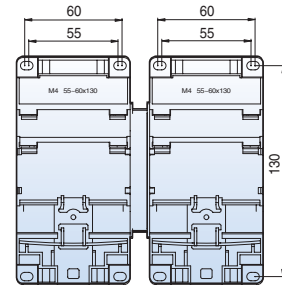
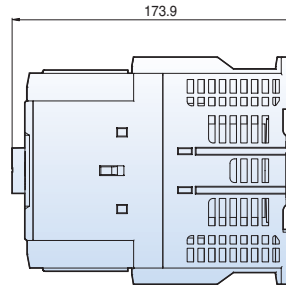
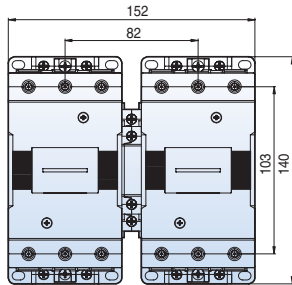

5.27kg

MS-65R~95R AC

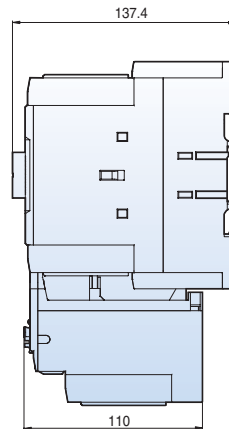
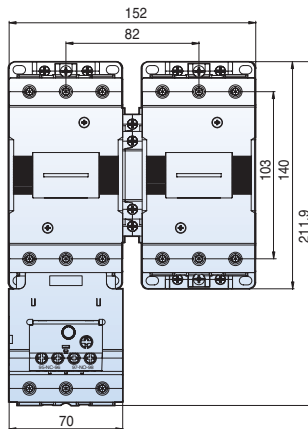

Overall dimensions



Manual motor starters

[mm]

MMS-32S

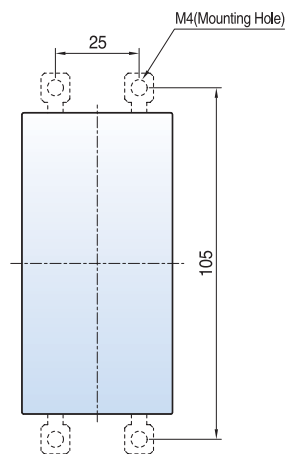
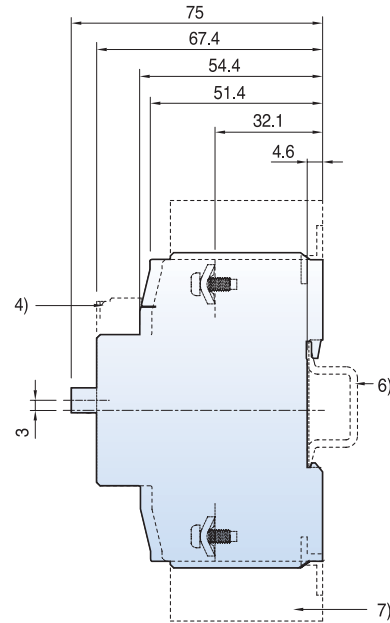
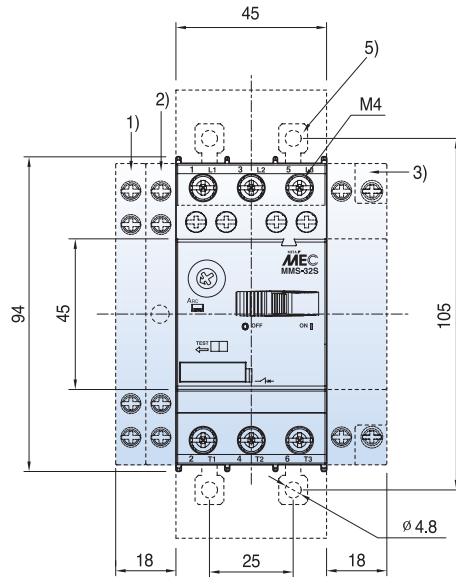

- 1) Side auxiliary switch
- 2) Side magnetic trip alarm switch
- 3) Side shunt release or Side undervoltage release
- 4) Front auxiliary switch
- 5) Push-in Lugs for screw mounting
- 6) 35mm standard mounting rail acc. to EN 50 022
- 7) Arcing space

Height of arcing spaces (Clearance from earthed parts)

Ue[V]	240	415	460	525	690
[mm]	20	20	20	20	20

Overall dimensions



Manual motor starters

[mm]

- MMS-32H
- MMS-32HI

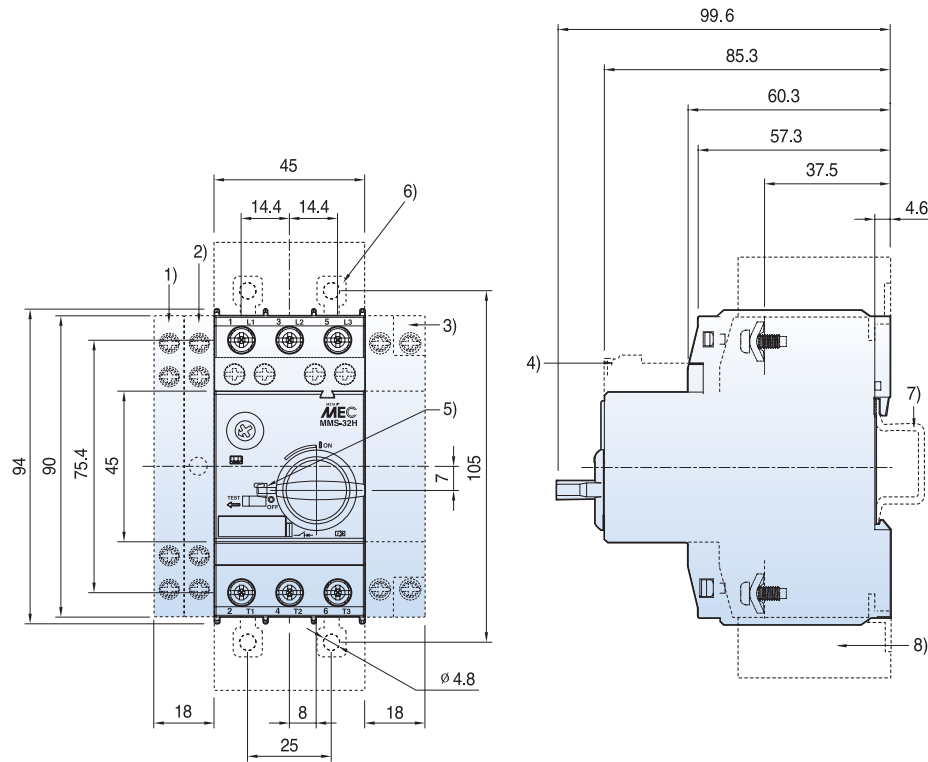

- 1) Side auxiliary switch
- 2) Side magnetic trip alarm switch
- 3) Side shunt release or Side undervoltage release
- 4) Front auxiliary switch
- 5) Handle lock in OFF position ($\varnothing 5\text{mm}$)
- 6) Push-in Lugs for screw mounting
- 7) 35mm standard mounting rail acc. to EN 50 022
- 8) Arcing space

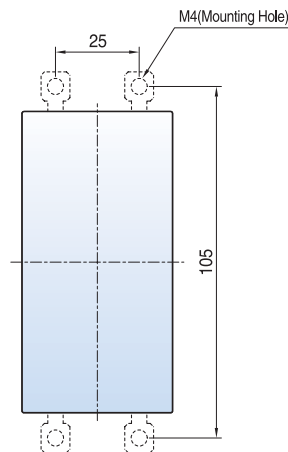

Height of arcing spaces (Clearance from earthed parts)

U _e [V]	240	415	460	525	690
[mm]	30	30	30	30	50

Overall dimensions



Manual motor starters

[mm]

- MMS-63S
- MMS-63H
- MMS-63HI

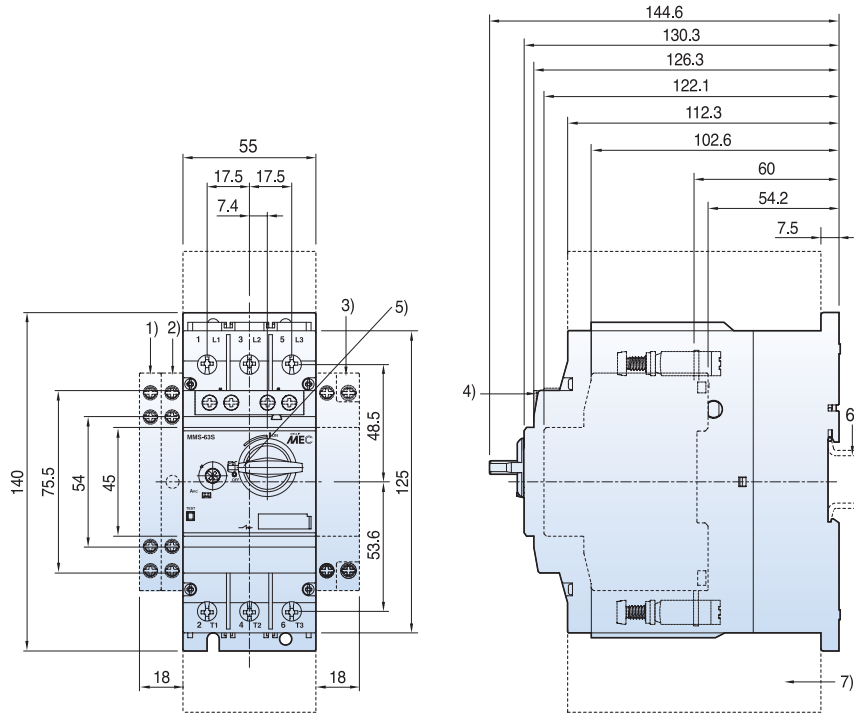

- 1) Side auxiliary switch
- 2) Side magnetic trip alarm switch
- 3) Side shunt release or Side undervoltage release
- 4) Front auxiliary switch
- 5) Handle lock in OFF position (∅ 5mm)
- 6) 35mm standard mounting rail acc. to EN 50 022
- 7) Arcing space

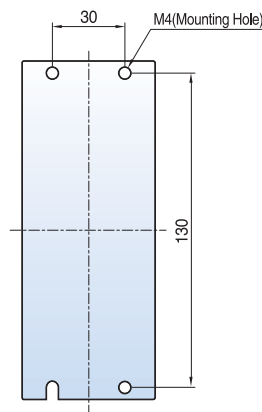

Height of arcing spaces (Clearance from earthed parts)

Ue[V]	240	415	460	525	690
[mm]	50	50	50	50	50

Overall dimensions



Manual motor starters

[mm]

- MMS-100S**
- MMS-100H**
- MMS-100HI**

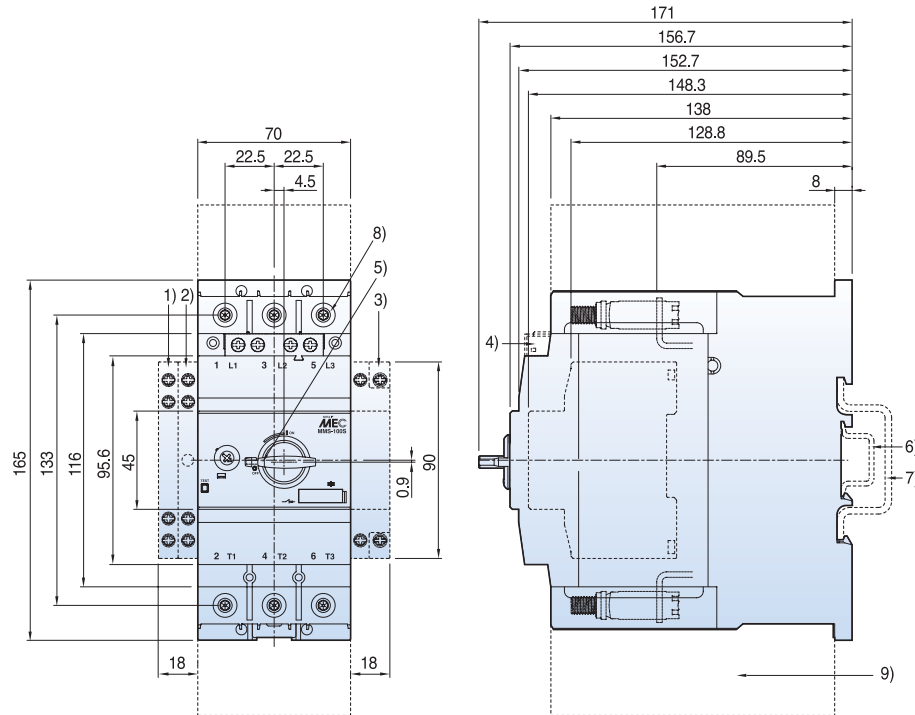

- 1) Side auxiliary switch
- 2) Side magnetic trip alarm switch
- 3) Side shunt release or Side undervoltage release
- 4) Front auxiliary switch
- 5) Handle lock in OFF position (∅ 5mm)
- 6) 35mm standard mounting rail acc. to EN 50 022
- 7) 75mm standard mounting rail acc. to EN 50 023
- 8) 4mm hexagon socket screw
- 9) Arcing space

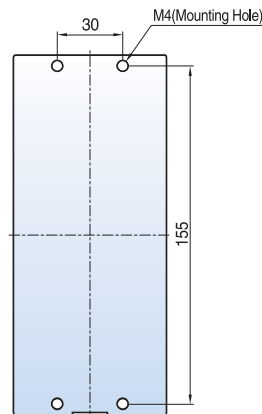

Height of arcing spaces (Clearance from earthed parts)

Ue[V]	240	415	460	525	690
[mm]	50	70	70	110	150

Overall dimensions

Susol

Combination Manual motor starters and contactors

[mm]

MMS-32S
+
MC 32AF

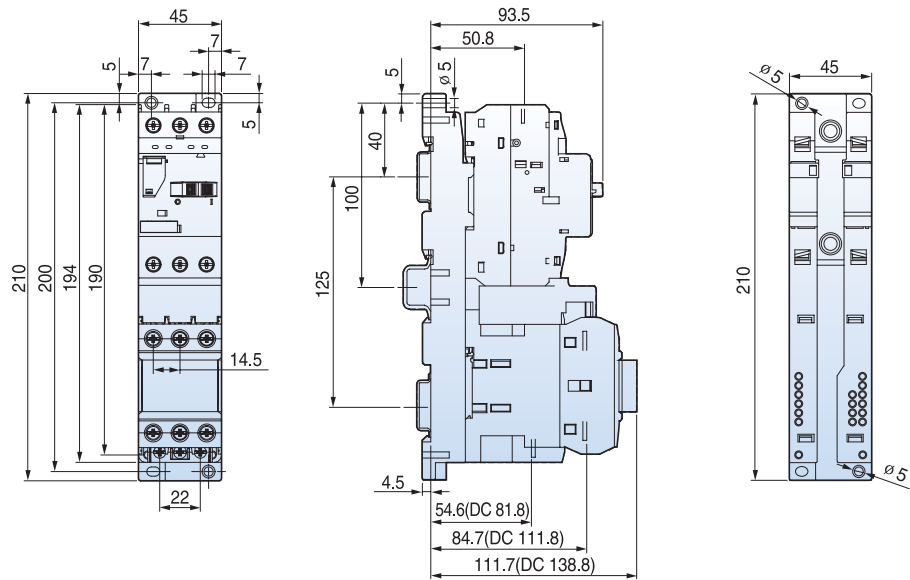

MMS-32H
+
MC 32AF

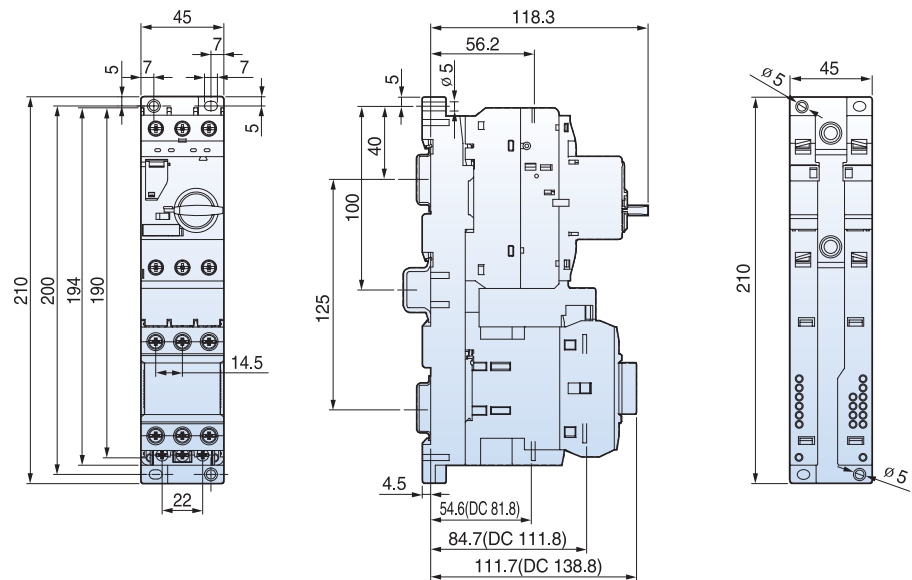

Overall dimensions

Susol

Combination Manual motor starters and contactors

[mm]

MMS-63H
+
MC 63AF

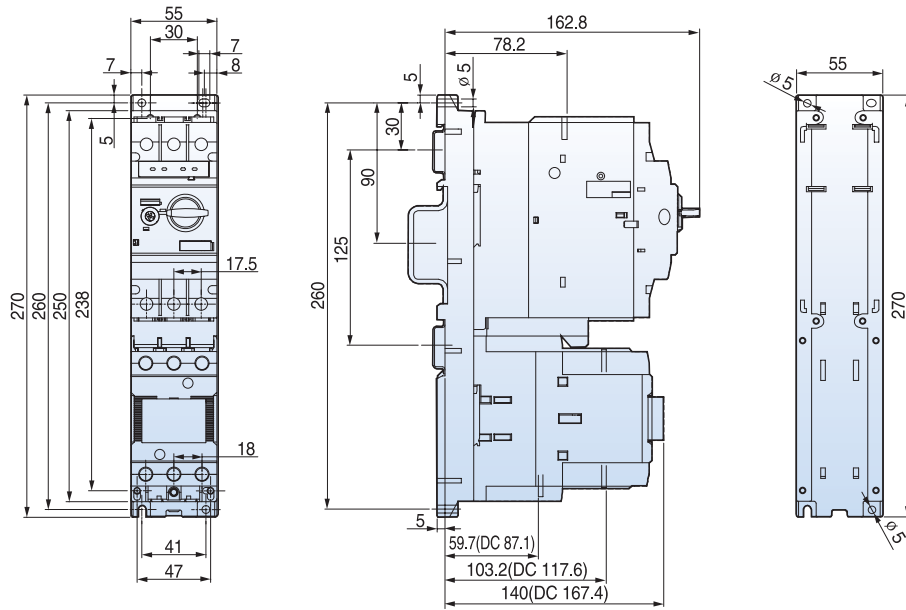

MMS-100H
+
MC 95AF

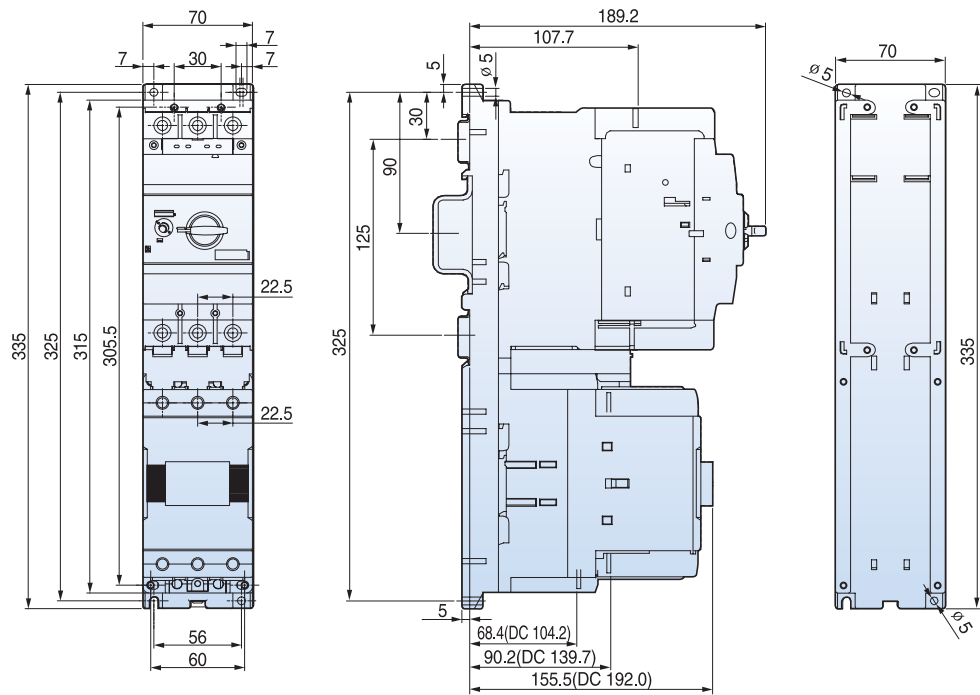

Overall dimensions

Susol

Overload relays (Screw type)

[mm]

MT-32

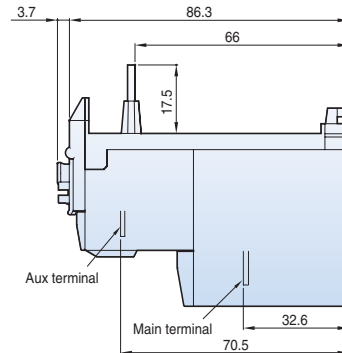
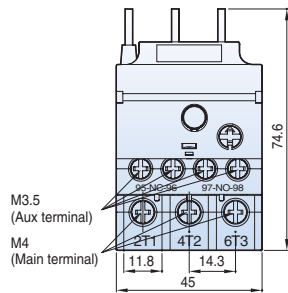

0.167kg

MT-63

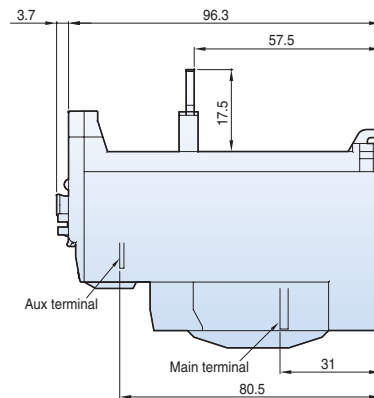
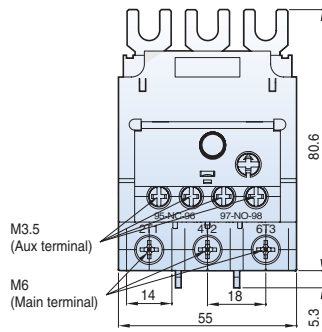

0.303kg

MT-95

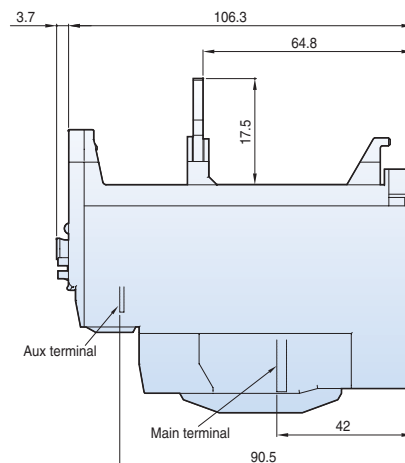
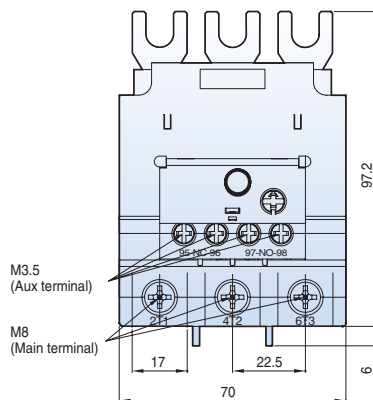

0.474kg

Overall dimensions

Susol

Overload relays (Lug type)

MT-63

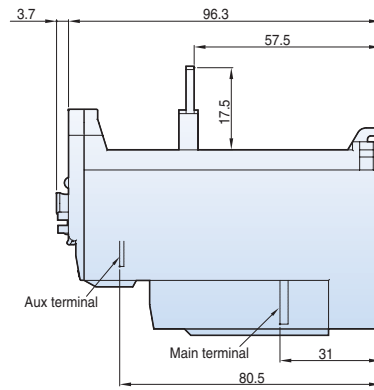
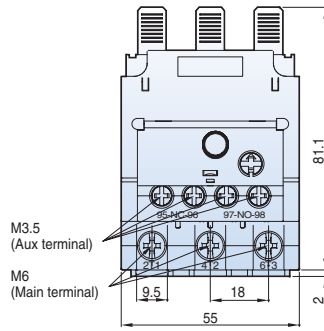

[mm]

0.326kg

MT-95

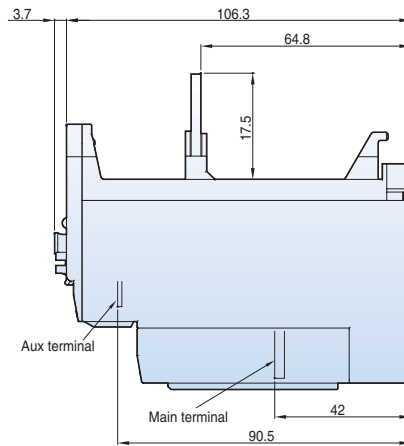
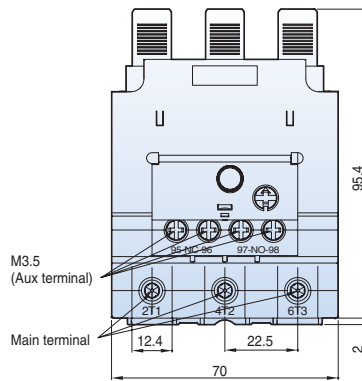

0.491kg

Overall dimensions

Susol

Separate mounting units for overload relays (Screw type)

[mm]

UZ-32

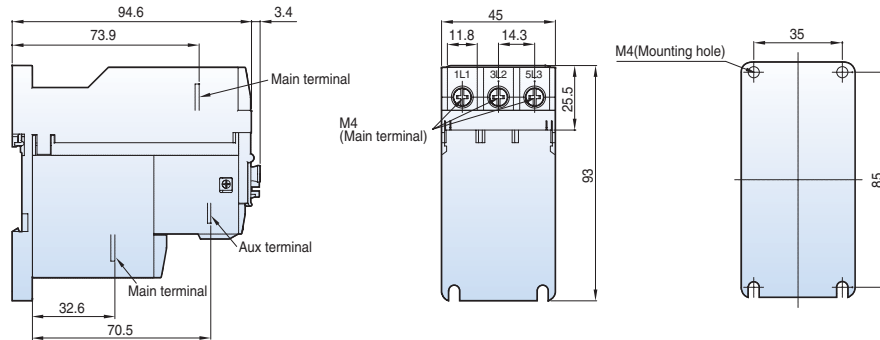

0.068kg

UZ-63/S

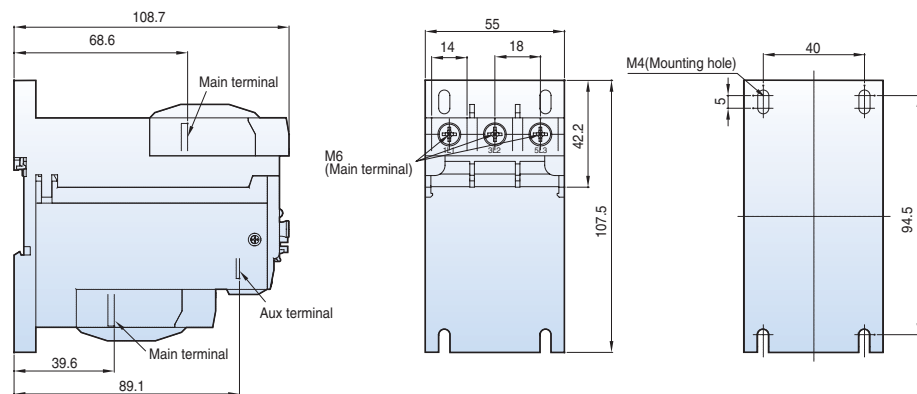

0.134kg

UZ-95/S

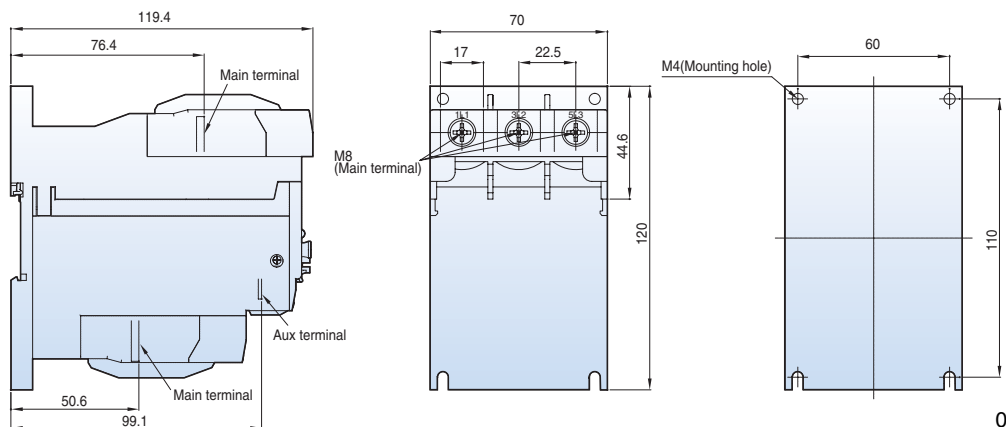

0.230kg

Overall dimensions

Susol

Separate mounting units for overload relays (Lug type)

[mm]

UZ-63/L

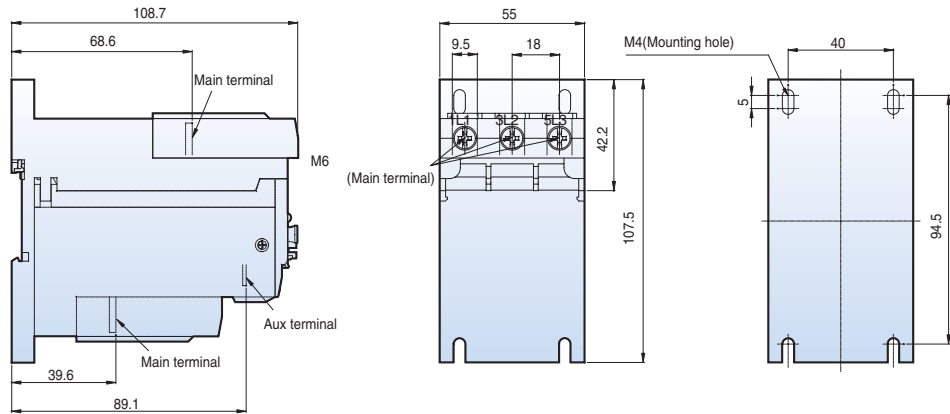

0.152kg

UZ-95/L

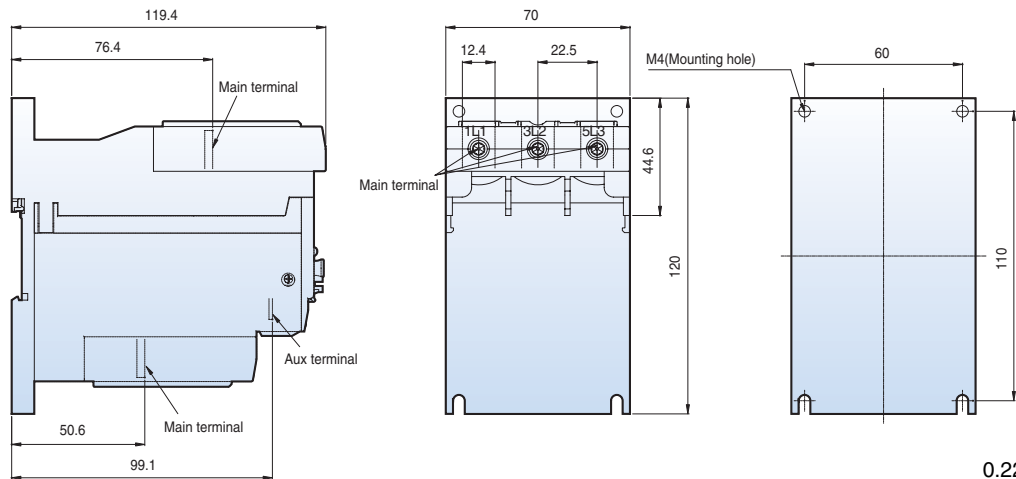

0.226kg

Overall dimensions

Susol

Circuit diagram

MC-9~95

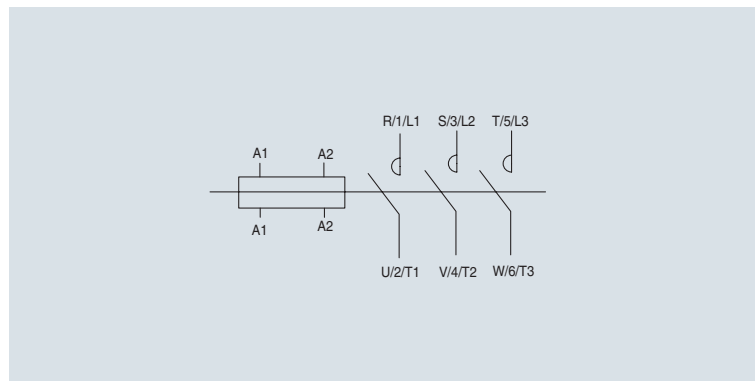

MC-9~95 2NO2NC

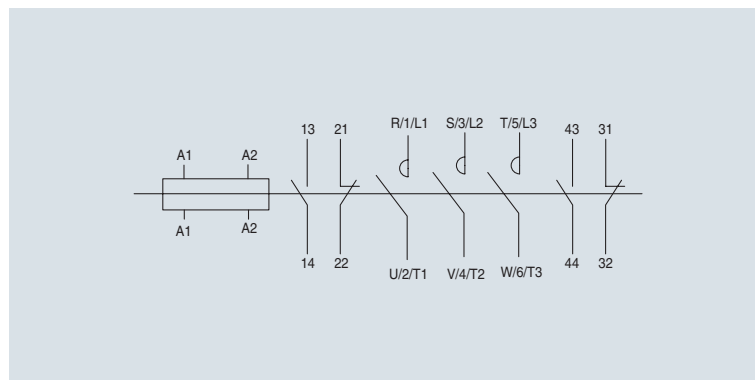

MS-9~95

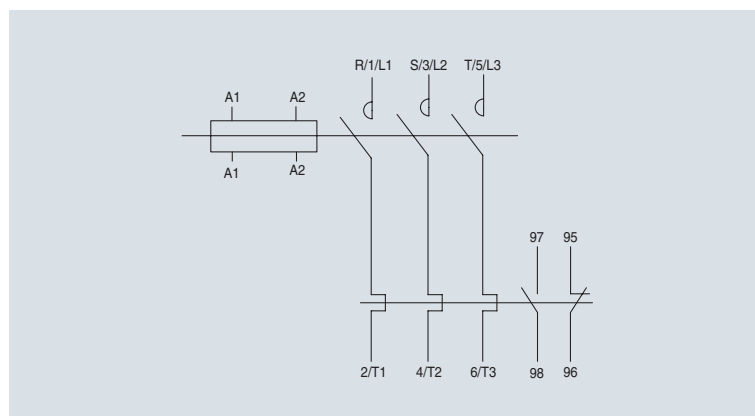

Overall dimensions

Susol

Circuit diagram

MS-9~95 2NO2NC

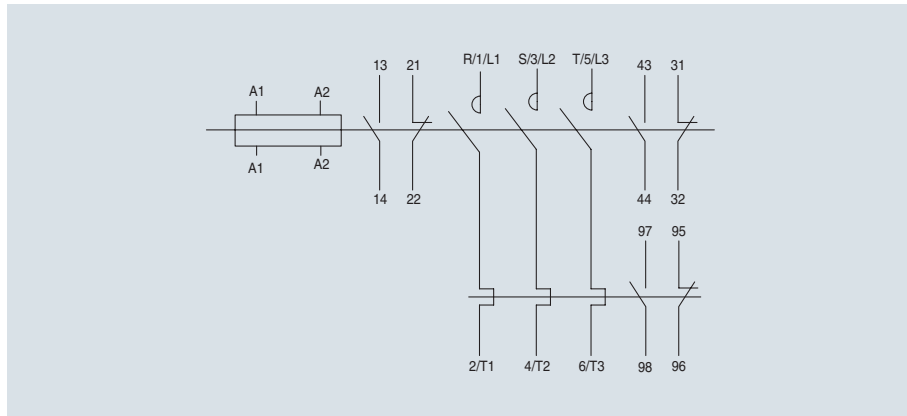

MC-9/R~95/R

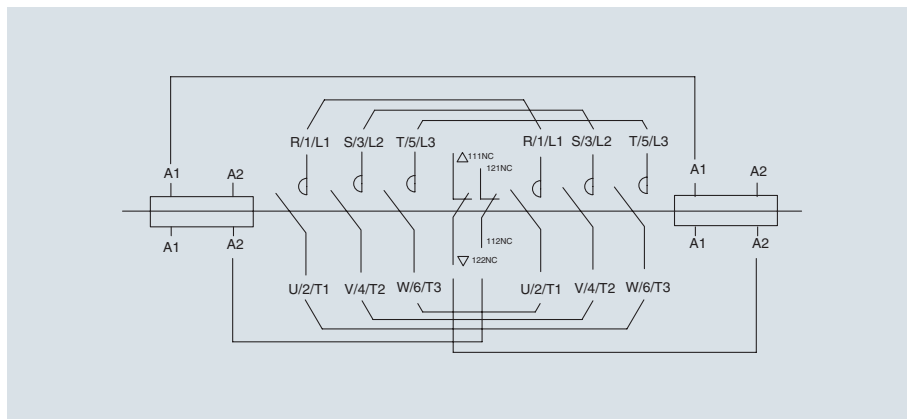

MS-9/R~95/R

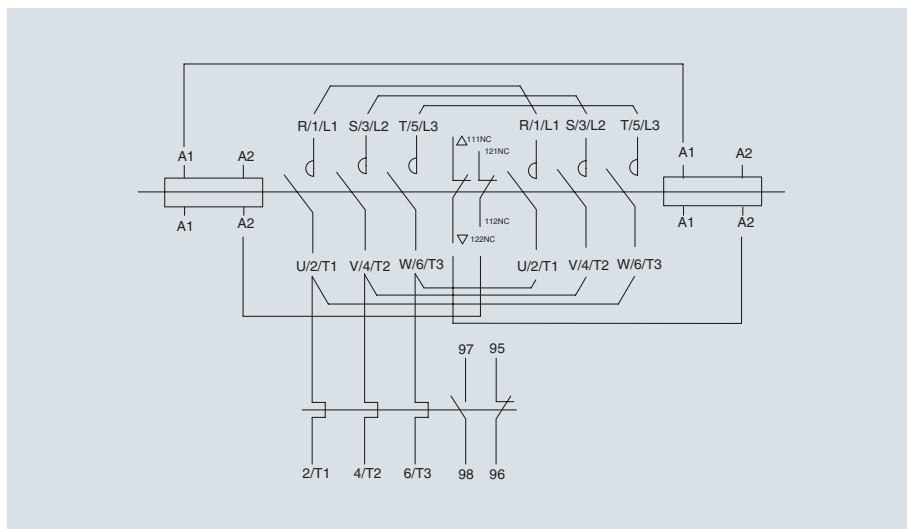



B-5. Technical information

Standards	B-5-1
specifications and certifying organizations	
Certifications and approvals	B-5-2
Utilization categories	B-5-5
Type-2 coordination	B-5-6
According to IEC60947	

Standards

specifications and certifying organizations

Test certifying organizations

Introduction

Power Testing & Technology Institute (PT & TI)



PT&TI is operating high-power laboratory, high-voltage laboratory reliability testing laboratory and calibration laboratory to aid technical development in product performance and reliability through its sound technical background and impartial operation in testing and evaluation process. PT&TI, as a KOLAS-accredited testing and calibration laboratory, would continue its contribution to promote technical development and competence of electrical industry.

Standard recognition

Type of Test Reports

- KS Korea industrial standards
- IEC International Electrotechnical Commission
- ES, PS Korea Electric Power Corporation (Provisional) Standards
- KEMC Korea Electric Manufacturers Cooperative Standards
- ANSI American National Standard Institute
- Others Other standards as dictated by the clients











Laboratory Recognition

- KOLAS accredited testing and calibration laboratory (Korea Laboratory Accreditation Scheme per ISO 17025).
Other Certification Bodies KEMA, CESI, UL etc. are in close cooperative relation.
Registered testing laboratory for electrical appliances safety certification

Technical information

Susol

Certifications and approvals











Type	Type of device	Approvals				Certificates	Certification of ship classification societies					
	Abbreviation	IEC	UL & CSA		GB	IEC	KR	LR	BV	NK	ABS	DNV
	Approved in											
	Area	Europe	U.S.A	Canada	China	Netherlands	Korea	U.K	France	Japan	U.S.A	Norway
MC	MC-9	●	●	●	○	●	○	○	○	○	▲	▲
	MC-12	●	●	●	○	●	○	○	○	○	▲	▲
	MC-18	●	●	●	○	●	○	○	○	○	▲	▲
	MC-25	●	●	●	○	●	○	○	○	○	▲	▲
	MC-32	●	●	●	○	●	○	○	○	○	▲	▲
	MC-35	●	●	●	○	●	○	○	○	○	▲	▲
	MC-40	●	●	●	○	●	○	○	○	○	▲	▲
	MC-50	●	●	●	○	●	○	○	○	○	▲	▲
	MC-65	●	●	●	○	●	○	○	○	○	▲	▲
	MC-75	●	●	●	○	●	○	○	○	○	▲	▲
	MC-85	●	●	●	○	●	○	○	○	○	▲	▲
	MC-95	●	●	●	○	●	○	○	○	○	▲	▲
MT	MT-32H	●	●	●	○	●	○	○	○	○	▲	▲
	MT-63H	●	●	●	○	●	○	○	○	○	▲	▲
	MT-95H	●	●	●	○	●	○	○	○	○	▲	▲
	MT-32L	●	●	●	○	●	○	○	○	○	▲	▲
	MT-63L	●	●	●	○	●	○	○	○	○	▲	▲
	MT-95L	●	●	●	○	●	○	○	○	○	▲	▲
	MT-32D	●	●	●	○	●	○	○	○	○	▲	▲
	MT-63D	●	●	●	○	●	○	○	○	○	▲	▲
	MT-95D	●	●	●	○	●	○	○	○	○	▲	▲

- Approved in 2005
- Approved in 2006
- ▲ Approved in 2007

Technical information

Susol

Certifications and approvals











Type	Type of device	Approvals				Certificates	Certification of ship classification societies					
	Abbreviation	IEC	UL & CSA		GB	IEC	KR	LR	BV	NK	ABS	DNV
	Approved in											
	Area	Europe	U.S.A	Canada	China	Netherlands	Korea	U.K	France	Japan	U.S.A	Norway
MS	MS-9	●	●	●	○	●	○	○	○	○	▲	▲
	MS-12	●	●	●	○	●	○	○	○	○	▲	▲
	MS-18	●	●	●	○	●	○	○	○	○	▲	▲
	MS-25	●	●	●	○	●	○	○	○	○	▲	▲
	MS-32	●	●	●	○	●	○	○	○	○	▲	▲
	MS-35	●	●	●	○	●	○	○	○	○	▲	▲
	MS-40	●	●	●	○	●	○	○	○	○	▲	▲
	MS-50	●	●	●	○	●	○	○	○	○	▲	▲
	MS-65	●	●	●	○	●	○	○	○	○	▲	▲
	MS-75	●	●	●	○	●	○	○	○	○	▲	▲
	MS-85	●	●	●	○	●	○	○	○	○	▲	▲
	MS-95	●	●	●	○	●	○	○	○	○	▲	▲
Reversing - MC	MC-9R	●	●	●	○	●	○	○	○	○	▲	▲
	MC-12R	●	●	●	○	●	○	○	○	○	▲	▲
	MC-18R	●	●	●	○	●	○	○	○	○	▲	▲
	MC-25R	●	●	●	○	●	○	○	○	○	▲	▲
	MC-32R	●	●	●	○	●	○	○	○	○	▲	▲
	MC-35R	●	●	●	○	●	○	○	○	○	▲	▲
	MC-40R	●	●	●	○	●	○	○	○	○	▲	▲
	MC-50R	●	●	●	○	●	○	○	○	○	▲	▲
	MC-63R											
	MC-65R	●	●	●	○	●	○	○	○	○	▲	▲
	MC-75R											
	MC-85R											
	MC-95R											

- Approved in 2005
- Approved in 2006
- ▲ Approved in 2007

Technical information

Susol

Certifications and approvals

Type	Type of device	Approvals				Certificates	Certification of ship classification societies					
	Abbreviation	IEC	UL & CSA		GB	IEC	KR	LR	BV	NK	ABS	DNV
	Approved in											
	Area	Europe	U.S.A	Canada	China	Netherlands	Korea	U.K	France	Japan	U.S.A	Norway
Reversing - MS	MS-9R	●	●	●	○	●	○	○	○	○	▲	▲
	MS-12R	●	●	●	○	●	○	○	○	○	▲	▲
	MS-18R	●	●	●	○	●	○	○	○	○	▲	▲
	MS-25R	●	●	●	○	●	○	○	○	○	▲	▲
	MS-32R	●	●	●	○	●	○	○	○	○	▲	▲
	MS-35R	●	●	●	○	●	○	○	○	○	▲	▲
	MS-40R	●	●	●	○	●	○	○	○	○	▲	▲
	MS-50R	●	●	●	○	●	○	○	○	○	▲	▲
	MS-63R	●	●	●	○	●	○	○	○	○	▲	▲
	MS-65R	●	●	●	○	●	○	○	○	○	▲	▲
	MS-75R	●	●	●	○	●	○	○	○	○	▲	▲
	MS-85R	●	●	●	○	●	○	○	○	○	▲	▲
	MS-95R	●	●	●	○	●	○	○	○	○	▲	▲

- Approved in 2005
- Approved in 2006
- ▲ Approved in 2007

Utilization categories

Standards:

IEC publications 941-1, 947-4-1 and 947-5-1 should be referred to on an international level with respect to contactors, contactor relays and thermal overload relays.

Utilization Categories:

A contactor's duty is characterized by the utilization category together with the rated operational voltage and current indicated.

Utilization Categories for Contactors According to IEC 947-4-1:

Alternating current:	AC-1	Non-inductive or slightly inductive loads, resistance furnaces.
	AC-2	Slip-ring motors: starting, switching off.
	AC-3	Cage motors: starting, switching off running motors.
	AC-4	Cage motors: starting, plugging, inching.
	AC-5a	Discharge lamp switching.
	AC-5b	Incandescent lamp switching.
	AC-6a	Transformer switching.
	AC-6b	Capacitor bank switching.
	AC-7a	Slightly inductive loads for domestic devices and similar applications.
	AC-7b	Motors for domestic applications.
Direct current:	DC-1	Non inductive or slightly inductive loads, resistance Furnaces.
	DC-3	Shunt motors: starting, plugging, inching, dynamic breaking of d.c. motors.
	DC-5	Series motors: starting, plugging, inching, dynamic breaking of d.c. motors.
	DC-6	Incandescent lamp switching.

Utilization Categories for Contactor Relays According to IEC 947-5-1:

Alternating current:	AC-12	Control of resistive loads and static loads with opto-coupler isolation.
	AC-13	Control of static loads with transformer isolation.
	AC-14	Control of weak electromagnetic load ($\leq 72VA$).
	AD-15	Control of electromagnetic loads ($< 72VA$).
Direct current:	DC-12	Control of resistive loads and static loads with opto-coupler isolation.
	DC-13	Control of d.c. electromagnets.
	DC-14	Control of electromagnets having economy resistors.

Technical information

Susol

Type-2 coordination

According to IEC60947

Performance: Ue=200/240V			
MCCB	N	H	L
TD100	85kA	100kA	200kA
TS100	100kA	120kA	200kA

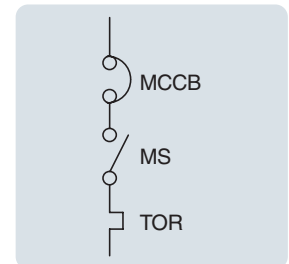

Motor		MCCB		Contactor	Thermal overload relay	
kW	A	Type	Rating I _r (A)	Type	Type	Setting range(A)
0.37	1.8	TD100	16	MC-9	MT-32	1.6-2.5
0.55	2.75	TD100	16	MC-32	MT-32	2.5-4
0.75	3.5	TD100	16	MC-32	MT-32	2.5-4
1.1	4.4	TD100	16	MC-40	MT-63	4-6
1.5	6.1	TD100	16	MC-40	MT-63	5-8
2.2	8.7	TD100	16	MC-40	MT-63	9-13
3	11.5	TD100	16	MC-40	MT-63	9-13
3.7	13.5	TD100	16	MC-40	MT-63	12-18
4	14.5	TD100	16	MC-40	MT-63	12-18
5.5	20	TD100	20	MC-40	MT-63	16-22
7.5	27	TD100	32	MC-40	MT-63	24-36
9	32	TD100	32	MC-85	MT-95	28-40
10	35	TD100	40	MC-85	MT-95	28-40
11	39	TD100	40	MC-85	MT-95	34-50
15	52	TD100	63	MC-85	MT-95	45-65
18.5	64	TD100 TS100	80	MC-85	MT-95	54-75
22	75	TD100 TS100	80	MC-85	MT-95	63-85
25	85	TD100 TS100	100	MC-85	MT-95	70-95

Type-2 coordination

According to IEC60947

Performance: Ue=380/415V			
MCCB	N	H	L
TD100	50kA	85kA	150kA
TS100	50kA	85kA	150kA

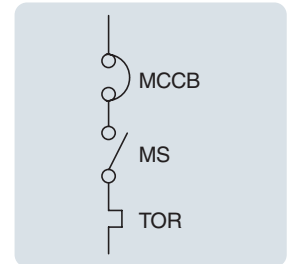

Motor		MCCB		Contactor	Thermal overload relay	
kW	A	Type	Rating Ir(A)	Type	Type	Setting range(A)
0.37	1.03	TD100	16	MC-9	MT-32	1-1.6
0.55	1.6	TD100	16	MC-9	MT-32	1-1.6
0.75	2	TD100	16	MC-9	MT-32	1.6-2.5
1.1	2.6	TD100	16	MC-32	MT-32	2.5-4
1.5	3.5	TD100	16	MC-32	MT-32	2.5-4
2.2	5	TD100	16	MC-40	MT-63	4-6
3	6.6	TD100	16	MC-40	MT-63	5-8
3.7	7.7	TD100	16	MC-40	MT-63	6-9
4	8.5	TD100	16	MC-40	MT-63	7-10
5.5	11.5	TD100	16	MC-40	MT-63	9-13
7.5	15.5	TD100	16	MC-40	MT-63	12-18
9	18.5	TD100	20	MC-40	MT-63	16-22
10	20	TD100	20	MC-40	MT-63	16-22
11	22	TD100	25	MC-40	MT-63	16-22
15	30	TD100	32	MC-85	MT-95	24-36
18.5	37	TD100 TS100	40	MC-85	MT-95	28-40
22	44	TD100 TS100	50	MC-85	MT-95	34-50
25	52	TD100 TS100	63	MC-85	MT-95	45-65
30	60	TD100 TS100	63	MC-85	MT-95	45-65
33	68	TD100 TS100	80	MC-85	MT-95	54-75
37	72	TD100 TS100	80	MC-85	MT-95	63-85
40	79	TD100 TS100	80	MC-85	MT-95	63-85
45	85	TD100 TS100	100	MC-85	MT-95	70-95

Technical information

Susol

Type-2 coordination

According to IEC60947

Performance: Ue=440V			
MCCB	N	H	L
TD100	42kA	72kA	130kA
TS100	42kA	72kA	130kA

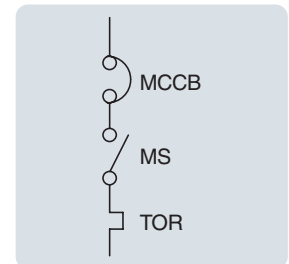

Motor		MCCB		Contactor	Thermal overload relay	
kW	A	Type	Rating I _r (A)	Type	Type	Setting range(A)
0.37	0.99	TD100	16	MC-9	MT-32	0.63-1
0.55	1.36	TD100	16	MC-9	MT-32	1-1.6
0.75	1.68	TD100	16	MC-9	MT-32	1.6-2.5
1.1	2.37	TD100	16	MC-9	MT-32	1.6-2.5
1.5	3.06	TD100	16	MC-18	MT-32	2.5-4
2.2	4.42	TD100	16	MC-25	MT-32	4-6
3	5.57	TD100	16	MC-25	MT-32	4-6
3.7	7.1	TD100	16	MC-32	MT-32	5-8
4	7.9	TD100	16	MC-32	MT-32	6-9
5.5	10.4	TD100	20	MC-32	MT-32	9-13
7.5	13.7	TD100	20	MC-32	MT-32	12-18
9	16.9	TD100	20	MC-40	MT-63	12-18
11	20.1	TD100	25	MC-40	MT-63	16-22
15	26.5	TD100	32	MC-40	MT-63	24-36
18.5	32.8	TD100 TS100	40	MC-50	MT-63	28-40
22	39	TD100 TS100	40	MC-50	MT-63	34-50
25	45.3	TD100 TS100	50	MC-50	MT-63	34-50
30	51.5	TD100 TS100	63	MC-65	MT-95	45-65
33	58	TD100 TS100	63	MC-65	MT-95	45-65
37	64	TD100 TS100	80	MC-65	MT-95	54-75
40	67	TD100 TS100	80	MC-85	MT-95	54-75
45	76	TD100 TS100	100	MC-85	MT-95	63-85

Type-2 coordination

According to IEC60947

Performance: Ue=480/500V			
MCCB	N	H	L
TD100	30kA	50kA	65kA
TS100	42kA	65kA	85kA

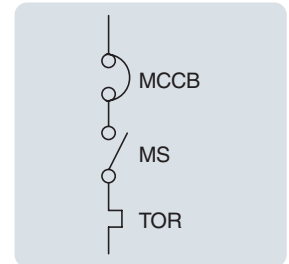

Motor		MCCB		Contactor	Thermal overload relay	
kW	A	Type	Rating Ir(A)	Type	Type	Setting range(A)
0.37	1	TD100	16	MC-9	MT-32	0.63-1
0.55	1.21	TD100	16	MC-9	MT-32	1-1.6
0.75	1.5	TD100	16	MC-9	MT-32	1-1.6
1.1	2	TD100	16	MC-9	MT-32	1.6-2.5
1.5	2.6	TD100	16	MC-32	MT-32	2.5-4
2.2	3.8	TD100	16	MC-32	MT-32	2.5-4
3	5	TD100	16	MC-40	MT-63	4-6
3.7	5.9	TD100	16	MC-40	MT-63	5-8
4	6.5	TD100	16	MC-40	MT-63	5-8
5.5	9	TD100	16	MC-40	MT-63	7-10
7.5	12	TD100	16	MC-40	MT-63	9-13
9	13.9	TD100	16	MC-40	MT-63	12-18
11	15	TD100	16	MC-85	MT-95	12-18
15	18.4	TD100	20	MC-85	MT-95	16-22
18.5	23	TD100	25	MC-85	MT-95	18-25
22	28.5	TD100	32	MC-85	MT-95	24-36
25	33	TD100 TS100	40	MC-85	MT-95	28-40
30	39.4	TD100 TS100	40	MC-85	MT-95	34-50
33	45	TD100 TS100	50	MC-85	MT-95	34-50
37	50	TD100 TS100	50	MC-85	MT-95	45-65
40	55	TD100 TS100	63	MC-85	MT-95	45-65
45	60	TD100 TS100	63	MC-85	MT-95	54-75

Technical information

Susol

Type-2 coordination

According to IEC60947

Performance: Ue=660/690V			
MCCB	N	H	L
TD100	42kA	72kA	130kA
TS100	42kA	72kA	130kA

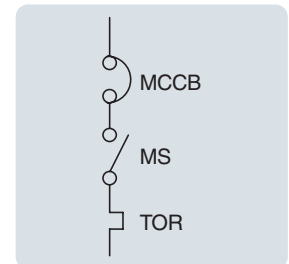

Motor		MCCB		Contactor	Thermal overload relay	
kW	A	Type	Rating Ir(A)	Type	Type	Setting range(A)
0.37	0.6	TD100	16	MC-9	MT-32	0.4~0.63
0.55	0.9	TD100	16	MC-9	MT-32	0.63-1
0.75	1.1	TD100	16	MC-9	MT-32	1-1.6
1.1	1.5	TD100	16	MC-9	MT-32	1-1.6
1.5	2	TD100	16	MC-32	MT-32	1.6-2.5
2.2	2.8	TD100	16	MC-32	MT-32	2.5-4
3	3.8	TD100	16	MC-32	MT-32	2.5-4
3.7	4.4	TD100	16	MC-40	MT-63	4-6
4	4.9	TD100	16	MC-40	MT-63	4-6
5.5	6.6	TD100	16	MC-40	MT-63	5-8
7.5	8.9	TD100	16	MC-40	MT-63	7-10
9	10.6	TD100	16	MC-85	MT-95	9-13
11	11.5	TD100	16	MC-85	MT-95	9-13
15	14	TD100	16	MC-85	MT-95	12-18
18.5	17.3	TD100	20	MC-85	MT-95	16-22
22	21.3	TD100	25	MC-85	MT-95	18-25
25	25.4	TD100	32	MC-85	MT-95	24-36
30	30.3	TD100	32	MC-85	MT-95	24-36
33	34.6	TD100 TS100	40	MC-85	MT-95	28-40
37	39	TD100 TS100	40	MC-85	MT-95	34-50
40	42	TD100 TS100	50	MC-85	MT-95	34-50
45	44	TD100 TS100	50	MC-85	MT-95	34-50

Type-2 coordination According to IEC60947-4-1

Performance: Ue=220V/240V		
MMS	S	H
MMS-32	50kA	100kA
MMS-63	50kA	100kA
MMS-100	100kA	100kA

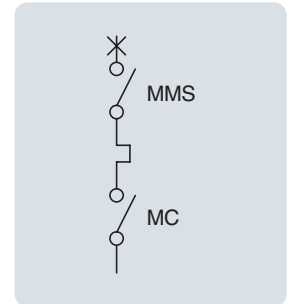

Motor		MMS		Contactor
kW	A	Type	Rating In(A)	Type
0.37	1.8	MMS-32H	2.5	MC-9
0.55	2.75	MMS-32H	4	MC-32
0.75	3.5	MMS-32H	4	MC-32
1.1	4.4	MMS-63H	10	MC-40
1.5	6.1	MMS-63H	10	MC-40
2.2	8.7	MMS-63H	13	MC-40
3	11.5	MMS-63H	13	MC-40
3.7	13.5	MMS-63H	18	MC-40
4	14.5	MMS-63H	18	MC-40
5.5	20	MMS-63H	22	MC-40
7.5	27	MMS-63H	32	MC-40
9	32	MMS-100S	32	MC-85
10	35	MMS-100S	40	MC-85
11	39	MMS-100S	40	MC-85
15	52	MMS-100S	63	MC-85
18.5	64	MMS-100S	75	MC-85
22	75	MMS-100S	75	MC-85
25	85	MMS-100S	90	MC-85

Technical information

Susol

Type-2 coordination

According to IEC60947-4-1

Performance: Ue=415V		
MMS	S	H
MMS-32	50kA	50kA
MMS-63	50kA	50kA
MMS-100	50kA	50kA

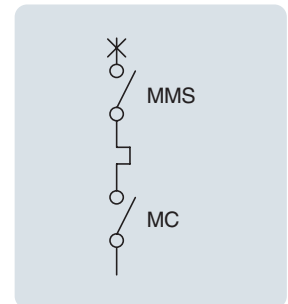

Motor		MMS		Contactor
kW	A	Type	Rating In(A)	Type
0.37	1.1	MMS-32S	1.6	MC-9
0.55	1.5	MMS-32S	1.6	MC-9
0.75	1.9	MMS-32S	2.5	MC-12
1.1	2.7	MMS-32S	4	MC-18
1.5	3.6	MMS-32S	4	MC-18
2.2	5.2	MMS-32S	6	MC-18
3	6.8	MMS-32S	8	MC-18
4	9	MMS-32S	10	MC-18
5.5	11.5	MMS-32H	13	MC-25
7.5	15.5	MMS-32H	17	MC-25
10	20	MMS-32H	22	MC-32
11	22	MMS-32H	26	MC-32
15	29	MMS-32H	32	MC-32
18.5	35	MMS-63H	40	MC-40
22	41	MMS-63H	50	MC-50
30	55	MMS-63H	63	MC-65
37	67	MMS-100S	75	MC-75
45	80	MMS-100S	100	MC-85

Type-2 coordination According to IEC60947-4-1

Performance: Ue=440V		
MMS	S	H
MMS-32	38kA	50kA
MMS-63	10kA	35kA
MMS-100	40kA	50kA

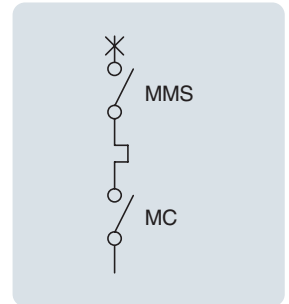

Motor		MMS		Contactor
kW	A	Type	Rating In(A)	Type
0.37	0.99	MMS-32S	1	MC-9
0.55	1.36	MMS-32S	1.6	MC-9
0.75	1.68	MMS-32S	2.5	MC-9
1.1	2.37	MMS-32S	2.5	MC-9
1.5	3.06	MMS-32S	4	MC-18
2.2	4.42	MMS-32H	6	MC-25
3	5.57	MMS-32H	6	MC-25
3.7	7.1	MMS-32H	8	MC-32
4	7.9	MMS-32H	8	MC-32
5.5	10.4	MMS-32H	13	MC-32
9	16.9	MMS-63H	17	MC-40
11	20.1	MMS-63H	22	MC-40
15	26.5	MMS-63H	32	MC-40
18.5	32.8	MMS-63H	40	MC-50
22	39	MMS-63H	40	MC-50
25	45.3	MMS-63H	50	MC-50
30	51.5	MMS-100S	63	MC-65
33	58	MMS-100S	63	MC-65
37	64	MMS-100S	63	MC-65
40	67	MMS-100S	75	MC-85
45	76	MMS-100S	75	MC-85

Memo

Susol



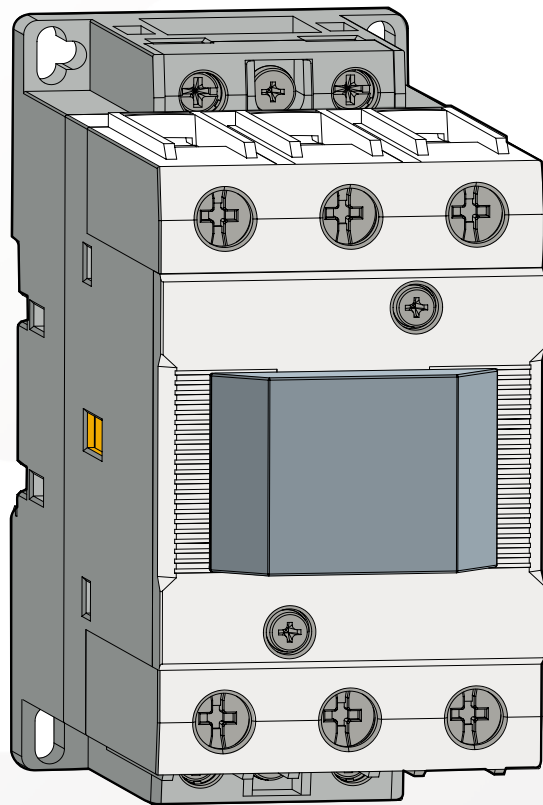

B-6. Catalogue numbers

Contactors

MC-9~32 screw only type	B-6-1
MC-35~95 lug type	B-6-6
MC-35~95 screw type	B-6-14
MC-9~32 screw only type 1a1b	B-6-22
MC-35~95 lug type 1a1b	B-6-27
MC-35~95 screw type 1a1b	B-6-35
MC-9~32 screw only type 2a2b	B-6-43
MC-35~95 lug type 2a2b	B-6-48
MC-35~95 screw type 2a2b	B-6-56

Overload relays

MT-32 screw only type	B-6-64
MT-63~95 lug type	B-6-65
MT-63~95 screw type	B-6-67

Accessories

Direct adapter	B-6-69
Surge unit	B-6-69
Interlock unit	B-6-70
Aux. Contact unit	B-6-70
Wire ass'y	B-6-70
Remote reset	B-6-71
Separate mounting adapter	B-6-71
Capacitor unit	B-6-71

Maunal Motor Starters

MMS-32	B-6-72
MMS-63 ~ MMS-100	B-6-73
Accessories	B-6-74

Catalogue numbers

Susol

Contactors

MC-9 screw only type



32AF

Model	Terminal type	Coil voltage	Frequency	Code
MC-9	Screw only	AC24V	50/60Hz	1275000100
		AC48V	50/60Hz	1275000200
		AC100V	50/60Hz	1275000300
		AC110V	50/60Hz	1275000400
		AC120V	50/60Hz	1275000500
		AC200V	50/60Hz	1275000600
		AC220V	50/60Hz	1275000700
		AC230V	50/60Hz	1275000800
		AC240V	50/60Hz	1275000900
		AC380V	50/60Hz	1275001000
		AC400V	50/60Hz	1275001100
		AC415V	50/60Hz	1275001200
		AC440V	50/60Hz	1275001300
		AC500V	50/60Hz	1275001400
		AC550V	50/60Hz	1275001500
		AC24V	50Hz	1275001600
		AC36V	50Hz	1275001700
		AC42V	50Hz	1275001800
		AC48V	50Hz	1275001900
		AC80V	50Hz	1275002000
		AC100V	50Hz	1275002100
		AC110V	50Hz	1275002200
		AC220V	50Hz	1275002300
		AC230V	50Hz	1275002400
		AC240V	50Hz	1275002500
		AC380V	50Hz	1275002600
		AC400V	50Hz	1275002700
		AC415V	50Hz	1275002800
		AC440V	50Hz	1275002900
		AC500V	50Hz	1275003000
		AC550V	50Hz	1275003100
		AC24V	60Hz	1275003200
		AC48V	60Hz	1275003300
		AC100V	60Hz	1275003400
		AC110V	60Hz	1275003500
		AC120V	60Hz	1275003600
		AC200V	60Hz	1275003700
		AC208V	60Hz	1275003800
		AC220V	60Hz	1275003900
		AC230V	60Hz	1275004000
		AC240V	60Hz	1275004100
		AC277V	60Hz	1275004200
		AC380V	60Hz	1275004300
		AC440V	60Hz	1275004400
		AC480V	60Hz	1275004500
		AC600V	60Hz	1275004600
		AC100V, AC110V	50Hz, 60Hz	1275004700
		AC110V, AC120V	50Hz, 60Hz	1275004800
		AC200V, AC220V	50Hz, 60Hz	1275004900
		AC240V, AC277V	50Hz, 60Hz	1275005000
DC12V		1275005100		
DC20V		1275005200		
DC24V		1275005300		
DC48V		1275005400		
DC60V		1275005500		
DC80V		1275005600		
DC100V		1275005700		
DC110V		1275005800		
DC125V		1275005900		
DC200V		1275006000		
DC250V		1275006100		

Catalogue numbers

Susol

Contactors

MC-12 screw only type



32AF

Model	Terminal type	Coil voltage	Frequency	Code
MC-12	Screw only	AC24V	50/60Hz	1276000100
		AC48V	50/60Hz	1276000200
		AC100V	50/60Hz	1276000300
		AC110V	50/60Hz	1276000400
		AC120V	50/60Hz	1276000500
		AC200V	50/60Hz	1276000600
		AC220V	50/60Hz	1276000700
		AC230V	50/60Hz	1276000800
		AC240V	50/60Hz	1276000900
		AC380V	50/60Hz	1276001000
		AC400V	50/60Hz	1276001100
		AC415V	50/60Hz	1276001200
		AC440V	50/60Hz	1276001300
		AC500V	50/60Hz	1276001400
		AC550V	50/60Hz	1276001500
		AC24V	50Hz	1276001600
		AC36V	50Hz	1276001700
		AC42V	50Hz	1276001800
		AC48V	50Hz	1276001900
		AC80V	50Hz	1276002000
		AC100V	50Hz	1276002100
		AC110V	50Hz	1276002200
		AC220V	50Hz	1276002300
		AC230V	50Hz	1276002400
		AC240V	50Hz	1276002500
		AC380V	50Hz	1276002600
		AC400V	50Hz	1276002700
		AC415V	50Hz	1276002800
		AC440V	50Hz	1276002900
		AC500V	50Hz	1276003000
		AC550V	50Hz	1276003100
		AC24V	60Hz	1276003200
		AC48V	60Hz	1276003300
		AC100V	60Hz	1276003400
		AC110V	60Hz	1276003500
		AC120V	60Hz	1276003600
		AC200V	60Hz	1276003700
		AC208V	60Hz	1276003800
		AC220V	60Hz	1276003900
		AC230V	60Hz	1276004000
		AC240V	60Hz	1276004100
		AC277V	60Hz	1276004200
		AC380V	60Hz	1276004300
		AC440V	60Hz	1276004400
		AC480V	60Hz	1276004500
		AC600V	60Hz	1276004600
		AC100V, AC110V	50Hz, 60Hz	1276004700
		AC110V, AC120V	50Hz, 60Hz	1276004800
		AC200V, AC220V	50Hz, 60Hz	1276004900
		AC240V, AC277V	50Hz, 60Hz	1276005000
DC12V		1276005100		
DC20V		1276005200		
DC24V		1276005300		
DC48V		1276005400		
DC60V		1276005500		
DC80V		1276005600		
DC100V		1276005700		
DC110V		1276005800		
DC125V		1276005900		
DC200V		1276006000		
DC250V		1276006100		

Catalogue numbers

Susol

Contactors

MC-18 screw only type



32AF

Model	Terminal type	Coil voltage	Frequency	Code
MC-18	Screw only	AC24V	50/60Hz	1277000100
		AC48V	50/60Hz	1277000200
		AC100V	50/60Hz	1277000300
		AC110V	50/60Hz	1277000400
		AC120V	50/60Hz	1277000500
		AC200V	50/60Hz	1277000600
		AC220V	50/60Hz	1277000700
		AC230V	50/60Hz	1277000800
		AC240V	50/60Hz	1277000900
		AC380V	50/60Hz	1277001000
		AC400V	50/60Hz	1277001100
		AC415V	50/60Hz	1277001200
		AC440V	50/60Hz	1277001300
		AC500V	50/60Hz	1277001400
		AC550V	50/60Hz	1277001500
		AC24V	50Hz	1277001600
		AC36V	50Hz	1277001700
		AC42V	50Hz	1277001800
		AC48V	50Hz	1277001900
		AC80V	50Hz	1277002000
		AC100V	50Hz	1277002100
		AC110V	50Hz	1277002200
		AC220V	50Hz	1277002300
		AC230V	50Hz	1277002400
		AC240V	50Hz	1277002500
		AC380V	50Hz	1277002600
		AC400V	50Hz	1277002700
		AC415V	50Hz	1277002800
		AC440V	50Hz	1277002900
		AC500V	50Hz	1277003000
		AC550V	50Hz	1277003100
		AC24V	60Hz	1277003200
		AC48V	60Hz	1277003300
		AC100V	60Hz	1277003400
		AC110V	60Hz	1277003500
		AC120V	60Hz	1277003600
		AC200V	60Hz	1277003700
		AC208V	60Hz	1277003800
		AC220V	60Hz	1277003900
		AC230V	60Hz	1277004000
		AC240V	60Hz	1277004100
		AC277V	60Hz	1277004200
		AC380V	60Hz	1277004300
		AC440V	60Hz	1277004400
		AC480V	60Hz	1277004500
		AC600V	60Hz	1277004600
		AC100V, AC110V	50Hz, 60Hz	1277004700
		AC110V, AC120V	50Hz, 60Hz	1277004800
		AC200V, AC220V	50Hz, 60Hz	1277004900
		AC240V, AC277V	50Hz, 60Hz	1277005000
DC12V		1277005100		
DC20V		1277005200		
DC24V		1277005300		
DC48V		1277005400		
DC60V		1277005500		
DC80V		1277005600		
DC100V		1277005700		
DC110V		1277005800		
DC125V		1277005900		
DC200V		1277006000		
DC250V		1277006100		

Catalogue numbers

Susol

Contactors

MC-25 screw only type



32AF

Model	Terminal type	Coil voltage	Frequency	Code
MC-25	Screw only	AC24V	50/60Hz	1278000100
		AC48V	50/60Hz	1278000200
		AC100V	50/60Hz	1278000300
		AC110V	50/60Hz	1278000400
		AC120V	50/60Hz	1278000500
		AC200V	50/60Hz	1278000600
		AC220V	50/60Hz	1278000700
		AC230V	50/60Hz	1278000800
		AC240V	50/60Hz	1278000900
		AC380V	50/60Hz	1278001000
		AC400V	50/60Hz	1278001100
		AC415V	50/60Hz	1278001200
		AC440V	50/60Hz	1278001300
		AC500V	50/60Hz	1278001400
		AC550V	50/60Hz	1278001500
		AC24V	50Hz	1278001600
		AC36V	50Hz	1278001700
		AC42V	50Hz	1278001800
		AC48V	50Hz	1278001900
		AC80V	50Hz	1278002000
		AC100V	50Hz	1278002100
		AC110V	50Hz	1278002200
		AC220V	50Hz	1278002300
		AC230V	50Hz	1278002400
		AC240V	50Hz	1278002500
		AC380V	50Hz	1278002600
		AC400V	50Hz	1278002700
		AC415V	50Hz	1278002800
		AC440V	50Hz	1278002900
		AC500V	50Hz	1278003000
		AC550V	50Hz	1278003100
		AC24V	60Hz	1278003200
		AC48V	60Hz	1278003300
		AC100V	60Hz	1278003400
		AC110V	60Hz	1278003500
		AC120V	60Hz	1278003600
		AC200V	60Hz	1278003700
		AC208V	60Hz	1278003800
		AC220V	60Hz	1278003900
		AC230V	60Hz	1278004000
		AC240V	60Hz	1278004100
		AC277V	60Hz	1278004200
		AC380V	60Hz	1278004300
		AC440V	60Hz	1278004400
		AC480V	60Hz	1278004500
		AC600V	60Hz	1278004600
		AC100V, AC110V	50Hz, 60Hz	1278004700
		AC110V, AC120V	50Hz, 60Hz	1278004800
		AC200V, AC220V	50Hz, 60Hz	1278004900
		AC240V, AC277V	50Hz, 60Hz	1278005000
DC12V		1278005100		
DC20V		1278005200		
DC24V		1278005300		
DC48V		1278005400		
DC60V		1278005500		
DC80V		1278005600		
DC100V		1278005700		
DC110V		1278005800		
DC125V		1278005900		
DC200V		1278006000		
DC250V		1278006100		

Catalogue numbers

Susol

Contactors

MC-32 screw only type



32AF

Model	Terminal type	Coil voltage	Frequency	Code
MC-32	Screw only	AC24V	50/60Hz	1279000100
		AC48V	50/60Hz	1279000200
		AC100V	50/60Hz	1279000300
		AC110V	50/60Hz	1279000400
		AC120V	50/60Hz	1279000500
		AC200V	50/60Hz	1279000600
		AC220V	50/60Hz	1279000700
		AC230V	50/60Hz	1279000800
		AC240V	50/60Hz	1279000900
		AC380V	50/60Hz	1279001000
		AC400V	50/60Hz	1279001100
		AC415V	50/60Hz	1279001200
		AC440V	50/60Hz	1279001300
		AC500V	50/60Hz	1279001400
		AC550V	50/60Hz	1279001500
		AC24V	50Hz	1279001600
		AC36V	50Hz	1279001700
		AC42V	50Hz	1279001800
		AC48V	50Hz	1279001900
		AC80V	50Hz	1279002000
		AC100V	50Hz	1279002100
		AC110V	50Hz	1279002200
		AC220V	50Hz	1279002300
		AC230V	50Hz	1279002400
		AC240V	50Hz	1279002500
		AC380V	50Hz	1279002600
		AC400V	50Hz	1279002700
		AC415V	50Hz	1279002800
		AC440V	50Hz	1279002900
		AC500V	50Hz	1279003000
		AC550V	50Hz	1279003100
		AC24V	60Hz	1279003200
		AC48V	60Hz	1279003300
		AC100V	60Hz	1279003400
		AC110V	60Hz	1279003500
		AC120V	60Hz	1279003600
		AC200V	60Hz	1279003700
		AC208V	60Hz	1279003800
		AC220V	60Hz	1279003900
		AC230V	60Hz	1279004000
		AC240V	60Hz	1279004100
		AC277V	60Hz	1279004200
		AC380V	60Hz	1279004300
		AC440V	60Hz	1279004400
		AC480V	60Hz	1279004500
		AC600V	60Hz	1279004600
		AC100V, AC110V	50Hz, 60Hz	1279004700
		AC110V, AC120V	50Hz, 60Hz	1279004800
		AC200V, AC220V	50Hz, 60Hz	1279004900
		AC240V, AC277V	50Hz, 60Hz	1279005000
DC12V		1279005100		
DC20V		1279005200		
DC24V		1279005300		
DC48V		1279005400		
DC60V		1279005500		
DC80V		1279005600		
DC100V		1279005700		
DC110V		1279005800		
DC125V		1279005900		
DC200V		1279006000		
DC250V		1279006100		

Catalogue numbers

Susol

Contactors

MC-35 lug type



63AF

Model	Terminal type	Coil voltage	Frequency	Code
MC-35	Lug	AC24V	50/60Hz	1280000100
		AC48V	50/60Hz	1280000200
		AC100V	50/60Hz	1280000300
		AC110V	50/60Hz	1280000400
		AC120V	50/60Hz	1280000500
		AC200V	50/60Hz	1280000600
		AC220V	50/60Hz	1280000700
		AC230V	50/60Hz	1280000800
		AC240V	50/60Hz	1280000900
		AC380V	50/60Hz	1280001000
		AC400V	50/60Hz	1280001100
		AC415V	50/60Hz	1280001200
		AC440V	50/60Hz	1280001300
		AC500V	50/60Hz	1280001400
		AC550V	50/60Hz	1280001500
		AC24V	50Hz	1280001600
		AC36V	50Hz	1280001700
		AC42V	50Hz	1280001800
		AC48V	50Hz	1280001900
		AC80V	50Hz	1280002000
		AC100V	50Hz	1280002100
		AC110V	50Hz	1280002200
		AC220V	50Hz	1280002300
		AC230V	50Hz	1280002400
		AC240V	50Hz	1280002500
		AC380V	50Hz	1280002600
		AC400V	50Hz	1280002700
		AC415V	50Hz	1280002800
		AC440V	50Hz	1280002900
		AC500V	50Hz	1280003000
		AC550V	50Hz	1280003100
		AC24V	60Hz	1280003200
		AC48V	60Hz	1280003300
		AC100V	60Hz	1280003400
		AC110V	60Hz	1280003500
		AC120V	60Hz	1280003600
		AC200V	60Hz	1280003700
		AC208V	60Hz	1280003800
		AC220V	60Hz	1280003900
		AC230V	60Hz	1280004000
		AC240V	60Hz	1280004100
		AC277V	60Hz	1280004200
		AC380V	60Hz	1280004300
		AC440V	60Hz	1280004400
		AC480V	60Hz	1280004500
		AC600V	60Hz	1280004600
		AC100V, AC110V	50Hz, 60Hz	1280004700
		AC110V, AC120V	50Hz, 60Hz	1280004800
		AC200V, AC220V	50Hz, 60Hz	1280004900
		AC240V, AC277V	50Hz, 60Hz	1280005000
DC12V		1280005100		
DC20V		1280005200		
DC24V		1280005300		
DC48V		1280005400		
DC60V		1280005500		
DC80V		1280005600		
DC100V		1280005700		
DC110V		1280005800		
DC125V		1280005900		
DC200V		1280006000		
DC250V		1280006100		

Catalogue numbers

Susol

Contactors

MC-40 lug type



63AF

Model	Terminal type	Coil voltage	Frequency	Code
MC-40	Lug	AC24V	50/60Hz	1281000100
		AC48V	50/60Hz	1281000200
		AC100V	50/60Hz	1281000300
		AC110V	50/60Hz	1281000400
		AC120V	50/60Hz	1281000500
		AC200V	50/60Hz	1281000600
		AC220V	50/60Hz	1281000700
		AC230V	50/60Hz	1281000800
		AC240V	50/60Hz	1281000900
		AC380V	50/60Hz	1281001000
		AC400V	50/60Hz	1281001100
		AC415V	50/60Hz	1281001200
		AC440V	50/60Hz	1281001300
		AC500V	50/60Hz	1281001400
		AC550V	50/60Hz	1281001500
		AC24V	50Hz	1281001600
		AC36V	50Hz	1281001700
		AC42V	50Hz	1281001800
		AC48V	50Hz	1281001900
		AC80V	50Hz	1281002000
		AC100V	50Hz	1281002100
		AC110V	50Hz	1281002200
		AC220V	50Hz	1281002300
		AC230V	50Hz	1281002400
		AC240V	50Hz	1281002500
		AC380V	50Hz	1281002600
		AC400V	50Hz	1281002700
		AC415V	50Hz	1281002800
		AC440V	50Hz	1281002900
		AC500V	50Hz	1281003000
		AC550V	50Hz	1281003100
		AC24V	60Hz	1281003200
		AC48V	60Hz	1281003300
		AC100V	60Hz	1281003400
		AC110V	60Hz	1281003500
		AC120V	60Hz	1281003600
		AC200V	60Hz	1281003700
		AC208V	60Hz	1281003800
		AC220V	60Hz	1281003900
		AC230V	60Hz	1281004000
		AC240V	60Hz	1281004100
		AC277V	60Hz	1281004200
		AC380V	60Hz	1281004300
		AC440V	60Hz	1281004400
		AC480V	60Hz	1281004500
		AC600V	60Hz	1281004600
		AC100V, AC110V	50Hz, 60Hz	1281004700
		AC110V, AC120V	50Hz, 60Hz	1281004800
		AC200V, AC220V	50Hz, 60Hz	1281004900
		AC240V, AC277V	50Hz, 60Hz	1281005000
DC12V		1281005100		
DC20V		1281005200		
DC24V		1281005300		
DC48V		1281005400		
DC60V		1281005500		
DC80V		1281005600		
DC100V		1281005700		
DC110V		1281005800		
DC125V		1281005900		
DC200V		1281006000		
DC250V		1281006100		

Catalogue numbers

Susol

Contactors

MC-50 lug type



63AF

Model	Terminal type	Coil voltage	Frequency	Code
MC-50	Lug	AC24V	50/60Hz	1282000100
		AC48V	50/60Hz	1282000200
		AC100V	50/60Hz	1282000300
		AC110V	50/60Hz	1282000400
		AC120V	50/60Hz	1282000500
		AC200V	50/60Hz	1282000600
		AC220V	50/60Hz	1282000700
		AC230V	50/60Hz	1282000800
		AC240V	50/60Hz	1282000900
		AC380V	50/60Hz	1282001000
		AC400V	50/60Hz	1282001100
		AC415V	50/60Hz	1282001200
		AC440V	50/60Hz	1282001300
		AC500V	50/60Hz	1282001400
		AC550V	50/60Hz	1282001500
		AC24V	50Hz	1282001600
		AC36V	50Hz	1282001700
		AC42V	50Hz	1282001800
		AC48V	50Hz	1282001900
		AC80V	50Hz	1282002000
		AC100V	50Hz	1282002100
		AC110V	50Hz	1282002200
		AC220V	50Hz	1282002300
		AC230V	50Hz	1282002400
		AC240V	50Hz	1282002500
		AC380V	50Hz	1282002600
		AC400V	50Hz	1282002700
		AC415V	50Hz	1282002800
		AC440V	50Hz	1282002900
		AC500V	50Hz	1282003000
		AC550V	50Hz	1282003100
		AC24V	60Hz	1282003200
		AC48V	60Hz	1282003300
		AC100V	60Hz	1282003400
		AC110V	60Hz	1282003500
		AC120V	60Hz	1282003600
		AC200V	60Hz	1282003700
		AC208V	60Hz	1282003800
		AC220V	60Hz	1282003900
		AC230V	60Hz	1282004000
		AC240V	60Hz	1282004100
		AC277V	60Hz	1282004200
		AC380V	60Hz	1282004300
		AC440V	60Hz	1282004400
		AC480V	60Hz	1282004500
		AC600V	60Hz	1282004600
		AC100V, AC110V	50Hz, 60Hz	1282004700
		AC110V, AC120V	50Hz, 60Hz	1282004800
		AC200V, AC220V	50Hz, 60Hz	1282004900
		AC240V, AC277V	50Hz, 60Hz	1282005000
DC12V		1282005100		
DC20V		1282005200		
DC24V		1282005300		
DC48V		1282005400		
DC60V		1282005500		
DC80V		1282005600		
DC100V		1282005700		
DC110V		1282005800		
DC125V		1282005900		
DC200V		1282006000		
DC250V		1282006100		

Catalogue numbers

Susol

Contactors

MC-63 lug type



63AF

Model	Terminal type	Coil voltage	Frequency	Code
MC-63	Lug	AC24V	50/60Hz	1283000100
		AC48V	50/60Hz	1283000200
		AC100V	50/60Hz	1283000300
		AC110V	50/60Hz	1283000400
		AC120V	50/60Hz	1283000500
		AC200V	50/60Hz	1283000600
		AC220V	50/60Hz	1283000700
		AC230V	50/60Hz	1283000800
		AC240V	50/60Hz	1283000900
		AC380V	50/60Hz	1283001000
		AC400V	50/60Hz	1283001100
		AC415V	50/60Hz	1283001200
		AC440V	50/60Hz	1283001300
		AC500V	50/60Hz	1283001400
		AC550V	50/60Hz	1283001500
		AC24V	50Hz	1283001600
		AC36V	50Hz	1283001700
		AC42V	50Hz	1283001800
		AC48V	50Hz	1283001900
		AC80V	50Hz	1283002000
		AC100V	50Hz	1283002100
		AC110V	50Hz	1283002200
		AC220V	50Hz	1283002300
		AC230V	50Hz	1283002400
		AC240V	50Hz	1283002500
		AC380V	50Hz	1283002600
		AC400V	50Hz	1283002700
		AC415V	50Hz	1283002800
		AC440V	50Hz	1283002900
		AC500V	50Hz	1283003000
		AC550V	50Hz	1283003100
		AC24V	60Hz	1283003200
		AC48V	60Hz	1283003300
		AC100V	60Hz	1283003400
		AC110V	60Hz	1283003500
		AC120V	60Hz	1283003600
		AC200V	60Hz	1283003700
		AC208V	60Hz	1283003800
		AC220V	60Hz	1283003900
		AC230V	60Hz	1283004000
		AC240V	60Hz	1283004100
		AC277V	60Hz	1283004200
		AC380V	60Hz	1283004300
		AC440V	60Hz	1283004400
		AC480V	60Hz	1283004500
		AC600V	60Hz	1283004600
		AC100V, AC110V	50Hz, 60Hz	1283004700
		AC110V, AC120V	50Hz, 60Hz	1283004800
		AC200V, AC220V	50Hz, 60Hz	1283004900
		AC240V, AC277V	50Hz, 60Hz	1283005000
DC12V		1283005100		
DC20V		1283005200		
DC24V		1283005300		
DC48V		1283005400		
DC60V		1283005500		
DC80V		1283005600		
DC100V		1283005700		
DC110V		1283005800		
DC125V		1283005900		
DC200V		1283006000		
DC250V		1283006100		

Catalogue numbers

Susol

Contactors

MC-65 lug type



95AF

Model	Terminal type	Coil voltage	Frequency	Code
MC-65	Lug	AC24V	50/60Hz	1284000100
		AC48V	50/60Hz	1284000200
		AC100V	50/60Hz	1284000300
		AC110V	50/60Hz	1284000400
		AC120V	50/60Hz	1284000500
		AC200V	50/60Hz	1284000600
		AC220V	50/60Hz	1284000700
		AC230V	50/60Hz	1284000800
		AC240V	50/60Hz	1284000900
		AC380V	50/60Hz	1284001000
		AC400V	50/60Hz	1284001100
		AC415V	50/60Hz	1284001200
		AC440V	50/60Hz	1284001300
		AC500V	50/60Hz	1284001400
		AC550V	50/60Hz	1284001500
		AC24V	50Hz	1284001600
		AC36V	50Hz	1284001700
		AC42V	50Hz	1284001800
		AC48V	50Hz	1284001900
		AC80V	50Hz	1284002000
		AC100V	50Hz	1284002100
		AC110V	50Hz	1284002200
		AC220V	50Hz	1284002300
		AC230V	50Hz	1284002400
		AC240V	50Hz	1284002500
		AC380V	50Hz	1284002600
		AC400V	50Hz	1284002700
		AC415V	50Hz	1284002800
		AC440V	50Hz	1284002900
		AC500V	50Hz	1284003000
		AC550V	50Hz	1284003100
		AC24V	60Hz	1284003200
		AC48V	60Hz	1284003300
		AC100V	60Hz	1284003400
		AC110V	60Hz	1284003500
		AC120V	60Hz	1284003600
		AC200V	60Hz	1284003700
		AC208V	60Hz	1284003800
		AC220V	60Hz	1284003900
		AC230V	60Hz	1284004000
		AC240V	60Hz	1284004100
		AC277V	60Hz	1284004200
		AC380V	60Hz	1284004300
		AC440V	0Hz	1284004400
		AC480V	60Hz	1284004500
		AC600V	60Hz	1284004600
		AC100V, AC110V	50Hz, 60Hz	1284004700
		AC110V, AC120V	50Hz, 60Hz	1284004800
		AC200V, AC220V	50Hz, 60Hz	1284004900
		AC240V, AC277V	50Hz, 60Hz	1284005000
DC12V		1284005100		
DC20V		1284005200		
DC24V		1284005300		
DC48V		1284005400		
DC60V		1284005500		
DC80V		1284005600		
DC100V		1284005700		
DC110V		1284005800		
DC125V		1284005900		
DC200V		1284006000		
DC250V		1284006100		

Catalogue numbers

Susol

Contactors

MC-75 lug type



95AF

Model	Terminal type	Coil voltage	Frequency	Code
MC-75	Lug	AC24V	50/60Hz	1285000100
		AC48V	50/60Hz	1285000200
		AC100V	50/60Hz	1285000300
		AC110V	50/60Hz	1285000400
		AC120V	50/60Hz	1285000500
		AC200V	50/60Hz	1285000600
		AC220V	50/60Hz	1285000700
		AC230V	50/60Hz	1285000800
		AC240V	50/60Hz	1285000900
		AC380V	50/60Hz	1285001000
		AC400V	50/60Hz	1285001100
		AC415V	50/60Hz	1285001200
		AC440V	50/60Hz	1285001300
		AC500V	50/60Hz	1285001400
		AC550V	50/60Hz	1285001500
		AC24V	50Hz	1285001600
		AC36V	50Hz	1285001700
		AC42V	50Hz	1285001800
		AC48V	50Hz	1285001900
		AC80V	50Hz	1285002000
		AC100V	50Hz	1285002100
		AC110V	50Hz	1285002200
		AC220V	50Hz	1285002300
		AC230V	50Hz	1285002400
		AC240V	50Hz	1285002500
		AC380V	50Hz	1285002600
		AC400V	50Hz	1285002700
		AC415V	50Hz	1285002800
		AC440V	50Hz	1285002900
		AC500V	50Hz	1285003000
		AC550V	50Hz	1285003100
		AC24V	60Hz	1285003200
		AC48V	60Hz	1285003300
		AC100V	60Hz	1285003400
		AC110V	60Hz	1285003500
		AC120V	60Hz	1285003600
		AC200V	60Hz	1285003700
		AC208V	60Hz	1285003800
		AC220V	60Hz	1285003900
		AC230V	60Hz	1285004000
		AC240V	60Hz	1285004100
		AC277V	60Hz	1285004200
		AC380V	60Hz	1285004300
		AC440V	60Hz	1285004400
		AC480V	60Hz	1285004500
		AC600V	60Hz	1285004600
		AC100V, AC110V	50Hz, 60Hz	1285004700
		AC110V, AC120V	50Hz, 60Hz	1285004800
		AC200V, AC220V	50Hz, 60Hz	1285004900
		AC240V, AC277V	50Hz, 60Hz	1285005000
DC12V		1285005100		
DC20V		1285005200		
DC24V		1285005300		
DC48V		1285005400		
DC60V		1285005500		
DC80V		1285005600		
DC100V		1285005700		
DC110V		1285005800		
DC125V		1285005900		
DC200V		1285006000		
DC250V		1285006100		

Catalogue numbers

Susol

Contactors

MC-85 lug type



95AF

Model	Terminal type	Coil voltage	Frequency	Code
MC-85	Lug	AC24V	50/60Hz	1286000100
		AC48V	50/60Hz	1286000200
		AC100V	50/60Hz	1286000300
		AC110V	50/60Hz	1286000400
		AC120V	50/60Hz	1286000500
		AC200V	50/60Hz	1286000600
		AC220V	50/60Hz	1286000700
		AC230V	50/60Hz	1286000800
		AC240V	50/60Hz	1286000900
		AC380V	50/60Hz	1286001000
		AC400V	50/60Hz	1286001100
		AC415V	50/60Hz	1286001200
		AC440V	50/60Hz	1286001300
		AC500V	50/60Hz	1286001400
		AC550V	50/60Hz	1286001500
		AC24V	50Hz	1286001600
		AC36V	50Hz	1286001700
		AC42V	50Hz	1286001800
		AC48V	50Hz	1286001900
		AC80V	50Hz	1286002000
		AC100V	50Hz	1286002100
		AC110V	50Hz	1286002200
		AC220V	50Hz	1286002300
		AC230V	50Hz	1286002400
		AC240V	50Hz	1286002500
		AC380V	50Hz	1286002600
		AC400V	50Hz	1286002700
		AC415V	50Hz	1286002800
		AC440V	50Hz	1286002900
		AC500V	50Hz	1286003000
		AC550V	50Hz	1286003100
		AC24V	60Hz	1286003200
		AC48V	60Hz	1286003300
		AC100V	60Hz	1286003400
		AC110V	60Hz	1286003500
		AC120V	60Hz	1286003600
		AC200V	60Hz	1286003700
		AC208V	60Hz	1286003800
		AC220V	60Hz	1286003900
		AC230V	60Hz	1286004000
		AC240V	60Hz	1286004100
		AC277V	60Hz	1286004200
		AC380V	60Hz	1286004300
		AC440V	60Hz	1286004400
		AC480V	60Hz	1286004500
		AC600V	60Hz	1286004600
		AC100V, AC110V	50Hz, 60Hz	1286004700
		AC110V, AC120V	50Hz, 60Hz	1286004800
		AC200V, AC220V	50Hz, 60Hz	1286004900
		AC240V, AC277V	50Hz, 60Hz	1286005000
DC12V		1286005100		
DC20V		1286005200		
DC24V		1286005300		
DC48V		1286005400		
DC60V		1286005500		
DC80V		1286005600		
DC100V		1286005700		
DC110V		1286005800		
DC125V		1286005900		
DC200V		1286006000		
DC250V		1286006100		

Catalogue numbers

Susol

Contactors

MC-95 lug type



95AF

Model	Terminal type	Coil voltage	Frequency	Code
MC-95	Lug	AC24V	50/60Hz	1287000100
		AC48V	50/60Hz	1287000200
		AC100V	50/60Hz	1287000300
		AC110V	50/60Hz	1287000400
		AC120V	50/60Hz	1287000500
		AC200V	50/60Hz	1287000600
		AC220V	50/60Hz	1287000700
		AC230V	50/60Hz	1287000800
		AC240V	50/60Hz	1287000900
		AC380V	50/60Hz	1287001000
		AC400V	50/60Hz	1287001100
		AC415V	50/60Hz	1287001200
		AC440V	50/60Hz	1287001300
		AC500V	50/60Hz	1287001400
		AC550V	50/60Hz	1287001500
		AC24V	50Hz	1287001600
		AC36V	50Hz	1287001700
		AC42V	50Hz	1287001800
		AC48V	50Hz	1287001900
		AC80V	50Hz	1287002000
		AC100V	50Hz	1287002100
		AC110V	50Hz	1287002200
		AC220V	50Hz	1287002300
		AC230V	50Hz	1287002400
		AC240V	50Hz	1287002500
		AC380V	50Hz	1287002600
		AC400V	50Hz	1287002700
		AC415V	50Hz	1287002800
		AC440V	50Hz	1287002900
		AC500V	50Hz	1287003000
		AC550V	50Hz	1287003100
		AC24V	60Hz	1287003200
		AC48V	60Hz	1287003300
		AC100V	60Hz	1287003400
		AC110V	60Hz	1287003500
		AC120V	60Hz	1287003600
		AC200V	60Hz	1287003700
		AC208V	60Hz	1287003800
		AC220V	60Hz	1287003900
		AC230V	60Hz	1287004000
		AC240V	60Hz	1287004100
		AC277V	60Hz	1287004200
		AC380V	60Hz	1287004300
		AC440V	60Hz	1287004400
		AC480V	60Hz	1287004500
		AC600V	60Hz	1287004600
		AC100V, AC110V	50Hz, 60Hz	1287004700
		AC110V, AC120V	50Hz, 60Hz	1287004800
		AC200V, AC220V	50Hz, 60Hz	1287004900
		AC240V, AC277V	50Hz, 60Hz	1287005000
DC12V		1287005100		
DC20V		1287005200		
DC24V		1287005300		
DC48V		1287005400		
DC60V		1287005500		
DC80V		1287005600		
DC100V		1287005700		
DC110V		1287005800		
DC125V		1287005900		
DC200V		1287006000		
DC250V		1287006100		

Catalogue numbers

Susol

Contactors

MC-35 screw type



63AF

Model	Terminal type	Coil voltage	Frequency	Code
MC-35	Screw	AC24V	50/60Hz	1288000100
		AC48V	50/60Hz	1288000200
		AC100V	50/60Hz	1288000300
		AC110V	50/60Hz	1288000400
		AC120V	50/60Hz	1288000500
		AC200V	50/60Hz	1288000600
		AC220V	50/60Hz	1288000700
		AC230V	50/60Hz	1288000800
		AC240V	50/60Hz	1288000900
		AC380V	50/60Hz	1288001000
		AC400V	50/60Hz	1288001100
		AC415V	50/60Hz	1288001200
		AC440V	50/60Hz	1288001300
		AC500V	50/60Hz	1288001400
		AC550V	50/60Hz	1288001500
		AC24V	50Hz	1288001600
		AC36V	50Hz	1288001700
		AC42V	50Hz	1288001800
		AC48V	50Hz	1288001900
		AC80V	50Hz	1288002000
		AC100V	50Hz	1288002100
		AC110V	50Hz	1288002200
		AC220V	50Hz	1288002300
		AC230V	50Hz	1288002400
		AC240V	50Hz	1288002500
		AC380V	50Hz	1288002600
		AC400V	50Hz	1288002700
		AC415V	50Hz	1288002800
		AC440V	50Hz	1288002900
		AC500V	50Hz	1288003000
		AC550V	50Hz	1288003100
		AC24V	60Hz	1288003200
		AC48V	60Hz	1288003300
		AC100V	60Hz	1288003400
		AC110V	60Hz	1288003500
		AC120V	60Hz	1288003600
		AC200V	60Hz	1288003700
		AC208V	60Hz	1288003800
		AC220V	60Hz	1288003900
		AC230V	60Hz	1288004000
		AC240V	60Hz	1288004100
		AC277V	60Hz	1288004200
		AC380V	60Hz	1288004300
		AC440V	60Hz	1288004400
		AC480V	60Hz	1288004500
		AC600V	60Hz	1288004600
		AC100V, AC110V	50Hz, 60Hz	1288004700
		AC110V, AC120V	50Hz, 60Hz	1288004800
		AC200V, AC220V	50Hz, 60Hz	1288004900
		AC240V, AC277V	50Hz, 60Hz	1288005000
DC12V		1288005100		
DC20V		1288005200		
DC24V		1288005300		
DC48V		1288005400		
DC60V		1288005500		
DC80V		1288005600		
DC100V		1288005700		
DC110V		1288005800		
DC125V		1288005900		
DC200V		1288006000		
DC250V		1288006100		

Catalogue numbers

Susol

Contactors

MC-40 screw type



63AF

Model	Terminal type	Coil voltage	Frequency	Code
MC-40	Screw	AC24V	50/60Hz	1289000100
		AC48V	50/60Hz	1289000200
		AC100V	50/60Hz	1289000300
		AC110V	50/60Hz	1289000400
		AC120V	50/60Hz	1289000500
		AC200V	50/60Hz	1289000600
		AC220V	50/60Hz	1289000700
		AC230V	50/60Hz	1289000800
		AC240V	50/60Hz	1289000900
		AC380V	50/60Hz	1289001000
		AC400V	50/60Hz	1289001100
		AC415V	50/60Hz	1289001200
		AC440V	50/60Hz	1289001300
		AC500V	50/60Hz	1289001400
		AC550V	50/60Hz	1289001500
		AC24V	50Hz	1289001600
		AC36V	50Hz	1289001700
		AC42V	50Hz	1289001800
		AC48V	50Hz	1289001900
		AC80V	50Hz	1289002000
		AC100V	50Hz	1289002100
		AC110V	50Hz	1289002200
		AC220V	50Hz	1289002300
		AC230V	50Hz	1289002400
		AC240V	50Hz	1289002500
		AC380V	50Hz	1289002600
		AC400V	50Hz	1289002700
		AC415V	50Hz	1289002800
		AC440V	50Hz	1289002900
		AC500V	50Hz	1289003000
		AC550V	50Hz	1289003100
		AC24V	60Hz	1289003200
		AC48V	60Hz	1289003300
		AC100V	60Hz	1289003400
		AC110V	60Hz	1289003500
		AC120V	60Hz	1289003600
		AC200V	60Hz	1289003700
		AC208V	60Hz	1289003800
		AC220V	60Hz	1289003900
		AC230V	60Hz	1289004000
		AC240V	60Hz	1289004100
		AC277V	60Hz	1289004200
		AC380V	60Hz	1289004300
		AC440V	60Hz	1289004400
		AC480V	60Hz	1289004500
		AC600V	60Hz	1289004600
		AC100V, AC110V	50Hz, 60Hz	1289004700
		AC110V, AC120V	50Hz, 60Hz	1289004800
		AC200V, AC220V	50Hz, 60Hz	1289004900
		AC240V, AC277V	50Hz, 60Hz	1289005000
DC12V		1289005100		
DC20V		1289005200		
DC24V		1289005300		
DC48V		1289005400		
DC60V		1289005500		
DC80V		1289005600		
DC100V		1289005700		
DC110V		1289005800		
DC125V		1289005900		
DC200V		1289006000		
DC250V		1289006100		

Catalogue numbers

Susol

Contactors

MC-50 screw type



63AF

Model	Terminal type	Coil voltage	Frequency	Code
MC-50	Screw	AC24V	50/60Hz	1290000100
		AC48V	50/60Hz	1290000200
		AC100V	50/60Hz	1290000300
		AC110V	50/60Hz	1290000400
		AC120V	50/60Hz	1290000500
		AC200V	50/60Hz	1290000600
		AC220V	50/60Hz	1290000700
		AC230V	50/60Hz	1290000800
		AC240V	50/60Hz	1290000900
		AC380V	50/60Hz	1290001000
		AC400V	50/60Hz	1290001100
		AC415V	50/60Hz	1290001200
		AC440V	50/60Hz	1290001300
		AC500V	50/60Hz	1290001400
		AC550V	50/60Hz	1290001500
		AC24V	50Hz	1290001600
		AC36V	50Hz	1290001700
		AC42V	50Hz	1290001800
		AC48V	50Hz	1290001900
		AC80V	50Hz	1290002000
		AC100V	50Hz	1290002100
		AC110V	50Hz	1290002200
		AC220V	50Hz	1290002300
		AC230V	50Hz	1290002400
		AC240V	50Hz	1290002500
		AC380V	50Hz	1290002600
		AC400V	50Hz	1290002700
		AC415V	50Hz	1290002800
		AC440V	50Hz	1290002900
		AC500V	50Hz	1290003000
		AC550V	50Hz	1290003100
		AC24V	60Hz	1290003200
		AC48V	60Hz	1290003300
		AC100V	60Hz	1290003400
		AC110V	60Hz	1290003500
		AC120V	60Hz	1290003600
		AC200V	60Hz	1290003700
		AC208V	60Hz	1290003800
		AC220V	60Hz	1290003900
		AC230V	60Hz	1290004000
		AC240V	60Hz	1290004100
		AC277V	60Hz	1290004200
		AC380V	60Hz	1290004300
		AC440V	60Hz	1290004400
		AC480V	60Hz	1290004500
		AC600V	60Hz	1290004600
		AC100V, AC110V	50Hz, 60Hz	1290004700
		AC110V, AC120V	50Hz, 60Hz	1290004800
		AC200V, AC220V	50Hz, 60Hz	1290004900
		AC240V, AC277V	50Hz, 60Hz	1290005000
DC12V		1290005100		
DC20V		1290005200		
DC24V		1290005300		
DC48V		1290005400		
DC60V		1290005500		
DC80V		1290005600		
DC100V		1290005700		
DC110V		1290005800		
DC125V		1290005900		
DC200V		1290006000		
DC250V		1290006100		

Catalogue numbers

Susol

Contactors

MC-63 screw type



63AF

Model	Terminal type	Coil voltage	Frequency	Code
MC-63	Screw	AC24V	50/60Hz	1291000100
		AC48V	50/60Hz	1291000200
		AC100V	50/60Hz	1291000300
		AC110V	50/60Hz	1291000400
		AC120V	50/60Hz	1291000500
		AC200V	50/60Hz	1291000600
		AC220V	50/60Hz	1291000700
		AC230V	50/60Hz	1291000800
		AC240V	50/60Hz	1291000900
		AC380V	50/60Hz	1291001000
		AC400V	50/60Hz	1291001100
		AC415V	50/60Hz	1291001200
		AC440V	50/60Hz	1291001300
		AC500V	50/60Hz	1291001400
		AC550V	50/60Hz	1291001500
		AC24V	50Hz	1291001600
		AC36V	50Hz	1291001700
		AC42V	50Hz	1291001800
		AC48V	50Hz	1291001900
		AC80V	50Hz	1291002000
		AC100V	50Hz	1291002100
		AC110V	50Hz	1291002200
		AC220V	50Hz	1291002300
		AC230V	50Hz	1291002400
		AC240V	50Hz	1291002500
		AC380V	50Hz	1291002600
		AC400V	50Hz	1291002700
		AC415V	50Hz	1291002800
		AC440V	50Hz	1291002900
		AC500V	50Hz	1291003000
		AC550V	50Hz	1291003100
		AC24V	60Hz	1291003200
		AC48V	60Hz	1291003300
		AC100V	60Hz	1291003400
		AC110V	60Hz	1291003500
		AC120V	60Hz	1291003600
		AC200V	60Hz	1291003700
		AC208V	60Hz	1291003800
		AC220V	60Hz	1291003900
		AC230V	60Hz	1291004000
		AC240V	60Hz	1291004100
		AC277V	60Hz	1291004200
		AC380V	60Hz	1291004300
		AC440V	60Hz	1291004400
		AC480V	60Hz	1291004500
		AC600V	60Hz	1291004600
		AC100V, AC110V	50Hz, 60Hz	1291004700
		AC110V, AC120V	50Hz, 60Hz	1291004800
		AC200V, AC220V	50Hz, 60Hz	1291004900
		AC240V, AC277V	50Hz, 60Hz	1291005000
DC12V		1291005100		
DC20V		1291005200		
DC24V		1291005300		
DC48V		1291005400		
DC60V		1291005500		
DC80V		1291005600		
DC100V		1291005700		
DC110V		1291005800		
DC125V		1291005900		
DC200V		1291006000		
DC250V		1291006100		

Catalogue numbers

Susol

Contactors

MC-65 screw type



95AF

Model	Terminal type	Coil voltage	Frequency	Code
MC-65	Screw	AC24V	50/60Hz	1292000100
		AC48V	50/60Hz	1292000200
		AC100V	50/60Hz	1292000300
		AC110V	50/60Hz	1292000400
		AC120V	50/60Hz	1292000500
		AC200V	50/60Hz	1292000600
		AC220V	50/60Hz	1292000700
		AC230V	50/60Hz	1292000800
		AC240V	50/60Hz	1292000900
		AC380V	50/60Hz	1292001000
		AC400V	50/60Hz	1292001100
		AC415V	50/60Hz	1292001200
		AC440V	50/60Hz	1292001300
		AC500V	50/60Hz	1292001400
		AC550V	50/60Hz	1292001500
		AC24V	50Hz	1292001600
		AC36V	50Hz	1292001700
		AC42V	50Hz	1292001800
		AC48V	50Hz	1292001900
		AC80V	50Hz	1292002000
		AC100V	50Hz	1292002100
		AC110V	50Hz	1292002200
		AC220V	50Hz	1292002300
		AC230V	50Hz	1292002400
		AC240V	50Hz	1292002500
		AC380V	50Hz	1292002600
		AC400V	50Hz	1292002700
		AC415V	50Hz	1292002800
		AC440V	50Hz	1292002900
		AC500V	50Hz	1292003000
		AC550V	50Hz	1292003100
		AC24V	60Hz	1292003200
		AC48V	60Hz	1292003300
		AC100V	60Hz	1292003400
		AC110V	60Hz	1292003500
		AC120V	60Hz	1292003600
		AC200V	60Hz	1292003700
		AC208V	60Hz	1292003800
		AC220V	60Hz	1292003900
		AC230V	60Hz	1292004000
		AC240V	60Hz	1292004100
		AC277V	60Hz	1292004200
		AC380V	60Hz	1292004300
		AC440V	60Hz	1292004400
		AC480V	60Hz	1292004500
		AC600V	60Hz	1292004600
		AC100V, AC110V	50Hz, 60Hz	1292004700
		AC110V, AC120V	50Hz, 60Hz	1292004800
		AC200V, AC220V	50Hz, 60Hz	1292004900
		AC240V, AC277V	50Hz, 60Hz	1292005000
DC12V		1292005100		
DC20V		1292005200		
DC24V		1292005300		
DC48V		1292005400		
DC60V		1292005500		
DC80V		1292005600		
DC100V		1292005700		
DC110V		1292005800		
DC125V		1292005900		
DC200V		1292006000		
DC250V		1292006100		

Catalogue numbers

Susol

Contactors

MC-75 screw type



95AF

Model	Terminal type	Coil voltage	Frequency	Code
MC-75	Screw	AC24V	50/60Hz	1293000100
		AC48V	50/60Hz	1293000200
		AC100V	50/60Hz	1293000300
		AC110V	50/60Hz	1293000400
		AC120V	50/60Hz	1293000500
		AC200V	50/60Hz	1293000600
		AC220V	50/60Hz	1293000700
		AC230V	50/60Hz	1293000800
		AC240V	50/60Hz	1293000900
		AC380V	50/60Hz	1293001000
		AC400V	50/60Hz	1293001100
		AC415V	50/60Hz	1293001200
		AC440V	50/60Hz	1293001300
		AC500V	50/60Hz	1293001400
		AC550V	50/60Hz	1293001500
		AC24V	50Hz	1293001600
		AC36V	50Hz	1293001700
		AC42V	50Hz	1293001800
		AC48V	50Hz	1293001900
		AC80V	50Hz	1293002000
		AC100V	50Hz	1293002100
		AC110V	50Hz	1293002200
		AC220V	50Hz	1293002300
		AC230V	50Hz	1293002400
		AC240V	50Hz	1293002500
		AC380V	50Hz	1293002600
		AC400V	50Hz	1293002700
		AC415V	50Hz	1293002800
		AC440V	50Hz	1293002900
		AC500V	50Hz	1293003000
		AC550V	50Hz	1293003100
		AC24V	60Hz	1293003200
		AC48V	60Hz	1293003300
		AC100V	60Hz	1293003400
		AC110V	60Hz	1293003500
		AC120V	60Hz	1293003600
		AC200V	60Hz	1293003700
		AC208V	60Hz	1293003800
		AC220V	60Hz	1293003900
		AC230V	60Hz	1293004000
		AC240V	60Hz	1293004100
		AC277V	60Hz	1293004200
		AC380V	60Hz	1293004300
		AC440V	60Hz	1293004400
		AC480V	60Hz	1293004500
		AC600V	60Hz	1293004600
		AC100V, AC110V	50Hz, 60Hz	1293004700
		AC110V, AC120V	50Hz, 60Hz	1293004800
		AC200V, AC220V	50Hz, 60Hz	1293004900
		AC240V, AC277V	50Hz, 60Hz	1293005000
DC12V		1293005100		
DC20V		1293005200		
DC24V		1293005300		
DC48V		1293005400		
DC60V		1293005500		
DC80V		1293005600		
DC100V		1293005700		
DC110V		1293005800		
DC125V		1293005900		
DC200V		1293006000		
DC250V		1293006100		

Catalogue numbers

Susol

Contactors

MC-85 screw type



95AF

Model	Terminal type	Coil voltage	Frequency	Code
MC-85	Screw	AC24V	50/60Hz	1294000100
		AC48V	50/60Hz	1294000200
		AC100V	50/60Hz	1294000300
		AC110V	50/60Hz	1294000400
		AC120V	50/60Hz	1294000500
		AC200V	50/60Hz	1294000600
		AC220V	50/60Hz	1294000700
		AC230V	50/60Hz	1294000800
		AC240V	50/60Hz	1294000900
		AC380V	50/60Hz	1294001000
		AC400V	50/60Hz	1294001100
		AC415V	50/60Hz	1294001200
		AC440V	50/60Hz	1294001300
		AC500V	50/60Hz	1294001400
		AC550V	50/60Hz	1294001500
		AC24V	50Hz	1294001600
		AC36V	50Hz	1294001700
		AC42V	50Hz	1294001800
		AC48V	50Hz	1294001900
		AC80V	50Hz	1294002000
		AC100V	50Hz	1294002100
		AC110V	50Hz	1294002200
		AC220V	50Hz	1294002300
		AC230V	50Hz	1294002400
		AC240V	50Hz	1294002500
		AC380V	50Hz	1294002600
		AC400V	50Hz	1294002700
		AC415V	50Hz	1294002800
		AC440V	50Hz	1294002900
		AC500V	50Hz	1294003000
		AC550V	50Hz	1294003100
		AC24V	60Hz	1294003200
		AC48V	60Hz	1294003300
		AC100V	60Hz	1294003400
		AC110V	60Hz	1294003500
		AC120V	60Hz	1294003600
		AC200V	60Hz	1294003700
		AC208V	60Hz	1294003800
		AC220V	60Hz	1294003900
		AC230V	60Hz	1294004000
		AC240V	60Hz	1294004100
		AC277V	60Hz	1294004200
		AC380V	60Hz	1294004300
		AC440V	60Hz	1294004400
		AC480V	60Hz	1294004500
		AC600V	60Hz	1294004600
		AC100V, AC110V	50Hz, 60Hz	1294004700
		AC110V, AC120V	50Hz, 60Hz	1294004800
		AC200V, AC220V	50Hz, 60Hz	1294004900
		AC240V, AC277V	50Hz, 60Hz	1294005000
DC12V		1294005100		
DC20V		1294005200		
DC24V		1294005300		
DC48V		1294005400		
DC60V		1294005500		
DC80V		1294005600		
DC100V		1294005700		
DC110V		1294005800		
DC125V		1294005900		
DC200V		1294006000		
DC250V		1294006100		

Catalogue numbers

Susol

Contactors

MC-95 screw type



95AF

Model	Terminal type	Coil voltage	Frequency	Code
MC-95	Screw	AC24V	50/60Hz	1295000100
		AC48V	50/60Hz	1295000200
		AC100V	50/60Hz	1295000300
		AC110V	50/60Hz	1295000400
		AC120V	50/60Hz	1295000500
		AC200V	50/60Hz	1295000600
		AC220V	50/60Hz	1295000700
		AC230V	50/60Hz	1295000800
		AC240V	50/60Hz	1295000900
		AC380V	50/60Hz	1295001000
		AC400V	50/60Hz	1295001100
		AC415V	50/60Hz	1295001200
		AC440V	50/60Hz	1295001300
		AC500V	50/60Hz	1295001400
		AC550V	50/60Hz	1295001500
		AC24V	50Hz	1295001600
		AC36V	50Hz	1295001700
		AC42V	50Hz	1295001800
		AC48V	50Hz	1295001900
		AC80V	50Hz	1295002000
		AC100V	50Hz	1295002100
		AC110V	50Hz	1295002200
		AC220V	50Hz	1295002300
		AC230V	50Hz	1295002400
		AC240V	50Hz	1295002500
		AC380V	50Hz	1295002600
		AC400V	50Hz	1295002700
		AC415V	50Hz	1295002800
		AC440V	50Hz	1295002900
		AC500V	50Hz	1295003000
		AC550V	50Hz	1295003100
		AC24V	60Hz	1295003200
		AC48V	60Hz	1295003300
		AC100V	60Hz	1295003400
		AC110V	60Hz	1295003500
		AC120V	60Hz	1295003600
		AC200V	60Hz	1295003700
		AC208V	60Hz	1295003800
		AC220V	60Hz	1295003900
		AC230V	60Hz	1295004000
		AC240V	60Hz	1295004100
		AC277V	60Hz	1295004200
		AC380V	60Hz	1295004300
		AC440V	60Hz	1295004400
		AC480V	60Hz	1295004500
		AC600V	60Hz	1295004600
		AC100V, AC110V	50Hz, 60Hz	1295004700
		AC110V, AC120V	50Hz, 60Hz	1295004800
		AC200V, AC220V	50Hz, 60Hz	1295004900
		AC240V, AC277V	50Hz, 60Hz	1295005000
DC12V		1295005100		
DC20V		1295005200		
DC24V		1295005300		
DC48V		1295005400		
DC60V		1295005500		
DC80V		1295005600		
DC100V		1295005700		
DC110V		1295005800		
DC125V		1295005900		
DC200V		1295006000		
DC250V		1295006100		

Catalogue numbers

Susol

Contactors

MC-9 screw only type 1a1b



32AF

Model	Terminal type	Coil voltage	Frequency	Aux.contact	Code
MC-9	Screw only	AC24V	50/60Hz	1a1b	1275006300
		AC48V	50/60Hz	1a1b	1275006400
		AC100V	50/60Hz	1a1b	1275006500
		AC110V	50/60Hz	1a1b	1275006600
		AC120V	50/60Hz	1a1b	1275006700
		AC200V	50/60Hz	1a1b	1275006800
		AC220V	50/60Hz	1a1b	1275006900
		AC230V	50/60Hz	1a1b	1275007000
		AC240V	50/60Hz	1a1b	1275007100
		AC380V	50/60Hz	1a1b	1275007200
		AC400V	50/60Hz	1a1b	1275007300
		AC415V	50/60Hz	1a1b	1275007400
		AC440V	50/60Hz	1a1b	1275007500
		AC500V	50/60Hz	1a1b	1275007600
		AC550V	50/60Hz	1a1b	1275007700
		AC24V	50Hz	1a1b	1275007800
		AC36V	50Hz	1a1b	1275007900
		AC42V	50Hz	1a1b	1275008000
		AC48V	50Hz	1a1b	1275008100
		AC80V	50Hz	1a1b	1275008200
		AC100V	50Hz	1a1b	1275008300
		AC110V	50Hz	1a1b	1275008400
		AC220V	50Hz	1a1b	1275008500
		AC230V	50Hz	1a1b	1275008600
		AC240V	50Hz	1a1b	1275008700
		AC380V	50Hz	1a1b	1275008800
		AC400V	50Hz	1a1b	1275008900
		AC415V	50Hz	1a1b	1275009000
		AC440V	50Hz	1a1b	1275009100
		AC500V	50Hz	1a1b	1275009200
		AC550V	50Hz	1a1b	1275009300
		AC24V	60Hz	1a1b	1275009400
		AC48V	60Hz	1a1b	1275009500
		AC100V	60Hz	1a1b	1275009600
		AC110V	60Hz	1a1b	1275009700
		AC120V	60Hz	1a1b	1275009800
		AC200V	60Hz	1a1b	1275009900
		AC208V	60Hz	1a1b	1275010000
		AC220V	60Hz	1a1b	1275010100
		AC230V	60Hz	1a1b	1275010200
		AC240V	60Hz	1a1b	1275010300
		AC277V	60Hz	1a1b	1275010400
		AC380V	60Hz	1a1b	1275010500
		AC440V	60Hz	1a1b	1275010600
		AC480V	60Hz	1a1b	1275010700
		AC600V	60Hz	1a1b	1275010800
		AC100V, AC110V	50Hz, 60Hz	1a1b	1275010900
AC110V, AC120V	50Hz, 60Hz	1a1b	1275011000		
AC200V, AC220V	50Hz, 60Hz	1a1b	1275011100		
AC240V, AC277V	50Hz, 60Hz	1a1b	1275011200		
DC12V		1a1b	1275011300		
DC20V		1a1b	1275011400		
DC24V		1a1b	1275011500		
DC48V		1a1b	1275011600		
DC60V		1a1b	1275011700		
DC80V		1a1b	1275011800		
DC100V		1a1b	1275011900		
DC110V		1a1b	1275012000		
DC125V		1a1b	1275012100		
DC200V		1a1b	1275012200		
DC220V		1a1b	1275012300		
DC250V		1a1b	1275012400		

Catalogue numbers

Susol

Contactors

MC-12 screw only type 1a1b



32AF

Model	Terminal type	Coil voltage	Frequency	Aux.contact	Code
MC-12	Screw only	AC24V	50/60Hz	1a1b	1276006300
		AC48V	50/60Hz	1a1b	1276006400
		AC100V	50/60Hz	1a1b	1276006500
		AC110V	50/60Hz	1a1b	1276006600
		AC120V	50/60Hz	1a1b	1276006700
		AC200V	50/60Hz	1a1b	1276006800
		AC220V	50/60Hz	1a1b	1276006900
		AC230V	50/60Hz	1a1b	1276007000
		AC240V	50/60Hz	1a1b	1276007100
		AC380V	50/60Hz	1a1b	1276007200
		AC400V	50/60Hz	1a1b	1276007300
		AC415V	50/60Hz	1a1b	1276007400
		AC440V	50/60Hz	1a1b	1276007500
		AC500V	50/60Hz	1a1b	1276007600
		AC550V	50/60Hz	1a1b	1276007700
		AC24V	50Hz	1a1b	1276007800
		AC36V	50Hz	1a1b	1276007900
		AC42V	50Hz	1a1b	1276008000
		AC48V	50Hz	1a1b	1276008100
		AC80V	50Hz	1a1b	1276008200
		AC100V	50Hz	1a1b	1276008300
		AC110V	50Hz	1a1b	1276008400
		AC220V	50Hz	1a1b	1276008500
		AC230V	50Hz	1a1b	1276008600
		AC240V	50Hz	1a1b	1276008700
		AC380V	50Hz	1a1b	1276008800
		AC400V	50Hz	1a1b	1276008900
		AC415V	50Hz	1a1b	1276009000
		AC440V	50Hz	1a1b	1276009100
		AC500V	50Hz	1a1b	1276009200
		AC550V	50Hz	1a1b	1276009300
		AC24V	60Hz	1a1b	1276009400
		AC48V	60Hz	1a1b	1276009500
		AC100V	60Hz	1a1b	1276009600
		AC110V	60Hz	1a1b	1276009700
		AC120V	60Hz	1a1b	1276009800
		AC200V	60Hz	1a1b	1276009900
		AC208V	60Hz	1a1b	1276010000
		AC220V	60Hz	1a1b	1276010100
		AC230V	60Hz	1a1b	1276010200
		AC240V	60Hz	1a1b	1276010300
		AC277V	60Hz	1a1b	1276010400
		AC380V	60Hz	1a1b	1276010500
		AC440V	60Hz	1a1b	1276010600
		AC480V	60Hz	1a1b	1276010700
		AC600V	60Hz	1a1b	1276010800
		AC100V, AC110V	50Hz, 60Hz	1a1b	1276010900
		AC110V, AC120V	50Hz, 60Hz	1a1b	1276011000
		AC200V, AC220V	50Hz, 60Hz	1a1b	1276011100
		AC240V, AC277V	50Hz, 60Hz	1a1b	1276011200
DC12V		1a1b	1276011300		
DC20V		1a1b	1276011400		
DC24V		1a1b	1276011500		
DC48V		1a1b	1276011600		
DC60V		1a1b	1276011700		
DC80V		1a1b	1276011800		
DC100V		1a1b	1276011900		
DC110V		1a1b	1276012000		
DC125V		1a1b	1276012100		
DC200V		1a1b	1276012200		
DC220V		1a1b	1276012300		
DC250V		1a1b	1276012400		

Catalogue numbers

Susol

Contactors

MC-18 screw only type 1a1b



32AF

Model	Terminal type	Coil voltage	Frequency	Aux.contact	Code
MC-18	Screw only	AC24V	50/60Hz	1a1b	1277006300
		AC48V	50/60Hz	1a1b	1277006400
		AC100V	50/60Hz	1a1b	1277006500
		AC110V	50/60Hz	1a1b	1277006600
		AC120V	50/60Hz	1a1b	1277006700
		AC200V	50/60Hz	1a1b	1277006800
		AC220V	50/60Hz	1a1b	1277006900
		AC230V	50/60Hz	1a1b	1277007000
		AC240V	50/60Hz	1a1b	1277007100
		AC380V	50/60Hz	1a1b	1277007200
		AC400V	50/60Hz	1a1b	1277007300
		AC415V	50/60Hz	1a1b	1277007400
		AC440V	50/60Hz	1a1b	1277007500
		AC500V	50/60Hz	1a1b	1277007600
		AC550V	50/60Hz	1a1b	1277007700
		AC24V	50Hz	1a1b	1277007800
		AC36V	50Hz	1a1b	1277007900
		AC42V	50Hz	1a1b	1277008000
		AC48V	50Hz	1a1b	1277008100
		AC80V	50Hz	1a1b	1277008200
		AC100V	50Hz	1a1b	1277008300
		AC110V	50Hz	1a1b	1277008400
		AC220V	50Hz	1a1b	1277008500
		AC230V	50Hz	1a1b	1277008600
		AC240V	50Hz	1a1b	1277008700
		AC380V	50Hz	1a1b	1277008800
		AC400V	50Hz	1a1b	1277008900
		AC415V	50Hz	1a1b	1277009000
		AC440V	50Hz	1a1b	1277009100
		AC500V	50Hz	1a1b	1277009200
		AC550V	50Hz	1a1b	1277009300
		AC24V	60Hz	1a1b	1277009400
		AC48V	60Hz	1a1b	1277009500
		AC100V	60Hz	1a1b	1277009600
		AC110V	60Hz	1a1b	1277009700
		AC120V	60Hz	1a1b	1277009800
		AC200V	60Hz	1a1b	1277009900
		AC208V	60Hz	1a1b	1277010000
		AC220V	60Hz	1a1b	1277010100
		AC230V	60Hz	1a1b	1277010200
		AC240V	60Hz	1a1b	1277010300
		AC277V	60Hz	1a1b	1277010400
		AC380V	60Hz	1a1b	1277010500
		AC440V	60Hz	1a1b	1277010600
		AC480V	60Hz	1a1b	1277010700
		AC600V	60Hz	1a1b	1277010800
AC100V, AC110V	50Hz, 60Hz	1a1b	1277010900		
AC110V, AC120V	50Hz, 60Hz	1a1b	1277011000		
AC200V, AC220V	50Hz, 60Hz	1a1b	1277011100		
AC240V, AC277V	50Hz, 60Hz	1a1b	1277011200		
DC12V		1a1b	1277011300		
DC20V		1a1b	1277011400		
DC24V		1a1b	1277011500		
DC48V		1a1b	1277011600		
DC60V		1a1b	1277011700		
DC80V		1a1b	1277011800		
DC100V		1a1b	1277011900		
DC110V		1a1b	1277012000		
DC125V		1a1b	1277012100		
DC200V		1a1b	1277012200		
DC220V		1a1b	1277012300		
DC250V		1a1b	1277012400		

Catalogue numbers

Susol

Contactors

MC-25 screw only type 1a1b



32AF

Model	Terminal type	Coil voltage	Frequency	Aux.contact	Code
MC-25	Screw only	AC24V	50/60Hz	1a1b	1278006300
		AC48V	50/60Hz	1a1b	1278006400
		AC100V	50/60Hz	1a1b	1278006500
		AC110V	50/60Hz	1a1b	1278006600
		AC120V	50/60Hz	1a1b	1278006700
		AC200V	50/60Hz	1a1b	1278006800
		AC220V	50/60Hz	1a1b	1278006900
		AC230V	50/60Hz	1a1b	1278007000
		AC240V	50/60Hz	1a1b	1278007100
		AC380V	50/60Hz	1a1b	1278007200
		AC400V	50/60Hz	1a1b	1278007300
		AC415V	50/60Hz	1a1b	1278007400
		AC440V	50/60Hz	1a1b	1278007500
		AC500V	50/60Hz	1a1b	1278007600
		AC550V	50/60Hz	1a1b	1278007700
		AC24V	50Hz	1a1b	1278007800
		AC36V	50Hz	1a1b	1278007900
		AC42V	50Hz	1a1b	1278008000
		AC48V	50Hz	1a1b	1278008100
		AC80V	50Hz	1a1b	1278008200
		AC100V	50Hz	1a1b	1278008300
		AC110V	50Hz	1a1b	1278008400
		AC220V	50Hz	1a1b	1278008500
		AC230V	50Hz	1a1b	1278008600
		AC240V	50Hz	1a1b	1278008700
		AC380V	50Hz	1a1b	1278008800
		AC400V	50Hz	1a1b	1278008900
		AC415V	50Hz	1a1b	1278009000
		AC440V	50Hz	1a1b	1278009100
		AC500V	50Hz	1a1b	1278009200
		AC550V	50Hz	1a1b	1278009300
		AC24V	60Hz	1a1b	1278009400
		AC48V	60Hz	1a1b	1278009500
		AC100V	60Hz	1a1b	1278009600
		AC110V	60Hz	1a1b	1278009700
		AC120V	60Hz	1a1b	1278009800
		AC200V	60Hz	1a1b	1278009900
		AC208V	60Hz	1a1b	1278010000
		AC220V	60Hz	1a1b	1278010100
		AC230V	60Hz	1a1b	1278010200
		AC240V	60Hz	1a1b	1278010300
		AC277V	60Hz	1a1b	1278010400
		AC380V	60Hz	1a1b	1278010500
		AC440V	60Hz	1a1b	1278010600
		AC480V	60Hz	1a1b	1278010700
		AC600V	60Hz	1a1b	1278010800
		AC100V, AC110V	50Hz, 60Hz	1a1b	1278010900
		AC110V, AC120V	50Hz, 60Hz	1a1b	1278011000
		AC200V, AC220V	50Hz, 60Hz	1a1b	1278011100
		AC240V, AC277V	50Hz, 60Hz	1a1b	1278011200
DC12V		1a1b	1278011300		
DC20V		1a1b	1278011400		
DC24V		1a1b	1278011500		
DC48V		1a1b	1278011600		
DC60V		1a1b	1278011700		
DC80V		1a1b	1278011800		
DC100V		1a1b	1278011900		
DC110V		1a1b	1278012000		
DC125V		1a1b	1278012100		
DC200V		1a1b	1278012200		
DC220V		1a1b	1278012300		
DC250V		1a1b	1278012400		

Catalogue numbers

Susol

Contactors

MC-32 screw only type 1a1b



32AF

Model	Terminal type	Coil voltage	Frequency	Aux.contact	Code
MC-32	Screw only	AC24V	50/60Hz	1a1b	1279006300
		AC48V	50/60Hz	1a1b	1279006400
		AC100V	50/60Hz	1a1b	1279006500
		AC110V	50/60Hz	1a1b	1279006600
		AC120V	50/60Hz	1a1b	1279006700
		AC200V	50/60Hz	1a1b	1279006800
		AC220V	50/60Hz	1a1b	1279006900
		AC230V	50/60Hz	1a1b	1279007000
		AC240V	50/60Hz	1a1b	1279007100
		AC380V	50/60Hz	1a1b	1279007200
		AC400V	50/60Hz	1a1b	1279007300
		AC415V	50/60Hz	1a1b	1279007400
		AC440V	50/60Hz	1a1b	1279007500
		AC500V	50/60Hz	1a1b	1279007600
		AC550V	50/60Hz	1a1b	1279007700
		AC24V	50Hz	1a1b	1279007800
		AC36V	50Hz	1a1b	1279007900
		AC42V	50Hz	1a1b	1279008000
		AC48V	50Hz	1a1b	1279008100
		AC80V	50Hz	1a1b	1279008200
		AC100V	50Hz	1a1b	1279008300
		AC110V	50Hz	1a1b	1279008400
		AC220V	50Hz	1a1b	1279008500
		AC230V	50Hz	1a1b	1279008600
		AC240V	50Hz	1a1b	1279008700
		AC380V	50Hz	1a1b	1279008800
		AC400V	50Hz	1a1b	1279008900
		AC415V	50Hz	1a1b	1279009000
		AC440V	50Hz	1a1b	1279009100
		AC500V	50Hz	1a1b	1279009200
		AC550V	50Hz	1a1b	1279009300
		AC24V	60Hz	1a1b	1279009400
		AC48V	60Hz	1a1b	1279009500
		AC100V	60Hz	1a1b	1279009600
		AC110V	60Hz	1a1b	1279009700
		AC120V	60Hz	1a1b	1279009800
		AC200V	60Hz	1a1b	1279009900
		AC208V	60Hz	1a1b	1279010000
		AC220V	60Hz	1a1b	1279010100
		AC230V	60Hz	1a1b	1279010200
		AC240V	60Hz	1a1b	1279010300
		AC277V	60Hz	1a1b	1279010400
		AC380V	60Hz	1a1b	1279010500
		AC440V	60Hz	1a1b	1279010600
		AC480V	60Hz	1a1b	1279010700
		AC600V	60Hz	1a1b	1279010800
		AC100V, AC110V	50Hz, 60Hz	1a1b	1279010900
AC110V, AC120V	50Hz, 60Hz	1a1b	1279011000		
AC200V, AC220V	50Hz, 60Hz	1a1b	1279011100		
AC240V, AC277V	50Hz, 60Hz	1a1b	1279011200		
DC12V		1a1b	1279011300		
DC20V		1a1b	1279011400		
DC24V		1a1b	1279011500		
DC48V		1a1b	1279011600		
DC60V		1a1b	1279011700		
DC80V		1a1b	1279011800		
DC100V		1a1b	1279011900		
DC110V		1a1b	1279012000		
DC125V		1a1b	1279012100		
DC200V		1a1b	1279012200		
DC220V		1a1b	1279012300		
DC250V		1a1b	1279012400		

Catalogue numbers

Susol

Contactors

MC-35 lug type 1a1b



63AF

Model	Terminal type	Coil voltage	Frequency	Aux.contact	Code
MC-35	Lug	AC24V	50/60Hz	1a1b	1280006300
		AC48V	50/60Hz	1a1b	1280006400
		AC100V	50/60Hz	1a1b	1280006500
		AC110V	50/60Hz	1a1b	1280006600
		AC120V	50/60Hz	1a1b	1280006700
		AC200V	50/60Hz	1a1b	1280006800
		AC220V	50/60Hz	1a1b	1280006900
		AC230V	50/60Hz	1a1b	1280007000
		AC240V	50/60Hz	1a1b	1280007100
		AC380V	50/60Hz	1a1b	1280007200
		AC400V	50/60Hz	1a1b	1280007300
		AC415V	50/60Hz	1a1b	1280007400
		AC440V	50/60Hz	1a1b	1280007500
		AC500V	50/60Hz	1a1b	1280007600
		AC550V	50/60Hz	1a1b	1280007700
		AC24V	50Hz	1a1b	1280007800
		AC36V	50Hz	1a1b	1280007900
		AC42V	50Hz	1a1b	1280008000
		AC48V	50Hz	1a1b	1280008100
		AC80V	50Hz	1a1b	1280008200
		AC100V	50Hz	1a1b	1280008300
		AC110V	50Hz	1a1b	1280008400
		AC220V	50Hz	1a1b	1280008500
		AC230V	50Hz	1a1b	1280008600
		AC240V	50Hz	1a1b	1280008700
		AC380V	50Hz	1a1b	1280008800
		AC400V	50Hz	1a1b	1280008900
		AC415V	50Hz	1a1b	1280009000
		AC440V	50Hz	1a1b	1280009100
		AC500V	50Hz	1a1b	1280009200
		AC550V	50Hz	1a1b	1280009300
		AC24V	60Hz	1a1b	1280009400
		AC48V	60Hz	1a1b	1280009500
		AC100V	60Hz	1a1b	1280009600
		AC110V	60Hz	1a1b	1280009700
		AC120V	60Hz	1a1b	1280009800
		AC200V	60Hz	1a1b	1280009900
		AC208V	60Hz	1a1b	1280010000
		AC220V	60Hz	1a1b	1280010100
		AC230V	60Hz	1a1b	1280010200
		AC240V	60Hz	1a1b	1280010300
		AC277V	60Hz	1a1b	1280010400
AC380V	60Hz	1a1b	1280010500		
AC440V	60Hz	1a1b	1280010600		
AC480V	60Hz	1a1b	1280010700		
AC600V	60Hz	1a1b	1280010800		
AC100V, AC110V	50Hz, 60Hz	1a1b	1280010900		
AC110V, AC120V	50Hz, 60Hz	1a1b	1280011000		
AC200V, AC220V	50Hz, 60Hz	1a1b	1280011100		
AC240V, AC277V	50Hz, 60Hz	1a1b	1280011200		
DC12V		1a1b	1280011300		
DC20V		1a1b	1280011400		
DC24V		1a1b	1280011500		
DC48V		1a1b	1280011600		
DC60V		1a1b	1280011700		
DC80V		1a1b	1280011800		
DC100V		1a1b	1280011900		
DC110V		1a1b	1280012000		
DC125V		1a1b	1280012100		
DC200V		1a1b	1280012200		
DC220V		1a1b	1280012300		
DC250V		1a1b	1280012400		

Catalogue numbers

Susol

Contactors

MC-40 lug type 1a1b



63AF

Model	Terminal type	Coil voltage	Frequency	Aux.contact	Code
MC-40	Lug	AC24V	50/60Hz	1a1b	1281006300
		AC48V	50/60Hz	1a1b	1281006400
		AC100V	50/60Hz	1a1b	1281006500
		AC110V	50/60Hz	1a1b	1281006600
		AC120V	50/60Hz	1a1b	1281006700
		AC200V	50/60Hz	1a1b	1281006800
		AC220V	50/60Hz	1a1b	1281006900
		AC230V	50/60Hz	1a1b	1281007000
		AC240V	50/60Hz	1a1b	1281007100
		AC380V	50/60Hz	1a1b	1281007200
		AC400V	50/60Hz	1a1b	1281007300
		AC415V	50/60Hz	1a1b	1281007400
		AC440V	50/60Hz	1a1b	1281007500
		AC500V	50/60Hz	1a1b	1281007600
		AC550V	50/60Hz	1a1b	1281007700
		AC24V	50Hz	1a1b	1281007800
		AC36V	50Hz	1a1b	1281007900
		AC42V	50Hz	1a1b	1281008000
		AC48V	50Hz	1a1b	1281008100
		AC80V	50Hz	1a1b	1281008200
		AC100V	50Hz	1a1b	1281008300
		AC110V	50Hz	1a1b	1281008400
		AC220V	50Hz	1a1b	1281008500
		AC230V	50Hz	1a1b	1281008600
		AC240V	50Hz	1a1b	1281008700
		AC380V	50Hz	1a1b	1281008800
		AC400V	50Hz	1a1b	1281008900
		AC415V	50Hz	1a1b	1281009000
		AC440V	50Hz	1a1b	1281009100
		AC500V	50Hz	1a1b	1281009200
		AC550V	50Hz	1a1b	1281009300
		AC24V	60Hz	1a1b	1281009400
		AC48V	60Hz	1a1b	1281009500
		AC100V	60Hz	1a1b	1281009600
		AC110V	60Hz	1a1b	1281009700
		AC120V	60Hz	1a1b	1281009800
		AC200V	60Hz	1a1b	1281009900
		AC208V	60Hz	1a1b	1281010000
		AC220V	60Hz	1a1b	1281010100
		AC230V	60Hz	1a1b	1281010200
		AC240V	60Hz	1a1b	1281010300
		AC277V	60Hz	1a1b	1281010400
		AC380V	60Hz	1a1b	1281010500
		AC440V	60Hz	1a1b	1281010600
		AC480V	60Hz	1a1b	1281010700
		AC600V	60Hz	1a1b	1281010800
		AC100V, AC110V	50Hz, 60Hz	1a1b	1281010900
AC110V, AC120V	50Hz, 60Hz	1a1b	1281011000		
AC200V, AC220V	50Hz, 60Hz	1a1b	1281011100		
AC240V, AC277V	50Hz, 60Hz	1a1b	1281011200		
DC12V		1a1b	1281011300		
DC20V		1a1b	1281011400		
DC24V		1a1b	1281011500		
DC48V		1a1b	1281011600		
DC60V		1a1b	1281011700		
DC80V		1a1b	1281011800		
DC100V		1a1b	1281011900		
DC110V		1a1b	1281012000		
DC125V		1a1b	1281012100		
DC200V		1a1b	1281012200		
DC220V		1a1b	1281012300		
DC250V		1a1b	1281012400		

Catalogue numbers

Susol

Contactors

MC-50 lug type 1a1b



63AF

Model	Terminal type	Coil voltage	Frequency	Aux.contact	Code
MC-50	Lug	AC24V	50/60Hz	1a1b	1282006300
		AC48V	50/60Hz	1a1b	1282006400
		AC100V	50/60Hz	1a1b	1282006500
		AC110V	50/60Hz	1a1b	1282006600
		AC120V	50/60Hz	1a1b	1282006700
		AC200V	50/60Hz	1a1b	1282006800
		AC220V	50/60Hz	1a1b	1282006900
		AC230V	50/60Hz	1a1b	1282007000
		AC240V	50/60Hz	1a1b	1282007100
		AC380V	50/60Hz	1a1b	1282007200
		AC400V	50/60Hz	1a1b	1282007300
		AC415V	50/60Hz	1a1b	1282007400
		AC440V	50/60Hz	1a1b	1282007500
		AC500V	50/60Hz	1a1b	1282007600
		AC550V	50/60Hz	1a1b	1282007700
		AC24V	50Hz	1a1b	1282007800
		AC36V	50Hz	1a1b	1282007900
		AC42V	50Hz	1a1b	1282008000
		AC48V	50Hz	1a1b	1282008100
		AC80V	50Hz	1a1b	1282008200
		AC100V	50Hz	1a1b	1282008300
		AC110V	50Hz	1a1b	1282008400
		AC220V	50Hz	1a1b	1282008500
		AC230V	50Hz	1a1b	1282008600
		AC240V	50Hz	1a1b	1282008700
		AC380V	50Hz	1a1b	1282008800
		AC400V	50Hz	1a1b	1282008900
		AC415V	50Hz	1a1b	1282009000
		AC440V	50Hz	1a1b	1282009100
		AC500V	50Hz	1a1b	1282009200
		AC550V	50Hz	1a1b	1282009300
		AC24V	60Hz	1a1b	1282009400
		AC48V	60Hz	1a1b	1282009500
		AC100V	60Hz	1a1b	1282009600
		AC110V	60Hz	1a1b	1282009700
		AC120V	60Hz	1a1b	1282009800
		AC200V	60Hz	1a1b	1282009900
		AC208V	60Hz	1a1b	1282010000
		AC220V	60Hz	1a1b	1282010100
		AC230V	60Hz	1a1b	1282010200
		AC240V	60Hz	1a1b	1282010300
		AC277V	60Hz	1a1b	1282010400
AC380V	60Hz	1a1b	1282010500		
AC440V	60Hz	1a1b	1282010600		
AC480V	60Hz	1a1b	1282010700		
AC600V	60Hz	1a1b	1282010800		
AC100V, AC110V	50Hz, 60Hz	1a1b	1282010900		
AC110V, AC120V	50Hz, 60Hz	1a1b	1282011000		
AC200V, AC220V	50Hz, 60Hz	1a1b	1282011100		
AC240V, AC277V	50Hz, 60Hz	1a1b	1282011200		
DC12V		1a1b	1282011300		
DC20V		1a1b	1282011400		
DC24V		1a1b	1282011500		
DC48V		1a1b	1282011600		
DC60V		1a1b	1282011700		
DC80V		1a1b	1282011800		
DC100V		1a1b	1282011900		
DC110V		1a1b	1282012000		
DC125V		1a1b	1282012100		
DC200V		1a1b	1282012200		
DC220V		1a1b	1282012300		
DC250V		1a1b	1282012400		

Catalogue numbers

Susol

Contactors

MC-63 lug type 1a1b



63AF

Model	Terminal type	Coil voltage	Frequency	Aux.contact	Code
MC-63	Lug	AC24V	50/60Hz	1a1b	1283006300
		AC48V	50/60Hz	1a1b	1283006400
		AC100V	50/60Hz	1a1b	1283006500
		AC110V	50/60Hz	1a1b	1283006600
		AC120V	50/60Hz	1a1b	1283006700
		AC200V	50/60Hz	1a1b	1283006800
		AC220V	50/60Hz	1a1b	1283006900
		AC230V	50/60Hz	1a1b	1283007000
		AC240V	50/60Hz	1a1b	1283007100
		AC380V	50/60Hz	1a1b	1283007200
		AC400V	50/60Hz	1a1b	1283007300
		AC415V	50/60Hz	1a1b	1283007400
		AC440V	50/60Hz	1a1b	1283007500
		AC500V	50/60Hz	1a1b	1283007600
		AC550V	50/60Hz	1a1b	1283007700
		AC24V	50Hz	1a1b	1283007800
		AC36V	50Hz	1a1b	1283007900
		AC42V	50Hz	1a1b	1283008000
		AC48V	50Hz	1a1b	1283008100
		AC80V	50Hz	1a1b	1283008200
		AC100V	50Hz	1a1b	1283008300
		AC110V	50Hz	1a1b	1283008400
		AC220V	50Hz	1a1b	1283008500
		AC230V	50Hz	1a1b	1283008600
		AC240V	50Hz	1a1b	1283008700
		AC380V	50Hz	1a1b	1283008800
		AC400V	50Hz	1a1b	1283008900
		AC415V	50Hz	1a1b	1283009000
		AC440V	50Hz	1a1b	1283009100
		AC500V	50Hz	1a1b	1283009200
		AC550V	50Hz	1a1b	1283009300
		AC24V	60Hz	1a1b	1283009400
		AC48V	60Hz	1a1b	1283009500
		AC100V	60Hz	1a1b	1283009600
		AC110V	60Hz	1a1b	1283009700
		AC120V	60Hz	1a1b	1283009800
		AC200V	60Hz	1a1b	1283009900
		AC208V	60Hz	1a1b	1283010000
		AC220V	60Hz	1a1b	1283010100
		AC230V	60Hz	1a1b	1283010200
		AC240V	60Hz	1a1b	1283010300
		AC277V	60Hz	1a1b	1283010400
		AC380V	60Hz	1a1b	1283010500
		AC440V	60Hz	1a1b	1283010600
		AC480V	60Hz	1a1b	1283010700
AC600V	60Hz	1a1b	1283010800		
AC100V, AC110V	50Hz, 60Hz	1a1b	1283010900		
AC110V, AC120V	50Hz, 60Hz	1a1b	1283011000		
AC200V, AC220V	50Hz, 60Hz	1a1b	1283011100		
AC240V, AC277V	50Hz, 60Hz	1a1b	1283011200		
DC12V		1a1b	1283011300		
DC20V		1a1b	1283011400		
DC24V		1a1b	1283011500		
DC48V		1a1b	1283011600		
DC60V		1a1b	1283011700		
DC80V		1a1b	1283011800		
DC100V		1a1b	1283011900		
DC110V		1a1b	1283012000		
DC125V		1a1b	1283012100		
DC200V		1a1b	1283012200		
DC220V		1a1b	1283012300		
DC250V		1a1b	1283012400		

Catalogue numbers

Susol

Contactors

MC-65 lug type 1a1b



95AF

Model	Terminal type	Coil voltage	Frequency	Aux.contact	Code
MC-65	Lug	AC24V	50/60Hz	1a1b	1284006300
		AC48V	50/60Hz	1a1b	1284006400
		AC100V	50/60Hz	1a1b	1284006500
		AC110V	50/60Hz	1a1b	1284006600
		AC120V	50/60Hz	1a1b	1284006700
		AC200V	50/60Hz	1a1b	1284006800
		AC220V	50/60Hz	1a1b	1284006900
		AC230V	50/60Hz	1a1b	1284007000
		AC240V	50/60Hz	1a1b	1284007100
		AC380V	50/60Hz	1a1b	1284007200
		AC400V	50/60Hz	1a1b	1284007300
		AC415V	50/60Hz	1a1b	1284007400
		AC440V	50/60Hz	1a1b	1284007500
		AC500V	50/60Hz	1a1b	1284007600
		AC550V	50/60Hz	1a1b	1284007700
		AC24V	50Hz	1a1b	1284007800
		AC36V	50Hz	1a1b	1284007900
		AC42V	50Hz	1a1b	1284008000
		AC48V	50Hz	1a1b	1284008100
		AC80V	50Hz	1a1b	1284008200
		AC100V	50Hz	1a1b	1284008300
		AC110V	50Hz	1a1b	1284008400
		AC220V	50Hz	1a1b	1284008500
		AC230V	50Hz	1a1b	1284008600
		AC240V	50Hz	1a1b	1284008700
		AC380V	50Hz	1a1b	1284008800
		AC400V	50Hz	1a1b	1284008900
		AC415V	50Hz	1a1b	1284009000
		AC440V	50Hz	1a1b	1284009100
		AC500V	50Hz	1a1b	1284009200
		AC550V	50Hz	1a1b	1284009300
		AC24V	60Hz	1a1b	1284009400
		AC48V	60Hz	1a1b	1284009500
		AC100V	60Hz	1a1b	1284009600
		AC110V	60Hz	1a1b	1284009700
		AC120V	60Hz	1a1b	1284009800
		AC200V	60Hz	1a1b	1284009900
		AC208V	60Hz	1a1b	1284010000
		AC220V	60Hz	1a1b	1284010100
		AC230V	60Hz	1a1b	1284010200
		AC240V	60Hz	1a1b	1284010300
		AC277V	60Hz	1a1b	1284010400
		AC380V	60Hz	1a1b	1284010500
		AC440V	60Hz	1a1b	1284010600
		AC480V	60Hz	1a1b	1284010700
		AC600V	60Hz	1a1b	1284010800
AC100V, AC110V	50Hz, 60Hz	1a1b	1284010900		
AC110V, AC120V	50Hz, 60Hz	1a1b	1284011000		
AC200V, AC220V	50Hz, 60Hz	1a1b	1284011100		
AC240V, AC277V	50Hz, 60Hz	1a1b	1284011200		
DC12V		1a1b	1284011300		
DC20V		1a1b	1284011400		
DC24V		1a1b	1284011500		
DC48V		1a1b	1284011600		
DC60V		1a1b	1284011700		
DC80V		1a1b	1284011800		
DC100V		1a1b	1284011900		
DC110V		1a1b	1284012000		
DC125V		1a1b	1284012100		
DC200V		1a1b	1284012200		
DC220V		1a1b	1284012300		
DC250V		1a1b	1284012400		

Catalogue numbers

Susol

Contactors

MC-75 lug type 1a1b



95AF

Model	Terminal type	Coil voltage	Frequency	Aux.contact	Code
MC-75	Lug	AC24V	50/60Hz	1a1b	1285006300
		AC48V	50/60Hz	1a1b	1285006400
		AC100V	50/60Hz	1a1b	1285006500
		AC110V	50/60Hz	1a1b	1285006600
		AC120V	50/60Hz	1a1b	1285006700
		AC200V	50/60Hz	1a1b	1285006800
		AC220V	50/60Hz	1a1b	1285006900
		AC230V	50/60Hz	1a1b	1285007000
		AC240V	50/60Hz	1a1b	1285007100
		AC380V	50/60Hz	1a1b	1285007200
		AC400V	50/60Hz	1a1b	1285007300
		AC415V	50/60Hz	1a1b	1285007400
		AC440V	50/60Hz	1a1b	1285007500
		AC500V	50/60Hz	1a1b	1285007600
		AC550V	50/60Hz	1a1b	1285007700
		AC24V	50Hz	1a1b	1285007800
		AC36V	50Hz	1a1b	1285007900
		AC42V	50Hz	1a1b	1285008000
		AC48V	50Hz	1a1b	1285008100
		AC80V	50Hz	1a1b	1285008200
		AC100V	50Hz	1a1b	1285008300
		AC110V	50Hz	1a1b	1285008400
		AC220V	50Hz	1a1b	1285008500
		AC230V	50Hz	1a1b	1285008600
		AC240V	50Hz	1a1b	1285008700
		AC380V	50Hz	1a1b	1285008800
		AC400V	50Hz	1a1b	1285008900
		AC415V	50Hz	1a1b	1285009000
		AC440V	50Hz	1a1b	1285009100
		AC500V	50Hz	1a1b	1285009200
		AC550V	50Hz	1a1b	1285009300
		AC24V	60Hz	1a1b	1285009400
		AC48V	60Hz	1a1b	1285009500
		AC100V	60Hz	1a1b	1285009600
		AC110V	60Hz	1a1b	1285009700
		AC120V	60Hz	1a1b	1285009800
		AC200V	60Hz	1a1b	1285009900
		AC208V	60Hz	1a1b	1285010000
		AC220V	60Hz	1a1b	1285010100
		AC230V	60Hz	1a1b	1285010200
		AC240V	60Hz	1a1b	1285010300
		AC277V	60Hz	1a1b	1285010400
AC380V	60Hz	1a1b	1285010500		
AC440V	60Hz	1a1b	1285010600		
AC480V	60Hz	1a1b	1285010700		
AC600V	60Hz	1a1b	1285010800		
AC100V, AC110V	50Hz, 60Hz	1a1b	1285010900		
AC110V, AC120V	50Hz, 60Hz	1a1b	1285011000		
AC200V, AC220V	50Hz, 60Hz	1a1b	1285011100		
AC240V, AC277V	50Hz, 60Hz	1a1b	1285011200		
DC12V		1a1b	1285011300		
DC20V		1a1b	1285011400		
DC24V		1a1b	1285011500		
DC48V		1a1b	1285011600		
DC60V		1a1b	1285011700		
DC80V		1a1b	1285011800		
DC100V		1a1b	1285011900		
DC110V		1a1b	1285012000		
DC125V		1a1b	1285012100		
DC200V		1a1b	1285012200		
DC220V		1a1b	1285012300		
DC250V		1a1b	1285012400		

Catalogue numbers

Susol

Contactors

MC-85 lug type 1a1b



95AF

Model	Terminal type	Coil voltage	Frequency	Aux.contact	Code
MC-85	Lug	AC24V	50/60Hz	1a1b	1286006300
		AC48V	50/60Hz	1a1b	1286006400
		AC100V	50/60Hz	1a1b	1286006500
		AC110V	50/60Hz	1a1b	1286006600
		AC120V	50/60Hz	1a1b	1286006700
		AC200V	50/60Hz	1a1b	1286006800
		AC220V	50/60Hz	1a1b	1286006900
		AC230V	50/60Hz	1a1b	1286007000
		AC240V	50/60Hz	1a1b	1286007100
		AC380V	50/60Hz	1a1b	1286007200
		AC400V	50/60Hz	1a1b	1286007300
		AC415V	50/60Hz	1a1b	1286007400
		AC440V	50/60Hz	1a1b	1286007500
		AC500V	50/60Hz	1a1b	1286007600
		AC550V	50/60Hz	1a1b	1286007700
		AC24V	50Hz	1a1b	1286007800
		AC36V	50Hz	1a1b	1286007900
		AC42V	50Hz	1a1b	1286008000
		AC48V	50Hz	1a1b	1286008100
		AC80V	50Hz	1a1b	1286008200
		AC100V	50Hz	1a1b	1286008300
		AC110V	50Hz	1a1b	1286008400
		AC220V	50Hz	1a1b	1286008500
		AC230V	50Hz	1a1b	1286008600
		AC240V	50Hz	1a1b	1286008700
		AC380V	50Hz	1a1b	1286008800
		AC400V	50Hz	1a1b	1286008900
		AC415V	50Hz	1a1b	1286009000
		AC440V	50Hz	1a1b	1286009100
		AC500V	50Hz	1a1b	1286009200
		AC550V	50Hz	1a1b	1286009300
		AC24V	60Hz	1a1b	1286009400
		AC48V	60Hz	1a1b	1286009500
		AC100V	60Hz	1a1b	1286009600
		AC110V	60Hz	1a1b	1286009700
		AC120V	60Hz	1a1b	1286009800
		AC200V	60Hz	1a1b	1286009900
		AC208V	60Hz	1a1b	1286010000
		AC220V	60Hz	1a1b	1286010100
		AC230V	60Hz	1a1b	1286010200
		AC240V	60Hz	1a1b	1286010300
		AC277V	60Hz	1a1b	1286010400
		AC380V	60Hz	1a1b	1286010500
		AC440V	60Hz	1a1b	1286010600
		AC480V	60Hz	1a1b	1286010700
AC600V	60Hz	1a1b	1286010800		
AC100V, AC110V	50Hz, 60Hz	1a1b	1286010900		
AC110V, AC120V	50Hz, 60Hz	1a1b	1286011000		
AC200V, AC220V	50Hz, 60Hz	1a1b	1286011100		
AC240V, AC277V	50Hz, 60Hz	1a1b	1286011200		
DC12V		1a1b	1286011300		
DC20V		1a1b	1286011400		
DC24V		1a1b	1286011500		
DC48V		1a1b	1286011600		
DC60V		1a1b	1286011700		
DC80V		1a1b	1286011800		
DC100V		1a1b	1286011900		
DC110V		1a1b	1286012000		
DC125V		1a1b	1286012100		
DC200V		1a1b	1286012200		
DC220V		1a1b	1286012300		
DC250V		1a1b	1286012400		

Catalogue numbers

Susol

Contactors

MC-95 lug type 1a1b



95AF

Model	Terminal type	Coil voltage	Frequency	Aux.contact	Code
MC-95	Lug	AC24V	50/60Hz	1a1b	1287006300
		AC48V	50/60Hz	1a1b	1287006400
		AC100V	50/60Hz	1a1b	1287006500
		AC110V	50/60Hz	1a1b	1287006600
		AC120V	50/60Hz	1a1b	1287006700
		AC200V	50/60Hz	1a1b	1287006800
		AC220V	50/60Hz	1a1b	1287006900
		AC230V	50/60Hz	1a1b	1287007000
		AC240V	50/60Hz	1a1b	1287007100
		AC380V	50/60Hz	1a1b	1287007200
		AC400V	50/60Hz	1a1b	1287007300
		AC415V	50/60Hz	1a1b	1287007400
		AC440V	50/60Hz	1a1b	1287007500
		AC500V	50/60Hz	1a1b	1287007600
		AC550V	50/60Hz	1a1b	1287007700
		AC24V	50Hz	1a1b	1287007800
		AC36V	50Hz	1a1b	1287007900
		AC42V	50Hz	1a1b	1287008000
		AC48V	50Hz	1a1b	1287008100
		AC80V	50Hz	1a1b	1287008200
		AC100V	50Hz	1a1b	1287008300
		AC110V	50Hz	1a1b	1287008400
		AC220V	50Hz	1a1b	1287008500
		AC230V	50Hz	1a1b	1287008600
		AC240V	50Hz	1a1b	1287008700
		AC380V	50Hz	1a1b	1287008800
		AC400V	50Hz	1a1b	1287008900
		AC415V	50Hz	1a1b	1287009000
		AC440V	50Hz	1a1b	1287009100
		AC500V	50Hz	1a1b	1287009200
		AC550V	50Hz	1a1b	1287009300
		AC24V	60Hz	1a1b	1287009400
		AC48V	60Hz	1a1b	1287009500
		AC100V	60Hz	1a1b	1287009600
		AC110V	60Hz	1a1b	1287009700
		AC120V	60Hz	1a1b	1287009800
		AC200V	60Hz	1a1b	1287009900
		AC208V	60Hz	1a1b	1287010000
		AC220V	60Hz	1a1b	1287010100
		AC230V	60Hz	1a1b	1287010200
		AC240V	60Hz	1a1b	1287010300
		AC277V	60Hz	1a1b	1287010400
		AC380V	60Hz	1a1b	1287010500
		AC440V	60Hz	1a1b	1287010600
		AC480V	60Hz	1a1b	1287010700
AC600V	60Hz	1a1b	1287010800		
AC100V, AC110V	50Hz, 60Hz	1a1b	1287010900		
AC110V, AC120V	50Hz, 60Hz	1a1b	1287011000		
AC200V, AC220V	50Hz, 60Hz	1a1b	1287011100		
AC240V, AC277V	50Hz, 60Hz	1a1b	1287011200		
DC12V		1a1b	1287011300		
DC20V		1a1b	1287011400		
DC24V		1a1b	1287011500		
DC48V		1a1b	1287011600		
DC60V		1a1b	1287011700		
DC80V		1a1b	1287011800		
DC100V		1a1b	1287011900		
DC110V		1a1b	1287012000		
DC125V		1a1b	1287012100		
DC200V		1a1b	1287012200		
DC220V		1a1b	1287012300		
DC250V		1a1b	1287012400		

Catalogue numbers

Susol

Contactors

MC-35 screw type 1a1b



63AF

Model	Terminal type	Coil voltage	Frequency	Aux.contact	Code
MC-35	Screw	AC24V	50/60Hz	1a1b	1288006300
		AC48V	50/60Hz	1a1b	1288006400
		AC100V	50/60Hz	1a1b	1288006500
		AC110V	50/60Hz	1a1b	1288006600
		AC120V	50/60Hz	1a1b	1288006700
		AC200V	50/60Hz	1a1b	1288006800
		AC220V	50/60Hz	1a1b	1288006900
		AC230V	50/60Hz	1a1b	1288007000
		AC240V	50/60Hz	1a1b	1288007100
		AC380V	50/60Hz	1a1b	1288007200
		AC400V	50/60Hz	1a1b	1288007300
		AC415V	50/60Hz	1a1b	1288007400
		AC440V	50/60Hz	1a1b	1288007500
		AC500V	50/60Hz	1a1b	1288007600
		AC550V	50/60Hz	1a1b	1288007700
		AC24V	50Hz	1a1b	1288007800
		AC36V	50Hz	1a1b	1288007900
		AC42V	50Hz	1a1b	1288008000
		AC48V	50Hz	1a1b	1288008100
		AC80V	50Hz	1a1b	1288008200
		AC100V	50Hz	1a1b	1288008300
		AC110V	50Hz	1a1b	1288008400
		AC220V	50Hz	1a1b	1288008500
		AC230V	50Hz	1a1b	1288008600
		AC240V	50Hz	1a1b	1288008700
		AC380V	50Hz	1a1b	1288008800
		AC400V	50Hz	1a1b	1288008900
		AC415V	50Hz	1a1b	1288009000
		AC440V	50Hz	1a1b	1288009100
		AC500V	50Hz	1a1b	1288009200
		AC550V	50Hz	1a1b	1288009300
		AC24V	60Hz	1a1b	1288009400
		AC48V	60Hz	1a1b	1288009500
		AC100V	60Hz	1a1b	1288009600
		AC110V	60Hz	1a1b	1288009700
		AC120V	60Hz	1a1b	1288009800
		AC200V	60Hz	1a1b	1288009900
		AC208V	60Hz	1a1b	1288010000
		AC220V	60Hz	1a1b	1288010100
		AC230V	60Hz	1a1b	1288010200
		AC240V	60Hz	1a1b	1288010300
		AC277V	60Hz	1a1b	1288010400
		AC380V	60Hz	1a1b	1288010500
		AC440V	60Hz	1a1b	1288010600
		AC480V	60Hz	1a1b	1288010700
		AC600V	60Hz	1a1b	1288010800
		AC100V, AC110V	50Hz, 60Hz	1a1b	1288010900
		AC110V, AC120V	50Hz, 60Hz	1a1b	1288011000
		AC200V, AC220V	50Hz, 60Hz	1a1b	1288011100
		AC240V, AC277V	50Hz, 60Hz	1a1b	1288011200
DC12V		1a1b	1288011300		
DC20V		1a1b	1288011400		
DC24V		1a1b	1288011500		
DC48V		1a1b	1288011600		
DC60V		1a1b	1288011700		
DC80V		1a1b	1288011800		
DC100V		1a1b	1288011900		
DC110V		1a1b	1288012000		
DC125V		1a1b	1288012100		
DC200V		1a1b	1288012200		
DC220V		1a1b	1288012300		
DC250V		1a1b	1288012400		

Catalogue numbers

Susol

Contactors

MC-40 screw type 1a1b



63AF

Model	Terminal type	Coil voltage	Frequency	Aux.contact	Code
MC-40	Screw	AC24V	50/60Hz	1a1b	1289006300
		AC48V	50/60Hz	1a1b	1289006400
		AC100V	50/60Hz	1a1b	1289006500
		AC110V	50/60Hz	1a1b	1289006600
		AC120V	50/60Hz	1a1b	1289006700
		AC200V	50/60Hz	1a1b	1289006800
		AC220V	50/60Hz	1a1b	1289006900
		AC230V	50/60Hz	1a1b	1289007000
		AC240V	50/60Hz	1a1b	1289007100
		AC380V	50/60Hz	1a1b	1289007200
		AC400V	50/60Hz	1a1b	1289007300
		AC415V	50/60Hz	1a1b	1289007400
		AC440V	50/60Hz	1a1b	1289007500
		AC500V	50/60Hz	1a1b	1289007600
		AC550V	50/60Hz	1a1b	1289007700
		AC24V	50Hz	1a1b	1289007800
		AC36V	50Hz	1a1b	1289007900
		AC42V	50Hz	1a1b	1289008000
		AC48V	50Hz	1a1b	1289008100
		AC80V	50Hz	1a1b	1289008200
		AC100V	50Hz	1a1b	1289008300
		AC110V	50Hz	1a1b	1289008400
		AC220V	50Hz	1a1b	1289008500
		AC230V	50Hz	1a1b	1289008600
		AC240V	50Hz	1a1b	1289008700
		AC380V	50Hz	1a1b	1289008800
		AC400V	50Hz	1a1b	1289008900
		AC415V	50Hz	1a1b	1289009000
		AC440V	50Hz	1a1b	1289009100
		AC500V	50Hz	1a1b	1289009200
		AC550V	50Hz	1a1b	1289009300
		AC24V	60Hz	1a1b	1289009400
		AC48V	60Hz	1a1b	1289009500
		AC100V	60Hz	1a1b	1289009600
		AC110V	60Hz	1a1b	1289009700
		AC120V	60Hz	1a1b	1289009800
		AC200V	60Hz	1a1b	1289009900
		AC208V	60Hz	1a1b	1289010000
		AC220V	60Hz	1a1b	1289010100
		AC230V	60Hz	1a1b	1289010200
		AC240V	60Hz	1a1b	1289010300
		AC277V	60Hz	1a1b	1289010400
		AC380V	60Hz	1a1b	1289010500
		AC440V	60Hz	1a1b	1289010600
		AC480V	60Hz	1a1b	1289010700
		AC600V	60Hz	1a1b	1289010800
AC100V, AC110V	50Hz, 60Hz	1a1b	1289010900		
AC110V, AC120V	50Hz, 60Hz	1a1b	1289011000		
AC200V, AC220V	50Hz, 60Hz	1a1b	1289011100		
AC240V, AC277V	50Hz, 60Hz	1a1b	1289011200		
DC12V		1a1b	1289011300		
DC20V		1a1b	1289011400		
DC24V		1a1b	1289011500		
DC48V		1a1b	1289011600		
DC60V		1a1b	1289011700		
DC80V		1a1b	1289011800		
DC100V		1a1b	1289011900		
DC110V		1a1b	1289012000		
DC125V		1a1b	1289012100		
DC200V		1a1b	1289012200		
DC220V		1a1b	1289012300		
DC250V		1a1b	1289012400		

Catalogue numbers

Susol

Contactors

MC-50 screw type 1a1b



63AF

Model	Terminal type	Coil voltage	Frequency	Aux.contact	Code
MC-50	Screw	AC24V	50/60Hz	1a1b	1290006300
		AC48V	50/60Hz	1a1b	1290006400
		AC100V	50/60Hz	1a1b	1290006500
		AC110V	50/60Hz	1a1b	1290006600
		AC120V	50/60Hz	1a1b	1290006700
		AC200V	50/60Hz	1a1b	1290006800
		AC220V	50/60Hz	1a1b	1290006900
		AC230V	50/60Hz	1a1b	1290007000
		AC240V	50/60Hz	1a1b	1290007100
		AC380V	50/60Hz	1a1b	1290007200
		AC400V	50/60Hz	1a1b	1290007300
		AC415V	50/60Hz	1a1b	1290007400
		AC440V	50/60Hz	1a1b	1290007500
		AC500V	50/60Hz	1a1b	1290007600
		AC550V	50/60Hz	1a1b	1290007700
		AC24V	50Hz	1a1b	1290007800
		AC36V	50Hz	1a1b	1290007900
		AC42V	50Hz	1a1b	1290008000
		AC48V	50Hz	1a1b	1290008100
		AC80V	50Hz	1a1b	1290008200
		AC100V	50Hz	1a1b	1290008300
		AC110V	50Hz	1a1b	1290008400
		AC220V	50Hz	1a1b	1290008500
		AC230V	50Hz	1a1b	1290008600
		AC240V	50Hz	1a1b	1290008700
		AC380V	50Hz	1a1b	1290008800
		AC400V	50Hz	1a1b	1290008900
		AC415V	50Hz	1a1b	1290009000
		AC440V	50Hz	1a1b	1290009100
		AC500V	50Hz	1a1b	1290009200
		AC550V	50Hz	1a1b	1290009300
		AC24V	60Hz	1a1b	1290009400
		AC48V	60Hz	1a1b	1290009500
		AC100V	60Hz	1a1b	1290009600
		AC110V	60Hz	1a1b	1290009700
		AC120V	60Hz	1a1b	1290009800
		AC200V	60Hz	1a1b	1290009900
		AC208V	60Hz	1a1b	1290010000
		AC220V	60Hz	1a1b	1290010100
		AC230V	60Hz	1a1b	1290010200
		AC240V	60Hz	1a1b	1290010300
		AC277V	60Hz	1a1b	1290010400
AC380V	60Hz	1a1b	1290010500		
AC440V	60Hz	1a1b	1290010600		
AC480V	60Hz	1a1b	1290010700		
AC600V	60Hz	1a1b	1290010800		
AC100V, AC110V	50Hz, 60Hz	1a1b	1290010900		
AC110V, AC120V	50Hz, 60Hz	1a1b	1290011000		
AC200V, AC220V	50Hz, 60Hz	1a1b	1290011100		
AC240V, AC277V	50Hz, 60Hz	1a1b	1290011200		
DC12V		1a1b	1290011300		
DC20V		1a1b	1290011400		
DC24V		1a1b	1290011500		
DC48V		1a1b	1290011600		
DC60V		1a1b	1290011700		
DC80V		1a1b	1290011800		
DC100V		1a1b	1290011900		
DC110V		1a1b	1290012000		
DC125V		1a1b	1290012100		
DC200V		1a1b	1290012200		
DC220V		1a1b	1290012300		
DC250V		1a1b	1290012400		

Catalogue numbers

Susol

Contactors

MC-63 screw type 1a1b



63AF

Model	Terminal type	Coil voltage	Frequency	Aux.contact	Code
MC-63	Screw	AC24V	50/60Hz	1a1b	1291006300
		AC48V	50/60Hz	1a1b	1291006400
		AC100V	50/60Hz	1a1b	1291006500
		AC110V	50/60Hz	1a1b	1291006600
		AC120V	50/60Hz	1a1b	1291006700
		AC200V	50/60Hz	1a1b	1291006800
		AC220V	50/60Hz	1a1b	1291006900
		AC230V	50/60Hz	1a1b	1291007000
		AC240V	50/60Hz	1a1b	1291007100
		AC380V	50/60Hz	1a1b	1291007200
		AC400V	50/60Hz	1a1b	1291007300
		AC415V	50/60Hz	1a1b	1291007400
		AC440V	50/60Hz	1a1b	1291007500
		AC500V	50/60Hz	1a1b	1291007600
		AC550V	50/60Hz	1a1b	1291007700
		AC24V	50Hz	1a1b	1291007800
		AC36V	50Hz	1a1b	1291007900
		AC42V	50Hz	1a1b	1291008000
		AC48V	50Hz	1a1b	1291008100
		AC80V	50Hz	1a1b	1291008200
		AC100V	50Hz	1a1b	1291008300
		AC110V	50Hz	1a1b	1291008400
		AC220V	50Hz	1a1b	1291008500
		AC230V	50Hz	1a1b	1291008600
		AC240V	50Hz	1a1b	1291008700
		AC380V	50Hz	1a1b	1291008800
		AC400V	50Hz	1a1b	1291008900
		AC415V	50Hz	1a1b	1291009000
		AC440V	50Hz	1a1b	1291009100
		AC500V	50Hz	1a1b	1291009200
		AC550V	50Hz	1a1b	1291009300
		AC24V	60Hz	1a1b	1291009400
		AC48V	60Hz	1a1b	1291009500
		AC100V	60Hz	1a1b	1291009600
		AC110V	60Hz	1a1b	1291009700
		AC120V	60Hz	1a1b	1291009800
		AC200V	60Hz	1a1b	1291009900
		AC208V	60Hz	1a1b	1291010000
		AC220V	60Hz	1a1b	1291010100
		AC230V	60Hz	1a1b	1291010200
		AC240V	60Hz	1a1b	1291010300
		AC277V	60Hz	1a1b	1291010400
		AC380V	60Hz	1a1b	1291010500
		AC440V	60Hz	1a1b	1291010600
		AC480V	60Hz	1a1b	1291010700
		AC600V	60Hz	1a1b	1291010800
		AC100V, AC110V	50Hz, 60Hz	1a1b	1291010900
		AC110V, AC120V	50Hz, 60Hz	1a1b	1291011000
		AC200V, AC220V	50Hz, 60Hz	1a1b	1291011100
		AC240V, AC277V	50Hz, 60Hz	1a1b	1291011200
DC12V		1a1b	1291011300		
DC20V		1a1b	1291011400		
DC24V		1a1b	1291011500		
DC48V		1a1b	1291011600		
DC60V		1a1b	1291011700		
DC80V		1a1b	1291011800		
DC100V		1a1b	1291011900		
DC110V		1a1b	1291012000		
DC125V		1a1b	1291012100		
DC200V		1a1b	1291012200		
DC220V		1a1b	1291012300		
DC250V		1a1b	1291012400		

Catalogue numbers

Susol

Contactors

MC-65 screw type 1a1b



95AF

Model	Terminal type	Coil voltage	Frequency	Aux.contact	Code
MC-65	Screw	AC24V	50/60Hz	1a1b	1292006300
		AC48V	50/60Hz	1a1b	1292006400
		AC100V	50/60Hz	1a1b	1292006500
		AC110V	50/60Hz	1a1b	1292006600
		AC120V	50/60Hz	1a1b	1292006700
		AC200V	50/60Hz	1a1b	1292006800
		AC220V	50/60Hz	1a1b	1292006900
		AC230V	50/60Hz	1a1b	1292007000
		AC240V	50/60Hz	1a1b	1292007100
		AC380V	50/60Hz	1a1b	1292007200
		AC400V	50/60Hz	1a1b	1292007300
		AC415V	50/60Hz	1a1b	1292007400
		AC440V	50/60Hz	1a1b	1292007500
		AC500V	50/60Hz	1a1b	1292007600
		AC550V	50/60Hz	1a1b	1292007700
		AC24V	50Hz	1a1b	1292007800
		AC36V	50Hz	1a1b	1292007900
		AC42V	50Hz	1a1b	1292008000
		AC48V	50Hz	1a1b	1292008100
		AC80V	50Hz	1a1b	1292008200
		AC100V	50Hz	1a1b	1292008300
		AC110V	50Hz	1a1b	1292008400
		AC220V	50Hz	1a1b	1292008500
		AC230V	50Hz	1a1b	1292008600
		AC240V	50Hz	1a1b	1292008700
		AC380V	50Hz	1a1b	1292008800
		AC400V	50Hz	1a1b	1292008900
		AC415V	50Hz	1a1b	1292009000
		AC440V	50Hz	1a1b	1292009100
		AC500V	50Hz	1a1b	1292009200
		AC550V	50Hz	1a1b	1292009300
		AC24V	60Hz	1a1b	1292009400
		AC48V	60Hz	1a1b	1292009500
		AC100V	60Hz	1a1b	1292009600
		AC110V	60Hz	1a1b	1292009700
		AC120V	60Hz	1a1b	1292009800
		AC200V	60Hz	1a1b	1292009900
		AC208V	60Hz	1a1b	1292010000
		AC220V	60Hz	1a1b	1292010100
		AC230V	60Hz	1a1b	1292010200
		AC240V	60Hz	1a1b	1292010300
		AC277V	60Hz	1a1b	1292010400
		AC380V	60Hz	1a1b	1292010500
		AC440V	60Hz	1a1b	1292010600
		AC480V	60Hz	1a1b	1292010700
		AC600V	60Hz	1a1b	1292010800
AC100V, AC110V	50Hz, 60Hz	1a1b	1292010900		
AC110V, AC120V	50Hz, 60Hz	1a1b	1292011000		
AC200V, AC220V	50Hz, 60Hz	1a1b	1292011100		
AC240V, AC277V	50Hz, 60Hz	1a1b	1292011200		
DC12V		1a1b	1292011300		
DC20V		1a1b	1292011400		
DC24V		1a1b	1292011500		
DC48V		1a1b	1292011600		
DC60V		1a1b	1292011700		
DC80V		1a1b	1292011800		
DC100V		1a1b	1292011900		
DC110V		1a1b	1292012000		
DC125V		1a1b	1292012100		
DC200V		1a1b	1292012200		
DC220V		1a1b	1292012300		
DC250V		1a1b	1292012400		

Catalogue numbers

Susol

Contactors

MC-75 screw type 1a1b



95AF

Model	Terminal type	Coil voltage	Frequency	Aux.contact	Code
MC-75	Screw	AC24V	50/60Hz	1a1b	1293006300
		AC48V	50/60Hz	1a1b	1293006400
		AC100V	50/60Hz	1a1b	1293006500
		AC110V	50/60Hz	1a1b	1293006600
		AC120V	50/60Hz	1a1b	1293006700
		AC200V	50/60Hz	1a1b	1293006800
		AC220V	50/60Hz	1a1b	1293006900
		AC230V	50/60Hz	1a1b	1293007000
		AC240V	50/60Hz	1a1b	1293007100
		AC380V	50/60Hz	1a1b	1293007200
		AC400V	50/60Hz	1a1b	1293007300
		AC415V	50/60Hz	1a1b	1293007400
		AC440V	50/60Hz	1a1b	1293007500
		AC500V	50/60Hz	1a1b	1293007600
		AC550V	50/60Hz	1a1b	1293007700
		AC24V	50Hz	1a1b	1293007800
		AC36V	50Hz	1a1b	1293007900
		AC42V	50Hz	1a1b	1293008000
		AC48V	50Hz	1a1b	1293008100
		AC80V	50Hz	1a1b	1293008200
		AC100V	50Hz	1a1b	1293008300
		AC110V	50Hz	1a1b	1293008400
		AC220V	50Hz	1a1b	1293008500
		AC230V	50Hz	1a1b	1293008600
		AC240V	50Hz	1a1b	1293008700
		AC380V	50Hz	1a1b	1293008800
		AC400V	50Hz	1a1b	1293008900
		AC415V	50Hz	1a1b	1293009000
		AC440V	50Hz	1a1b	1293009100
		AC500V	50Hz	1a1b	1293009200
		AC550V	50Hz	1a1b	1293009300
		AC24V	60Hz	1a1b	1293009400
		AC48V	60Hz	1a1b	1293009500
		AC100V	60Hz	1a1b	1293009600
		AC110V	60Hz	1a1b	1293009700
		AC120V	60Hz	1a1b	1293009800
		AC200V	60Hz	1a1b	1293009900
		AC208V	60Hz	1a1b	1293010000
		AC220V	60Hz	1a1b	1293010100
		AC230V	60Hz	1a1b	1293010200
		AC240V	60Hz	1a1b	1293010300
		AC277V	60Hz	1a1b	1293010400
AC380V	60Hz	1a1b	1293010500		
AC440V	60Hz	1a1b	1293010600		
AC480V	60Hz	1a1b	1293010700		
AC600V	60Hz	1a1b	1293010800		
AC100V, AC110V	50Hz, 60Hz	1a1b	1293010900		
AC110V, AC120V	50Hz, 60Hz	1a1b	1293011000		
AC200V, AC220V	50Hz, 60Hz	1a1b	1293011100		
AC240V, AC277V	50Hz, 60Hz	1a1b	1293011200		
DC12V		1a1b	1293011300		
DC20V		1a1b	1293011400		
DC24V		1a1b	1293011500		
DC48V		1a1b	1293011600		
DC60V		1a1b	1293011700		
DC80V		1a1b	1293011800		
DC100V		1a1b	1293011900		
DC110V		1a1b	1293012000		
DC125V		1a1b	1293012100		
DC200V		1a1b	1293012200		
DC220V		1a1b	1293012300		
DC250V		1a1b	1293012400		

Catalogue numbers

Susol

Contactors

MC-85 screw type 1a1b



95AF

Model	Terminal type	Coil voltage	Frequency	Aux.contact	Code
MC-85	Screw	AC24V	50/60Hz	1a1b	1294006300
		AC48V	50/60Hz	1a1b	1294006400
		AC100V	50/60Hz	1a1b	1294006500
		AC110V	50/60Hz	1a1b	1294006600
		AC120V	50/60Hz	1a1b	1294006700
		AC200V	50/60Hz	1a1b	1294006800
		AC220V	50/60Hz	1a1b	1294006900
		AC230V	50/60Hz	1a1b	1294007000
		AC240V	50/60Hz	1a1b	1294007100
		AC380V	50/60Hz	1a1b	1294007200
		AC400V	50/60Hz	1a1b	1294007300
		AC415V	50/60Hz	1a1b	1294007400
		AC440V	50/60Hz	1a1b	1294007500
		AC500V	50/60Hz	1a1b	1294007600
		AC550V	50/60Hz	1a1b	1294007700
		AC24V	50Hz	1a1b	1294007800
		AC36V	50Hz	1a1b	1294007900
		AC42V	50Hz	1a1b	1294008000
		AC48V	50Hz	1a1b	1294008100
		AC80V	50Hz	1a1b	1294008200
		AC100V	50Hz	1a1b	1294008300
		AC110V	50Hz	1a1b	1294008400
		AC220V	50Hz	1a1b	1294008500
		AC230V	50Hz	1a1b	1294008600
		AC240V	50Hz	1a1b	1294008700
		AC380V	50Hz	1a1b	1294008800
		AC400V	50Hz	1a1b	1294008900
		AC415V	50Hz	1a1b	1294009000
		AC440V	50Hz	1a1b	1294009100
		AC500V	50Hz	1a1b	1294009200
		AC550V	50Hz	1a1b	1294009300
		AC24V	60Hz	1a1b	1294009400
		AC48V	60Hz	1a1b	1294009500
		AC100V	60Hz	1a1b	1294009600
		AC110V	60Hz	1a1b	1294009700
		AC120V	60Hz	1a1b	1294009800
		AC200V	60Hz	1a1b	1294009900
		AC208V	60Hz	1a1b	1294010000
		AC220V	60Hz	1a1b	1294010100
		AC230V	60Hz	1a1b	1294010200
		AC240V	60Hz	1a1b	1294010300
		AC277V	60Hz	1a1b	1294010400
		AC380V	60Hz	1a1b	1294010500
		AC440V	60Hz	1a1b	1294010600
		AC480V	60Hz	1a1b	1294010700
AC600V	60Hz	1a1b	1294010800		
AC100V, AC110V	50Hz, 60Hz	1a1b	1294010900		
AC110V, AC120V	50Hz, 60Hz	1a1b	1294011000		
AC200V, AC220V	50Hz, 60Hz	1a1b	1294011100		
AC240V, AC277V	50Hz, 60Hz	1a1b	1294011200		
DC12V		1a1b	1294011300		
DC20V		1a1b	1294011400		
DC24V		1a1b	1294011500		
DC48V		1a1b	1294011600		
DC60V		1a1b	1294011700		
DC80V		1a1b	1294011800		
DC100V		1a1b	1294011900		
DC110V		1a1b	1294012000		
DC125V		1a1b	1294012100		
DC200V		1a1b	1294012200		
DC220V		1a1b	1294012300		
DC250V		1a1b	1294012400		

Catalogue numbers

Susol

Contactors

MC-95 screw type 1a1b



95AF

Model	Terminal type	Coil voltage	Frequency	Aux.contact	Code
MC-95	Screw	AC24V	50/60Hz	1a1b	1295006300
		AC48V	50/60Hz	1a1b	1295006400
		AC100V	50/60Hz	1a1b	1295006500
		AC110V	50/60Hz	1a1b	1295006600
		AC120V	50/60Hz	1a1b	1295006700
		AC200V	50/60Hz	1a1b	1295006800
		AC220V	50/60Hz	1a1b	1295006900
		AC230V	50/60Hz	1a1b	1295007000
		AC240V	50/60Hz	1a1b	1295007100
		AC380V	50/60Hz	1a1b	1295007200
		AC400V	50/60Hz	1a1b	1295007300
		AC415V	50/60Hz	1a1b	1295007400
		AC440V	50/60Hz	1a1b	1295007500
		AC500V	50/60Hz	1a1b	1295007600
		AC550V	50/60Hz	1a1b	1295007700
		AC24V	50Hz	1a1b	1295007800
		AC36V	50Hz	1a1b	1295007900
		AC42V	50Hz	1a1b	1295008000
		AC48V	50Hz	1a1b	1295008100
		AC80V	50Hz	1a1b	1295008200
		AC100V	50Hz	1a1b	1295008300
		AC110V	50Hz	1a1b	1295008400
		AC220V	50Hz	1a1b	1295008500
		AC230V	50Hz	1a1b	1295008600
		AC240V	50Hz	1a1b	1295008700
		AC380V	50Hz	1a1b	1295008800
		AC400V	50Hz	1a1b	1295008900
		AC415V	50Hz	1a1b	1295009000
		AC440V	50Hz	1a1b	1295009100
		AC500V	50Hz	1a1b	1295009200
		AC550V	50Hz	1a1b	1295009300
		AC24V	60Hz	1a1b	1295009400
		AC48V	60Hz	1a1b	1295009500
		AC100V	60Hz	1a1b	1295009600
		AC110V	60Hz	1a1b	1295009700
		AC120V	60Hz	1a1b	1295009800
		AC200V	60Hz	1a1b	1295009900
		AC208V	60Hz	1a1b	1295010000
		AC220V	60Hz	1a1b	1295010100
		AC230V	60Hz	1a1b	1295010200
		AC240V	60Hz	1a1b	1295010300
		AC277V	60Hz		1295010400
		AC380V	60Hz		1295010500
		AC440V	60Hz		1295010600
		AC480V	60Hz		1295010700
AC600V	60Hz		1295010800		
AC100V, AC110V	50Hz, 60Hz		1295010900		
AC110V, AC120V	50Hz, 60Hz		1295011000		
AC200V, AC220V	50Hz, 60Hz		1295011100		
AC240V, AC277V	50Hz, 60Hz		1295011200		
DC12V			1295011300		
DC20V			1295011400		
DC24V			1295011500		
DC48V			1295011600		
DC60V			1295011700		
DC80V			1295011800		
DC100V			1295011900		
DC110V			1295012000		
DC125V			1295012100		
DC200V			1295012200		
DC220V			1295012300		
DC250V			1295012400		

Catalogue numbers

Susol

Contactors

MC-9 screw only type 2a2b



32AF

Model	Terminal type	Coil voltage	Frequency	Aux.contact	Code
MC-9	Screw only	AC24V	50/60Hz	2a2b	1275012500
		AC48V	50/60Hz	2a2b	1275012600
		AC100V	50/60Hz	2a2b	1275012700
		AC110V	50/60Hz	2a2b	1275012800
		AC120V	50/60Hz	2a2b	1275012900
		AC200V	50/60Hz	2a2b	1275013000
		AC220V	50/60Hz	2a2b	1275013100
		AC230V	50/60Hz	2a2b	1275013200
		AC240V	50/60Hz	2a2b	1275013300
		AC380V	50/60Hz	2a2b	1275013400
		AC400V	50/60Hz	2a2b	1275013500
		AC415V	50/60Hz	2a2b	1275013600
		AC440V	50/60Hz	2a2b	1275013700
		AC500V	50/60Hz	2a2b	1275013800
		AC550V	50/60Hz	2a2b	1275013900
		AC24V	50Hz	2a2b	1275014000
		AC36V	50Hz	2a2b	1275014100
		AC42V	50Hz	2a2b	1275014200
		AC48V	50Hz	2a2b	1275014300
		AC80V	50Hz	2a2b	1275014400
		AC100V	50Hz	2a2b	1275014500
		AC110V	50Hz	2a2b	1275014600
		AC220V	50Hz	2a2b	1275014700
		AC230V	50Hz	2a2b	1275014800
		AC240V	50Hz	2a2b	1275014900
		AC380V	50Hz	2a2b	1275015000
		AC400V	50Hz	2a2b	1275015100
		AC415V	50Hz	2a2b	1275015200
		AC440V	50Hz	2a2b	1275015300
		AC500V	50Hz	2a2b	1275015400
		AC550V	50Hz	2a2b	1275015500
		AC24V	60Hz	2a2b	1275015600
		AC48V	60Hz	2a2b	1275015700
		AC100V	60Hz	2a2b	1275015800
		AC110V	60Hz	2a2b	1275015900
		AC120V	60Hz	2a2b	1275016000
		AC200V	60Hz	2a2b	1275016100
		AC208V	60Hz	2a2b	1275016200
		AC220V	60Hz	2a2b	1275016300
		AC230V	60Hz	2a2b	1275016400
		AC240V	60Hz	2a2b	1275016500
		AC277V	60Hz	2a2b	1275016600
		AC380V	60Hz	2a2b	1275016700
		AC440V	60Hz	2a2b	1275016800
		AC480V	60Hz	2a2b	1275016900
		AC600V	60Hz	2a2b	1275017000
		AC100V, AC110V	50Hz, 60Hz	2a2b	1275017100
AC110V, AC120V	50Hz, 60Hz	2a2b	1275017200		
AC200V, AC220V	50Hz, 60Hz	2a2b	1275017300		
AC240V, AC277V	50Hz, 60Hz	2a2b	1275017400		
DC12V		2a2b	1275017500		
DC20V		2a2b	1275017600		
DC24V		2a2b	1275017700		
DC48V		2a2b	1275017800		
DC60V		2a2b	1275017900		
DC80V		2a2b	1275018000		
DC100V		2a2b	1275018100		
DC110V		2a2b	1275018200		
DC125V		2a2b	1275018300		
DC200V		2a2b	1275018400		
DC220V		2a2b	1275018500		
DC250V		2a2b	1275018600		

Catalogue numbers

Susol

Contactors

MC-12 screw only type 2a2b



32AF

Model	Terminal type	Coil voltage	Frequency	Aux.contact	Code
MC-12	Screw only	AC24V	50/60Hz	2a2b	1276012500
		AC48V	50/60Hz	2a2b	1276012600
		AC100V	50/60Hz	2a2b	1276012700
		AC110V	50/60Hz	2a2b	1276012800
		AC120V	50/60Hz	2a2b	1276012900
		AC200V	50/60Hz	2a2b	1276013000
		AC220V	50/60Hz	2a2b	1276013100
		AC230V	50/60Hz	2a2b	1276013200
		AC240V	50/60Hz	2a2b	1276013300
		AC380V	50/60Hz	2a2b	1276013400
		AC400V	50/60Hz	2a2b	1276013500
		AC415V	50/60Hz	2a2b	1276013600
		AC440V	50/60Hz	2a2b	1276013700
		AC500V	50/60Hz	2a2b	1276013800
		AC550V	50/60Hz	2a2b	1276013900
		AC24V	50Hz	2a2b	1276014000
		AC36V	50Hz	2a2b	1276014100
		AC42V	50Hz	2a2b	1276014200
		AC48V	50Hz	2a2b	1276014300
		AC80V	50Hz	2a2b	1276014400
		AC100V	50Hz	2a2b	1276014500
		AC110V	50Hz	2a2b	1276014600
		AC220V	50Hz	2a2b	1276014700
		AC230V	50Hz	2a2b	1276014800
		AC240V	50Hz	2a2b	1276014900
		AC380V	50Hz	2a2b	1276015000
		AC400V	50Hz	2a2b	1276015100
		AC415V	50Hz	2a2b	1276015200
		AC440V	50Hz	2a2b	1276015300
		AC500V	50Hz	2a2b	1276015400
		AC550V	50Hz	2a2b	1276015500
		AC24V	60Hz	2a2b	1276015600
		AC48V	60Hz	2a2b	1276015700
		AC100V	60Hz	2a2b	1276015800
		AC110V	60Hz	2a2b	1276015900
		AC120V	60Hz	2a2b	1276016000
		AC200V	60Hz	2a2b	1276016100
		AC208V	60Hz	2a2b	1276016200
		AC220V	60Hz	2a2b	1276016300
		AC230V	60Hz	2a2b	1276016400
		AC240V	60Hz	2a2b	1276016500
		AC277V	60Hz	2a2b	1276016600
		AC380V	60Hz	2a2b	1276016700
		AC440V	60Hz	2a2b	1276016800
		AC480V	60Hz	2a2b	1276016900
		AC600V	60Hz	2a2b	1276017000
		AC100V, AC110V	50Hz, 60Hz	2a2b	1276017100
		AC110V, AC120V	50Hz, 60Hz	2a2b	1276017200
		AC200V, AC220V	50Hz, 60Hz	2a2b	1276017300
		AC240V, AC277V	50Hz, 60Hz	2a2b	1276017400
DC12V		2a2b	1276017500		
DC20V		2a2b	1276017600		
DC24V		2a2b	1276017700		
DC48V		2a2b	1276017800		
DC60V		2a2b	1276017900		
DC80V		2a2b	1276018000		
DC100V		2a2b	1276018100		
DC110V		2a2b	1276018200		
DC125V		2a2b	1276018300		
DC200V		2a2b	1276018400		
DC220V		2a2b	1276018500		
DC250V		2a2b	1276018600		

Catalogue numbers

Susol

Contactors

MC-18 screw only type 2a2b



32AF

Model	Terminal type	Coil voltage	Frequency	Aux.contact	Code
MC-18	Screw only	AC24V	50/60Hz	2a2b	1277012500
		AC48V	50/60Hz	2a2b	1277012600
		AC100V	50/60Hz	2a2b	1277012700
		AC110V	50/60Hz	2a2b	1277012800
		AC120V	50/60Hz	2a2b	1277012900
		AC200V	50/60Hz	2a2b	1277013000
		AC220V	50/60Hz	2a2b	1277013100
		AC230V	50/60Hz	2a2b	1277013200
		AC240V	50/60Hz	2a2b	1277013300
		AC380V	50/60Hz	2a2b	1277013400
		AC400V	50/60Hz	2a2b	1277013500
		AC415V	50/60Hz	2a2b	1277013600
		AC440V	50/60Hz	2a2b	1277013700
		AC500V	50/60Hz	2a2b	1277013800
		AC550V	50/60Hz	2a2b	1277013900
		AC24V	50Hz	2a2b	1277014000
		AC36V	50Hz	2a2b	1277014100
		AC42V	50Hz	2a2b	1277014200
		AC48V	50Hz	2a2b	1277014300
		AC80V	50Hz	2a2b	1277014400
		AC100V	50Hz	2a2b	1277014500
		AC110V	50Hz	2a2b	1277014600
		AC220V	50Hz	2a2b	1277014700
		AC230V	50Hz	2a2b	1277014800
		AC240V	50Hz	2a2b	1277014900
		AC380V	50Hz	2a2b	1277015000
		AC400V	50Hz	2a2b	1277015100
		AC415V	50Hz	2a2b	1277015200
		AC440V	50Hz	2a2b	1277015300
		AC500V	50Hz	2a2b	1277015400
		AC550V	50Hz	2a2b	1277015500
		AC24V	60Hz	2a2b	1277015600
		AC48V	60Hz	2a2b	1277015700
		AC100V	60Hz	2a2b	1277015800
		AC110V	60Hz	2a2b	1277015900
		AC120V	60Hz	2a2b	1277016000
		AC200V	60Hz	2a2b	1277016100
		AC208V	60Hz	2a2b	1277016200
		AC220V	60Hz	2a2b	1277016300
		AC230V	60Hz	2a2b	1277016400
		AC240V	60Hz	2a2b	1277016500
		AC277V	60Hz	2a2b	1277016600
		AC380V	60Hz	2a2b	1277016700
		AC440V	60Hz	2a2b	1277016800
		AC480V	60Hz	2a2b	1277016900
		AC600V	60Hz	2a2b	1277017000
		AC100V, AC110V	50Hz, 60Hz	2a2b	1277017100
AC110V, AC120V	50Hz, 60Hz	2a2b	1277017200		
AC200V, AC220V	50Hz, 60Hz	2a2b	1277017300		
AC240V, AC277V	50Hz, 60Hz	2a2b	1277017400		
DC12V		2a2b	1277017500		
DC20V		2a2b	1277017600		
DC24V		2a2b	1277017700		
DC48V		2a2b	1277017800		
DC60V		2a2b	1277017900		
DC80V		2a2b	1277018000		
DC100V		2a2b	1277018100		
DC110V		2a2b	1277018200		
DC125V		2a2b	1277018300		
DC200V		2a2b	1277018400		
DC220V		2a2b	1277018500		
DC250V		2a2b	1277018600		

Catalogue numbers

Susol

Contactors

MC-25 screw only type 2a2b



32AF

Model	Terminal type	Coil voltage	Frequency	Aux.contact	Code
MC-25	Screw only	AC24V	50/60Hz	2a2b	1278012500
		AC48V	50/60Hz	2a2b	1278012600
		AC100V	50/60Hz	2a2b	1278012700
		AC110V	50/60Hz	2a2b	1278012800
		AC120V	50/60Hz	2a2b	1278012900
		AC200V	50/60Hz	2a2b	1278013000
		AC220V	50/60Hz	2a2b	1278013100
		AC230V	50/60Hz	2a2b	1278013200
		AC240V	50/60Hz	2a2b	1278013300
		AC380V	50/60Hz	2a2b	1278013400
		AC400V	50/60Hz	2a2b	1278013500
		AC415V	50/60Hz	2a2b	1278013600
		AC440V	50/60Hz	2a2b	1278013700
		AC500V	50/60Hz	2a2b	1278013800
		AC550V	50/60Hz	2a2b	1278013900
		AC24V	50Hz	2a2b	1278014000
		AC36V	50Hz	2a2b	1278014100
		AC42V	50Hz	2a2b	1278014200
		AC48V	50Hz	2a2b	1278014300
		AC80V	50Hz	2a2b	1278014400
		AC100V	50Hz	2a2b	1278014500
		AC110V	50Hz	2a2b	1278014600
		AC220V	50Hz	2a2b	1278014700
		AC230V	50Hz	2a2b	1278014800
		AC240V	50Hz	2a2b	1278014900
		AC380V	50Hz	2a2b	1278015000
		AC400V	50Hz	2a2b	1278015100
		AC415V	50Hz	2a2b	1278015200
		AC440V	50Hz	2a2b	1278015300
		AC500V	50Hz	2a2b	1278015400
		AC550V	50Hz	2a2b	1278015500
		AC24V	60Hz	2a2b	1278015600
		AC48V	60Hz	2a2b	1278015700
		AC100V	60Hz	2a2b	1278015800
		AC110V	60Hz	2a2b	1278015900
		AC120V	60Hz	2a2b	1278016000
		AC200V	60Hz	2a2b	1278016100
		AC208V	60Hz	2a2b	1278016200
		AC220V	60Hz	2a2b	1278016300
		AC230V	60Hz	2a2b	1278016400
		AC240V	60Hz	2a2b	1278016500
		AC277V	60Hz	2a2b	1278016600
		AC380V	60Hz	2a2b	1278016700
		AC440V	60Hz	2a2b	1278016800
		AC480V	60Hz	2a2b	1278016900
		AC600V	60Hz	2a2b	1278017000
		AC100V, AC110V	50Hz, 60Hz	2a2b	1278017100
		AC110V, AC120V	50Hz, 60Hz	2a2b	1278017200
		AC200V, AC220V	50Hz, 60Hz	2a2b	1278017300
		AC240V, AC277V	50Hz, 60Hz	2a2b	1278017400
DC12V		2a2b	1278017500		
DC20V		2a2b	1278017600		
DC24V		2a2b	1278017700		
DC48V		2a2b	1278017800		
DC60V		2a2b	1278017900		
DC80V		2a2b	1278018000		
DC100V		2a2b	1278018100		
DC110V		2a2b	1278018200		
DC125V		2a2b	1278018300		
DC200V		2a2b	1278018400		
DC220V		2a2b	1278018500		
DC250V		2a2b	1278018600		

Catalogue numbers

Susol

Contactors

MC-32 screw only type 2a2b



32AF

Model	Terminal type	Coil voltage	Frequency	Aux.contact	Code
MC-32	Screw only	AC24V	50/60Hz	2a2b	1279012500
		AC48V	50/60Hz	2a2b	1279012600
		AC100V	50/60Hz	2a2b	1279012700
		AC110V	50/60Hz	2a2b	1279012800
		AC120V	50/60Hz	2a2b	1279012900
		AC200V	50/60Hz	2a2b	1279013000
		AC220V	50/60Hz	2a2b	1279013100
		AC230V	50/60Hz	2a2b	1279013200
		AC240V	50/60Hz	2a2b	1279013300
		AC380V	50/60Hz	2a2b	1279013400
		AC400V	50/60Hz	2a2b	1279013500
		AC415V	50/60Hz	2a2b	1279013600
		AC440V	50/60Hz	2a2b	1279013700
		AC500V	50/60Hz	2a2b	1279013800
		AC550V	50/60Hz	2a2b	1279013900
		AC24V	50Hz	2a2b	1279014000
		AC36V	50Hz	2a2b	1279014100
		AC42V	50Hz	2a2b	1279014200
		AC48V	50Hz	2a2b	1279014300
		AC80V	50Hz	2a2b	1279014400
		AC100V	50Hz	2a2b	1279014500
		AC110V	50Hz	2a2b	1279014600
		AC220V	50Hz	2a2b	1279014700
		AC230V	50Hz	2a2b	1279014800
		AC240V	50Hz	2a2b	1279014900
		AC380V	50Hz	2a2b	1279015000
		AC400V	50Hz	2a2b	1279015100
		AC415V	50Hz	2a2b	1279015200
		AC440V	50Hz	2a2b	1279015300
		AC500V	50Hz	2a2b	1279015400
		AC550V	50Hz	2a2b	1279015500
		AC24V	60Hz	2a2b	1279015600
		AC48V	60Hz	2a2b	1279015700
		AC100V	60Hz	2a2b	1279015800
		AC110V	60Hz	2a2b	1279015900
		AC120V	60Hz	2a2b	1279016000
		AC200V	60Hz	2a2b	1279016100
		AC208V	60Hz	2a2b	1279016200
		AC220V	60Hz	2a2b	1279016300
		AC230V	60Hz	2a2b	1279016400
		AC240V	60Hz	2a2b	1279016500
		AC277V	60Hz	2a2b	1279016600
		AC380V	60Hz	2a2b	1279016700
		AC440V	60Hz	2a2b	1279016800
		AC480V	60Hz	2a2b	1279016900
		AC600V	60Hz	2a2b	1279017000
		AC100V, AC110V	50Hz, 60Hz	2a2b	1279017100
		AC110V, AC120V	50Hz, 60Hz	2a2b	1279017200
		AC200V, AC220V	50Hz, 60Hz	2a2b	1279017300
		AC240V, AC277V	50Hz, 60Hz	2a2b	1279017400
DC12V		2a2b	1279017500		
DC20V		2a2b	1279017600		
DC24V		2a2b	1279017700		
DC48V		2a2b	1279017800		
DC60V		2a2b	1279017900		
DC80V		2a2b	1279018000		
DC100V		2a2b	1279018100		
DC110V		2a2b	1279018200		
DC125V		2a2b	1279018300		
DC200V		2a2b	1279018400		
DC220V		2a2b	1279018500		
DC250V		2a2b	1279018600		

Catalogue numbers

Susol

Contactors

MC-35 lug type 2a2b



63AF

Model	Terminal type	Coil voltage	Frequency	Aux.contact	Code
MC-35	AC24V	50/60Hz	2a2b	1280012500	
		AC48V	50/60Hz	2a2b	1280012600
		AC100V	50/60Hz	2a2b	1280012700
		AC110V	50/60Hz	2a2b	1280012800
		AC120V	50/60Hz	2a2b	1280012900
		AC200V	50/60Hz	2a2b	1280013000
		AC220V	50/60Hz	2a2b	1280013100
		AC230V	50/60Hz	2a2b	1280013200
		AC240V	50/60Hz	2a2b	1280013300
		AC380V	50/60Hz	2a2b	1280013400
		AC400V	50/60Hz	2a2b	1280013500
		AC415V	50/60Hz	2a2b	1280013600
		AC440V	50/60Hz	2a2b	1280013700
		AC500V	50/60Hz	2a2b	1280013800
		AC550V	50/60Hz	2a2b	1280013900
		AC24V	50Hz	2a2b	1280014000
		AC36V	50Hz	2a2b	1280014100
		AC42V	50Hz	2a2b	1280014200
		AC48V	50Hz	2a2b	1280014300
		AC80V	50Hz	2a2b	1280014400
		AC100V	50Hz	2a2b	1280014500
		AC110V	50Hz	2a2b	1280014600
		AC220V	50Hz	2a2b	1280014700
		AC230V	50Hz	2a2b	1280014800
		AC240V	50Hz	2a2b	1280014900
		AC380V	50Hz	2a2b	1280015000
		AC400V	50Hz	2a2b	1280015100
	AC415V	50Hz	2a2b	1280015200	
	AC440V	50Hz	2a2b	1280015300	
	AC500V	50Hz	2a2b	1280015400	
	AC550V	50Hz	2a2b	1280015500	
	AC24V	60Hz	2a2b	1280015600	
	AC48V	60Hz	2a2b	1280015700	
	AC100V	60Hz	2a2b	1280015800	
	AC110V	60Hz	2a2b	1280015900	
	AC120V	60Hz	2a2b	1280016000	
	AC200V	60Hz	2a2b	1280016100	
	AC208V	60Hz	2a2b	1280016200	
	AC220V	60Hz	2a2b	1280016300	
	AC230V	60Hz	2a2b	1280016400	
	AC240V	60Hz	2a2b	1280016500	
	AC277V	60Hz	2a2b	1280016600	
	AC380V	60Hz	2a2b	1280016700	
	AC440V	60Hz	2a2b	1280016800	
	AC480V	60Hz	2a2b	1280016900	
	AC600V	60Hz	2a2b	1280017000	
	AC100V, AC110V	50Hz, 60Hz	2a2b	1280017100	
	AC110V, AC120V	50Hz, 60Hz	2a2b	1280017200	
	AC200V, AC220V	50Hz, 60Hz	2a2b	1280017300	
	AC240V, AC277V	50Hz, 60Hz	2a2b	1280017400	
DC12V		2a2b	1280017500		
DC20V		2a2b	1280017600		
DC24V		2a2b	1280017700		
DC48V		2a2b	1280017800		
DC60V		2a2b	1280017900		
DC80V		2a2b	1280018000		
DC100V		2a2b	1280018100		
DC110V		2a2b	1280018200		
DC125V		2a2b	1280018300		
DC200V		2a2b	1280018400		
DC220V		2a2b	1280018500		
DC250V		2a2b	1280018600		

Catalogue numbers

Susol

Contactors

MC-40 lug type 2a2b



63AF

Model	Terminal type	Coil voltage	Frequency	Aux.contact	Code
MC-40	Lug	AC24V	50/60Hz	2a2b	1281012500
		AC48V	50/60Hz	2a2b	1281012600
		AC100V	50/60Hz	2a2b	1281012700
		AC110V	50/60Hz	2a2b	1281012800
		AC120V	50/60Hz	2a2b	1281012900
		AC200V	50/60Hz	2a2b	1281013000
		AC220V	50/60Hz	2a2b	1281013100
		AC230V	50/60Hz	2a2b	1281013200
		AC240V	50/60Hz	2a2b	1281013300
		AC380V	50/60Hz	2a2b	1281013400
		AC400V	50/60Hz	2a2b	1281013500
		AC415V	50/60Hz	2a2b	1281013600
		AC440V	50/60Hz	2a2b	1281013700
		AC500V	50/60Hz	2a2b	1281013800
		AC550V	50/60Hz	2a2b	1281013900
		AC24V	50Hz	2a2b	1281014000
		AC36V	50Hz	2a2b	1281014100
		AC42V	50Hz	2a2b	1281014200
		AC48V	50Hz	2a2b	1281014300
		AC80V	50Hz	2a2b	1281014400
		AC100V	50Hz	2a2b	1281014500
		AC110V	50Hz	2a2b	1281014600
		AC220V	50Hz	2a2b	1281014700
		AC230V	50Hz	2a2b	1281014800
		AC240V	50Hz	2a2b	1281014900
		AC380V	50Hz	2a2b	1281015000
		AC400V	50Hz	2a2b	1281015100
		AC415V	50Hz	2a2b	1281015200
		AC440V	50Hz	2a2b	1281015300
		AC500V	50Hz	2a2b	1281015400
		AC550V	50Hz	2a2b	1281015500
		AC24V	60Hz	2a2b	1281015600
		AC48V	60Hz	2a2b	1281015700
		AC100V	60Hz	2a2b	1281015800
		AC110V	60Hz	2a2b	1281015900
		AC120V	60Hz	2a2b	1281016000
		AC200V	60Hz	2a2b	1281016100
		AC208V	60Hz	2a2b	1281016200
		AC220V	60Hz	2a2b	1281016300
		AC230V	60Hz	2a2b	1281016400
		AC240V	60Hz	2a2b	1281016500
		AC277V	60Hz	2a2b	1281016600
		AC380V	60Hz	2a2b	1281016700
		AC440V	60Hz	2a2b	1281016800
		AC480V	60Hz	2a2b	1281016900
AC600V	60Hz	2a2b	1281017000		
AC100V, AC110V	50Hz, 60Hz	2a2b	1281017100		
AC110V, AC120V	50Hz, 60Hz	2a2b	1281017200		
AC200V, AC220V	50Hz, 60Hz	2a2b	1281017300		
AC240V, AC277V	50Hz, 60Hz	2a2b	1281017400		
DC12V		2a2b	1281017500		
DC20V		2a2b	1281017600		
DC24V		2a2b	1281017700		
DC48V		2a2b	1281017800		
DC60V		2a2b	1281017900		
DC80V		2a2b	1281018000		
DC100V		2a2b	1281018100		
DC110V		2a2b	1281018200		
DC125V		2a2b	1281018300		
DC200V		2a2b	1281018400		
DC220V		2a2b	1281018500		
DC250V		2a2b	1281018600		

Catalogue numbers

Susol

Contactors

MC-50 lug type 2a2b



63AF

Model	Terminal type	Coil voltage	Frequency	Aux.contact	Code
MC-50	Lug	AC24V	50/60Hz	2a2b	1282012500
		AC48V	50/60Hz	2a2b	1282012600
		AC100V	50/60Hz	2a2b	1282012700
		AC110V	50/60Hz	2a2b	1282012800
		AC120V	50/60Hz	2a2b	1282012900
		AC200V	50/60Hz	2a2b	1282013000
		AC220V	50/60Hz	2a2b	1282013100
		AC230V	50/60Hz	2a2b	1282013200
		AC240V	50/60Hz	2a2b	1282013300
		AC380V	50/60Hz	2a2b	1282013400
		AC400V	50/60Hz	2a2b	1282013500
		AC415V	50/60Hz	2a2b	1282013600
		AC440V	50/60Hz	2a2b	1282013700
		AC500V	50/60Hz	2a2b	1282013800
		AC550V	50/60Hz	2a2b	1282013900
		AC24V	50Hz	2a2b	1282014000
		AC36V	50Hz	2a2b	1282014100
		AC42V	50Hz	2a2b	1282014200
		AC48V	50Hz	2a2b	1282014300
		AC80V	50Hz	2a2b	1282014400
		AC100V	50Hz	2a2b	1282014500
		AC110V	50Hz	2a2b	1282014600
		AC220V	50Hz	2a2b	1282014700
		AC230V	50Hz	2a2b	1282014800
		AC240V	50Hz	2a2b	1282014900
		AC380V	50Hz	2a2b	1282015000
		AC400V	50Hz	2a2b	1282015100
		AC415V	50Hz	2a2b	1282015200
		AC440V	50Hz	2a2b	1282015300
		AC500V	50Hz	2a2b	1282015400
		AC550V	50Hz	2a2b	1282015500
		AC24V	60Hz	2a2b	1282015600
		AC48V	60Hz	2a2b	1282015700
		AC100V	60Hz	2a2b	1282015800
		AC110V	60Hz	2a2b	1282015900
		AC120V	60Hz	2a2b	1282016000
		AC200V	60Hz	2a2b	1282016100
		AC208V	60Hz	2a2b	1282016200
		AC220V	60Hz	2a2b	1282016300
		AC230V	60Hz	2a2b	1282016400
		AC240V	60Hz	2a2b	1282016500
		AC277V	60Hz	2a2b	1282016600
		AC380V	60Hz	2a2b	1282016700
		AC440V	60Hz	2a2b	1282016800
		AC480V	60Hz	2a2b	1282016900
		AC600V	60Hz	2a2b	1282017000
		AC100V, AC110V	50Hz, 60Hz	2a2b	1282017100
AC110V, AC120V	50Hz, 60Hz	2a2b	1282017200		
AC200V, AC220V	50Hz, 60Hz	2a2b	1282017300		
AC240V, AC277V	50Hz, 60Hz	2a2b	1282017400		
DC12V		2a2b	1282017500		
DC20V		2a2b	1282017600		
DC24V		2a2b	1282017700		
DC48V		2a2b	1282017800		
DC60V		2a2b	1282017900		
DC80V		2a2b	1282018000		
DC100V		2a2b	1282018100		
DC110V		2a2b	1282018200		
DC125V		2a2b	1282018300		
DC200V		2a2b	1282018400		
DC220V		2a2b	1282018500		
DC250V		2a2b	1282018600		

Catalogue numbers

Susol

Contactors

MC-63 lug type 2a2b



63AF

Model	Terminal type	Coil voltage	Frequency	Aux.contact	Code
MC-63	Lug	AC24V	50/60Hz	2a2b	1283012500
		AC48V	50/60Hz	2a2b	1283012600
		AC100V	50/60Hz	2a2b	1283012700
		AC110V	50/60Hz	2a2b	1283012800
		AC120V	50/60Hz	2a2b	1283012900
		AC200V	50/60Hz	2a2b	1283013000
		AC220V	50/60Hz	2a2b	1283013100
		AC230V	50/60Hz	2a2b	1283013200
		AC240V	50/60Hz	2a2b	1283013300
		AC380V	50/60Hz	2a2b	1283013400
		AC400V	50/60Hz	2a2b	1283013500
		AC415V	50/60Hz	2a2b	1283013600
		AC440V	50/60Hz	2a2b	1283013700
		AC500V	50/60Hz	2a2b	1283013800
		AC550V	50/60Hz	2a2b	1283013900
		AC24V	50Hz	2a2b	1283014000
		AC36V	50Hz	2a2b	1283014100
		AC42V	50Hz	2a2b	1283014200
		AC48V	50Hz	2a2b	1283014300
		AC80V	50Hz	2a2b	1283014400
		AC100V	50Hz	2a2b	1283014500
		AC110V	50Hz	2a2b	1283014600
		AC220V	50Hz	2a2b	1283014700
		AC230V	50Hz	2a2b	1283014800
		AC240V	50Hz	2a2b	1283014900
		AC380V	50Hz	2a2b	1283015000
		AC400V	50Hz	2a2b	1283015100
		AC415V	50Hz	2a2b	1283015200
		AC440V	50Hz	2a2b	1283015300
		AC500V	50Hz	2a2b	1283015400
		AC550V	50Hz	2a2b	1283015500
		AC24V	60Hz	2a2b	1283015600
		AC48V	60Hz	2a2b	1283015700
		AC100V	60Hz	2a2b	1283015800
		AC110V	60Hz	2a2b	1283015900
		AC120V	60Hz	2a2b	1283016000
		AC200V	60Hz	2a2b	1283016100
		AC208V	60Hz	2a2b	1283016200
		AC220V	60Hz	2a2b	1283016300
		AC230V	60Hz	2a2b	1283016400
		AC240V	60Hz	2a2b	1283016500
		AC277V	60Hz	2a2b	1283016600
		AC380V	60Hz	2a2b	1283016700
		AC440V	60Hz	2a2b	1283016800
		AC480V	60Hz	2a2b	1283016900
		AC600V	60Hz	2a2b	1283017000
		AC100V, AC110V	50Hz, 60Hz	2a2b	1283017100
AC110V, AC120V	50Hz, 60Hz	2a2b	1283017200		
AC200V, AC220V	50Hz, 60Hz	2a2b	1283017300		
AC240V, AC277V	50Hz, 60Hz	2a2b	1283017400		
DC12V		2a2b	1283017500		
DC20V		2a2b	1283017600		
DC24V		2a2b	1283017700		
DC48V		2a2b	1283017800		
DC60V		2a2b	1283017900		
DC80V		2a2b	1283018000		
DC100V		2a2b	1283018100		
DC110V		2a2b	1283018200		
DC125V		2a2b	1283018300		
DC200V		2a2b	1283018400		
DC220V		2a2b	1283018500		
DC250V		2a2b	1283018600		

Catalogue numbers

Susol

Contactors

MC-65 lug type 2a2b



95AF

Model	Terminal type	Coil voltage	Frequency	Aux.contact	Code
MC-65	Lug	AC24V	50/60Hz	2a2b	1284012500
		AC48V	50/60Hz	2a2b	1284012600
		AC100V	50/60Hz	2a2b	1284012700
		AC110V	50/60Hz	2a2b	1284012800
		AC120V	50/60Hz	2a2b	1284012900
		AC200V	50/60Hz	2a2b	1284013000
		AC220V	50/60Hz	2a2b	1284013100
		AC230V	50/60Hz	2a2b	1284013200
		AC240V	50/60Hz	2a2b	1284013300
		AC380V	50/60Hz	2a2b	1284013400
		AC400V	50/60Hz	2a2b	1284013500
		AC415V	50/60Hz	2a2b	1284013600
		AC440V	50/60Hz	2a2b	1284013700
		AC500V	50/60Hz	2a2b	1284013800
		AC550V	50/60Hz	2a2b	1284013900
		AC24V	50Hz	2a2b	1284014000
		AC36V	50Hz	2a2b	1284014100
		AC42V	50Hz	2a2b	1284014200
		AC48V	50Hz	2a2b	1284014300
		AC80V	50Hz	2a2b	1284014400
		AC100V	50Hz	2a2b	1284014500
		AC110V	50Hz	2a2b	1284014600
		AC220V	50Hz	2a2b	1284014700
		AC230V	50Hz	2a2b	1284014800
		AC240V	50Hz	2a2b	1284014900
		AC380V	50Hz	2a2b	1284015000
		AC400V	50Hz	2a2b	1284015100
		AC415V	50Hz	2a2b	1284015200
		AC440V	50Hz	2a2b	1284015300
		AC500V	50Hz	2a2b	1284015400
		AC550V	50Hz	2a2b	1284015500
		AC24V	60Hz	2a2b	1284015600
		AC48V	60Hz	2a2b	1284015700
		AC100V	60Hz	2a2b	1284015800
		AC110V	60Hz	2a2b	1284015900
		AC120V	60Hz	2a2b	1284016000
		AC200V	60Hz	2a2b	1284016100
		AC208V	60Hz	2a2b	1284016200
		AC220V	60Hz	2a2b	1284016300
		AC230V	60Hz	2a2b	1284016400
		AC240V	60Hz	2a2b	1284016500
		AC277V	60Hz	2a2b	1284016600
		AC380V	60Hz	2a2b	1284016700
		AC440V	60Hz	2a2b	1284016800
		AC480V	60Hz	2a2b	1284016900
		AC600V	60Hz	2a2b	1284017000
		AC100V, AC110V	50Hz, 60Hz	2a2b	1284017100
		AC110V, AC120V	50Hz, 60Hz	2a2b	1284017200
		AC200V, AC220V	50Hz, 60Hz	2a2b	1284017300
		AC240V, AC277V	50Hz, 60Hz	2a2b	1284017400
DC12V		2a2b	1284017500		
DC20V		2a2b	1284017600		
DC24V		2a2b	1284017700		
DC48V		2a2b	1284017800		
DC60V		2a2b	1284017900		
DC80V		2a2b	1284018000		
DC100V		2a2b	1284018100		
DC110V		2a2b	1284018200		
DC125V		2a2b	1284018300		
DC200V		2a2b	1284018400		
DC220V		2a2b	1284018500		
DC250V		2a2b	1284018600		

Catalogue numbers

Susol

Contactors

MC-75 lug type 2a2b



95AF

Model	Terminal type	Coil voltage	Frequency	Aux.contact	Code
MC-75	Lug	AC24V	50/60Hz	2a2b	1285012500
		AC48V	50/60Hz	2a2b	1285012600
		AC100V	50/60Hz	2a2b	1285012700
		AC110V	50/60Hz	2a2b	1285012800
		AC120V	50/60Hz	2a2b	1285012900
		AC200V	50/60Hz	2a2b	1285013000
		AC220V	50/60Hz	2a2b	1285013100
		AC230V	50/60Hz	2a2b	1285013200
		AC240V	50/60Hz	2a2b	1285013300
		AC380V	50/60Hz	2a2b	1285013400
		AC400V	50/60Hz	2a2b	1285013500
		AC415V	50/60Hz	2a2b	1285013600
		AC440V	50/60Hz	2a2b	1285013700
		AC500V	50/60Hz	2a2b	1285013800
		AC550V	50/60Hz	2a2b	1285013900
		AC24V	50Hz	2a2b	1285014000
		AC36V	50Hz	2a2b	1285014100
		AC42V	50Hz	2a2b	1285014200
		AC48V	50Hz	2a2b	1285014300
		AC80V	50Hz	2a2b	1285014400
		AC100V	50Hz	2a2b	1285014500
		AC110V	50Hz	2a2b	1285014600
		AC220V	50Hz	2a2b	1285014700
		AC230V	50Hz	2a2b	1285014800
		AC240V	50Hz	2a2b	1285014900
		AC380V	50Hz	2a2b	1285015000
		AC400V	50Hz	2a2b	1285015100
		AC415V	50Hz	2a2b	1285015200
		AC440V	50Hz	2a2b	1285015300
		AC500V	50Hz	2a2b	1285015400
		AC550V	50Hz	2a2b	1285015500
		AC24V	60Hz	2a2b	1285015600
		AC48V	60Hz	2a2b	1285015700
		AC100V	60Hz	2a2b	1285015800
		AC110V	60Hz	2a2b	1285015900
		AC120V	60Hz	2a2b	1285016000
		AC200V	60Hz	2a2b	1285016100
		AC208V	60Hz	2a2b	1285016200
		AC220V	60Hz	2a2b	1285016300
		AC230V	60Hz	2a2b	1285016400
		AC240V	60Hz	2a2b	1285016500
		AC277V	60Hz	2a2b	1285016600
		AC380V	60Hz	2a2b	1285016700
		AC440V	60Hz	2a2b	1285016800
		AC480V	60Hz	2a2b	1285016900
		AC600V	60Hz	2a2b	1285017000
		AC100V, AC110V	50Hz, 60Hz	2a2b	1285017100
AC110V, AC120V	50Hz, 60Hz	2a2b	1285017200		
AC200V, AC220V	50Hz, 60Hz	2a2b	1285017300		
AC240V, AC277V	50Hz, 60Hz	2a2b	1285017400		
DC12V		2a2b	1285017500		
DC20V		2a2b	1285017600		
DC24V		2a2b	1285017700		
DC48V		2a2b	1285017800		
DC60V		2a2b	1285017900		
DC80V		2a2b	1285018000		
DC100V		2a2b	1285018100		
DC110V		2a2b	1285018200		
DC125V		2a2b	1285018300		
DC200V		2a2b	1285018400		
DC220V		2a2b	1285018500		
DC250V		2a2b	1285018600		

Catalogue numbers

Susol

Contactors

MC-85 lug type 2a2b



95AF

Model	Terminal type	Coil voltage	Frequency	Aux.contact	Code
MC-85	Lug	AC24V	50/60Hz	2a2b	1286012500
		AC48V	50/60Hz	2a2b	1286012600
		AC100V	50/60Hz	2a2b	1286012700
		AC110V	50/60Hz	2a2b	1286012800
		AC120V	50/60Hz	2a2b	1286012900
		AC200V	50/60Hz	2a2b	1286013000
		AC220V	50/60Hz	2a2b	1286013100
		AC230V	50/60Hz	2a2b	1286013200
		AC240V	50/60Hz	2a2b	1286013300
		AC380V	50/60Hz	2a2b	1286013400
		AC400V	50/60Hz	2a2b	1286013500
		AC415V	50/60Hz	2a2b	1286013600
		AC440V	50/60Hz	2a2b	1286013700
		AC500V	50/60Hz	2a2b	1286013800
		AC550V	50/60Hz	2a2b	1286013900
		AC24V	50Hz	2a2b	1286014000
		AC36V	50Hz	2a2b	1286014100
		AC42V	50Hz	2a2b	1286014200
		AC48V	50Hz	2a2b	1286014300
		AC80V	50Hz	2a2b	1286014400
		AC100V	50Hz	2a2b	1286014500
		AC110V	50Hz	2a2b	1286014600
		AC220V	50Hz	2a2b	1286014700
		AC230V	50Hz	2a2b	1286014800
		AC240V	50Hz	2a2b	1286014900
		AC380V	50Hz	2a2b	1286015000
		AC400V	50Hz	2a2b	1286015100
		AC415V	50Hz	2a2b	1286015200
		AC440V	50Hz	2a2b	1286015300
		AC500V	50Hz	2a2b	1286015400
		AC550V	50Hz	2a2b	1286015500
		AC24V	60Hz	2a2b	1286015600
		AC48V	60Hz	2a2b	1286015700
		AC100V	60Hz	2a2b	1286015800
		AC110V	60Hz	2a2b	1286015900
		AC120V	60Hz	2a2b	1286016000
		AC200V	60Hz	2a2b	1286016100
		AC208V	60Hz	2a2b	1286016200
		AC220V	60Hz	2a2b	1286016300
		AC230V	60Hz	2a2b	1286016400
		AC240V	60Hz	2a2b	1286016500
		AC277V	60Hz	2a2b	1286016600
		AC380V	60Hz	2a2b	1286016700
		AC440V	60Hz	2a2b	1286016800
		AC480V	60Hz	2a2b	1286016900
		AC600V	60Hz	2a2b	1286017000
		AC100V, AC110V	50Hz, 60Hz	2a2b	1286017100
		AC110V, AC120V	50Hz, 60Hz	2a2b	1286017200
		AC200V, AC220V	50Hz, 60Hz	2a2b	1286017300
		AC240V, AC277V	50Hz, 60Hz	2a2b	1286017400
DC12V		2a2b	1286017500		
DC20V		2a2b	1286017600		
DC24V		2a2b	1286017700		
DC48V		2a2b	1286017800		
DC60V		2a2b	1286017900		
DC80V		2a2b	1286018000		
DC100V		2a2b	1286018100		
DC110V		2a2b	1286018200		
DC125V		2a2b	1286018300		
DC200V		2a2b	1286018400		
DC220V		2a2b	1286018500		
DC250V		2a2b	1286018600		

Catalogue numbers

Susol

Contactors

MC-95 lug type 2a2b



95AF

Model	Terminal type	Coil voltage	Frequency	Aux.contact	Code
MC-95	Lug	AC24V	50/60Hz	2a2b	1287012500
		AC48V	50/60Hz	2a2b	1287012600
		AC100V	50/60Hz	2a2b	1287012700
		AC110V	50/60Hz	2a2b	1287012800
		AC120V	50/60Hz	2a2b	1287012900
		AC200V	50/60Hz	2a2b	1287013000
		AC220V	50/60Hz	2a2b	1287013100
		AC230V	50/60Hz	2a2b	1287013200
		AC240V	50/60Hz	2a2b	1287013300
		AC380V	50/60Hz	2a2b	1287013400
		AC400V	50/60Hz	2a2b	1287013500
		AC415V	50/60Hz	2a2b	1287013600
		AC440V	50/60Hz	2a2b	1287013700
		AC500V	50/60Hz	2a2b	1287013800
		AC550V	50/60Hz	2a2b	1287013900
		AC24V	50Hz	2a2b	1287014000
		AC36V	50Hz	2a2b	1287014100
		AC42V	50Hz	2a2b	1287014200
		AC48V	50Hz	2a2b	1287014300
		AC80V	50Hz	2a2b	1287014400
		AC100V	50Hz	2a2b	1287014500
		AC110V	50Hz	2a2b	1287014600
		AC220V	50Hz	2a2b	1287014700
		AC230V	50Hz	2a2b	1287014800
		AC240V	50Hz	2a2b	1287014900
		AC380V	50Hz	2a2b	1287015000
		AC400V	50Hz	2a2b	1287015100
		AC415V	50Hz	2a2b	1287015200
		AC440V	50Hz	2a2b	1287015300
		AC500V	50Hz	2a2b	1287015400
		AC550V	50Hz	2a2b	1287015500
		AC24V	60Hz	2a2b	1287015600
		AC48V	60Hz	2a2b	1287015700
		AC100V	60Hz	2a2b	1287015800
		AC110V	60Hz	2a2b	1287015900
		AC120V	60Hz	2a2b	1287016000
		AC200V	60Hz	2a2b	1287016100
		AC208V	60Hz	2a2b	1287016200
		AC220V	60Hz	2a2b	1287016300
		AC230V	60Hz	2a2b	1287016400
		AC240V	60Hz	2a2b	1287016500
		AC277V	60Hz	2a2b	1287016600
		AC380V	60Hz	2a2b	1287016700
		AC440V	60Hz	2a2b	1287016800
		AC480V	60Hz	2a2b	1287016900
		AC600V	60Hz	2a2b	1287017000
		AC100V, AC110V	50Hz, 60Hz	2a2b	1287017100
		AC110V, AC120V	50Hz, 60Hz	2a2b	1287017200
		AC200V, AC220V	50Hz, 60Hz	2a2b	1287017300
		AC240V, AC277V	50Hz, 60Hz	2a2b	1287017400
DC12V		2a2b	1287017500		
DC20V		2a2b	1287017600		
DC24V		2a2b	1287017700		
DC48V		2a2b	1287017800		
DC60V		2a2b	1287017900		
DC80V		2a2b	1287018000		
DC100V		2a2b	1287018100		
DC110V		2a2b	1287018200		
DC125V		2a2b	1287018300		
DC200V		2a2b	1287018400		
DC220V		2a2b	1287018500		
DC250V		2a2b	1287018600		

Catalogue numbers

Susol

Contactors

MC-35 screw type 2a2b



63AF

Model	Terminal type	Coil voltage	Frequency	Aux.contact	Code
MC-35	Screw	AC24V	50/60Hz	2a2b	1288012500
		AC48V	50/60Hz	2a2b	1288012600
		AC100V	50/60Hz	2a2b	1288012700
		AC110V	50/60Hz	2a2b	1288012800
		AC120V	50/60Hz	2a2b	1288012900
		AC200V	50/60Hz	2a2b	1288013000
		AC220V	50/60Hz	2a2b	1288013100
		AC230V	50/60Hz	2a2b	1288013200
		AC240V	50/60Hz	2a2b	1288013300
		AC380V	50/60Hz	2a2b	1288013400
		AC400V	50/60Hz	2a2b	1288013500
		AC415V	50/60Hz	2a2b	1288013600
		AC440V	50/60Hz	2a2b	1288013700
		AC500V	50/60Hz	2a2b	1288013800
		AC550V	50/60Hz	2a2b	1288013900
		AC24V	50Hz	2a2b	1288014000
		AC36V	50Hz	2a2b	1288014100
		AC42V	50Hz	2a2b	1288014200
		AC48V	50Hz	2a2b	1288014300
		AC80V	50Hz	2a2b	1288014400
		AC100V	50Hz	2a2b	1288014500
		AC110V	50Hz	2a2b	1288014600
		AC220V	50Hz	2a2b	1288014700
		AC230V	50Hz	2a2b	1288014800
		AC240V	50Hz	2a2b	1288014900
		AC380V	50Hz	2a2b	1288015000
		AC400V	50Hz	2a2b	1288015100
		AC415V	50Hz	2a2b	1288015200
		AC440V	50Hz	2a2b	1288015300
		AC500V	50Hz	2a2b	1288015400
		AC550V	50Hz	2a2b	1288015500
		AC24V	60Hz	2a2b	1288015600
		AC48V	60Hz	2a2b	1288015700
		AC100V	60Hz	2a2b	1288015800
		AC110V	60Hz	2a2b	1288015900
		AC120V	60Hz	2a2b	1288016000
		AC200V	60Hz	2a2b	1288016100
		AC208V	60Hz	2a2b	1288016200
		AC220V	60Hz	2a2b	1288016300
		AC230V	60Hz	2a2b	1288016400
		AC240V	60Hz	2a2b	1288016500
		AC277V	60Hz	2a2b	1288016600
		AC380V	60Hz	2a2b	1288016700
		AC440V	60Hz	2a2b	1288016800
		AC480V	60Hz	2a2b	1288016900
		AC600V	60Hz	2a2b	1288017000
		AC100V, AC110V	50Hz, 60Hz	2a2b	1288017100
		AC110V, AC120V	50Hz, 60Hz	2a2b	1288017200
		AC200V, AC220V	50Hz, 60Hz	2a2b	1288017300
		AC240V, AC277V	50Hz, 60Hz	2a2b	1288017400
DC12V		2a2b	1288017500		
DC20V		2a2b	1288017600		
DC24V		2a2b	1288017700		
DC48V		2a2b	1288017800		
DC60V		2a2b	1288017900		
DC80V		2a2b	1288018000		
DC100V		2a2b	1288018100		
DC110V		2a2b	1288018200		
DC125V		2a2b	1288018300		
DC200V		2a2b	1288018400		
DC220V		2a2b	1288018500		
DC250V		2a2b	1288018600		

Catalogue numbers

Susol

Contactors

MC-40 screw type 2a2b



63AF

Model	Terminal type	Coil voltage	Frequency	Aux.contact	Code
MC-40	Screw	AC24V	50/60Hz	2a2b	1289012500
		AC48V	50/60Hz	2a2b	1289012600
		AC100V	50/60Hz	2a2b	1289012700
		AC110V	50/60Hz	2a2b	1289012800
		AC120V	50/60Hz	2a2b	1289012900
		AC200V	50/60Hz	2a2b	1289013000
		AC220V	50/60Hz	2a2b	1289013100
		AC230V	50/60Hz	2a2b	1289013200
		AC240V	50/60Hz	2a2b	1289013300
		AC380V	50/60Hz	2a2b	1289013400
		AC400V	50/60Hz	2a2b	1289013500
		AC415V	50/60Hz	2a2b	1289013600
		AC440V	50/60Hz	2a2b	1289013700
		AC500V	50/60Hz	2a2b	1289013800
		AC550V	50/60Hz	2a2b	1289013900
		AC24V	50Hz	2a2b	1289014000
		AC36V	50Hz	2a2b	1289014100
		AC42V	50Hz	2a2b	1289014200
		AC48V	50Hz	2a2b	1289014300
		AC80V	50Hz	2a2b	1289014400
		AC100V	50Hz	2a2b	1289014500
		AC110V	50Hz	2a2b	1289014600
		AC220V	50Hz	2a2b	1289014700
		AC230V	50Hz	2a2b	1289014800
		AC240V	50Hz	2a2b	1289014900
		AC380V	50Hz	2a2b	1289015000
		AC400V	50Hz	2a2b	1289015100
		AC415V	50Hz	2a2b	1289015200
		AC440V	50Hz	2a2b	1289015300
		AC500V	50Hz	2a2b	1289015400
		AC550V	50Hz	2a2b	1289015500
		AC24V	60Hz	2a2b	1289015600
		AC48V	60Hz	2a2b	1289015700
		AC100V	60Hz	2a2b	1289015800
		AC110V	60Hz	2a2b	1289015900
		AC120V	60Hz	2a2b	1289016000
		AC200V	60Hz	2a2b	1289016100
		AC208V	60Hz	2a2b	1289016200
		AC220V	60Hz	2a2b	1289016300
		AC230V	60Hz	2a2b	1289016400
		AC240V	60Hz	2a2b	1289016500
		AC277V	60Hz	2a2b	1289016600
		AC380V	60Hz	2a2b	1289016700
		AC440V	60Hz	2a2b	1289016800
		AC480V	60Hz	2a2b	1289016900
		AC600V	60Hz	2a2b	1289017000
		AC100V, AC110V	50Hz, 60Hz	2a2b	1289017100
		AC110V, AC120V	50Hz, 60Hz	2a2b	1289017200
		AC200V, AC220V	50Hz, 60Hz	2a2b	1289017300
		AC240V, AC277V	50Hz, 60Hz	2a2b	1289017400
DC12V		2a2b	1289017500		
DC20V		2a2b	1289017600		
DC24V		2a2b	1289017700		
DC48V		2a2b	1289017800		
DC60V		2a2b	1289017900		
DC80V		2a2b	1289018000		
DC100V		2a2b	1289018100		
DC110V		2a2b	1289018200		
DC125V		2a2b	1289018300		
DC200V		2a2b	1289018400		
DC220V		2a2b	1289018500		
DC250V		2a2b	1289018600		

Catalogue numbers

Susol

Contactors

MC-50 screw type 2a2b



63AF

Model	Terminal type	Coil voltage	Frequency	Aux.contact	Code
MC-50	Screw	AC24V	50/60Hz	2a2b	1290012500
		AC48V	50/60Hz	2a2b	1290012600
		AC100V	50/60Hz	2a2b	1290012700
		AC110V	50/60Hz	2a2b	1290012800
		AC120V	50/60Hz	2a2b	1290012900
		AC200V	50/60Hz	2a2b	1290013000
		AC220V	50/60Hz	2a2b	1290013100
		AC230V	50/60Hz	2a2b	1290013200
		AC240V	50/60Hz	2a2b	1290013300
		AC380V	50/60Hz	2a2b	1290013400
		AC400V	50/60Hz	2a2b	1290013500
		AC415V	50/60Hz	2a2b	1290013600
		AC440V	50/60Hz	2a2b	1290013700
		AC500V	50/60Hz	2a2b	1290013800
		AC550V	50/60Hz	2a2b	1290013900
		AC24V	50Hz	2a2b	1290014000
		AC36V	50Hz	2a2b	1290014100
		AC42V	50Hz	2a2b	1290014200
		AC48V	50Hz	2a2b	1290014300
		AC80V	50Hz	2a2b	1290014400
		AC100V	50Hz	2a2b	1290014500
		AC110V	50Hz	2a2b	1290014600
		AC220V	50Hz	2a2b	1290014700
		AC230V	50Hz	2a2b	1290014800
		AC240V	50Hz	2a2b	1290014900
		AC380V	50Hz	2a2b	1290015000
		AC400V	50Hz	2a2b	1290015100
		AC415V	50Hz	2a2b	1290015200
		AC440V	50Hz	2a2b	1290015300
		AC500V	50Hz	2a2b	1290015400
		AC550V	50Hz	2a2b	1290015500
		AC24V	60Hz	2a2b	1290015600
		AC48V	60Hz	2a2b	1290015700
		AC100V	60Hz	2a2b	1290015800
		AC110V	60Hz	2a2b	1290015900
		AC120V	60Hz	2a2b	1290016000
		AC200V	60Hz	2a2b	1290016100
		AC208V	60Hz	2a2b	1290016200
		AC220V	60Hz	2a2b	1290016300
		AC230V	60Hz	2a2b	1290016400
		AC240V	60Hz	2a2b	1290016500
		AC277V	60Hz	2a2b	1290016600
		AC380V	60Hz	2a2b	1290016700
		AC440V	60Hz	2a2b	1290016800
		AC480V	60Hz	2a2b	1290016900
		AC600V	60Hz	2a2b	1290017000
		AC100V, AC110V	50Hz, 60Hz	2a2b	1290017100
		AC110V, AC120V	50Hz, 60Hz	2a2b	1290017200
		AC200V, AC220V	50Hz, 60Hz	2a2b	1290017300
		AC240V, AC277V	50Hz, 60Hz	2a2b	1290017400
DC12V		2a2b	1290017500		
DC20V		2a2b	1290017600		
DC24V		2a2b	1290017700		
DC48V		2a2b	1290017800		
DC60V		2a2b	1290017900		
DC80V		2a2b	1290018000		
DC100V		2a2b	1290018100		
DC110V		2a2b	1290018200		
DC125V		2a2b	1290018300		
DC200V		2a2b	1290018400		
DC220V		2a2b	1290018500		
DC250V		2a2b	1290018600		

Catalogue numbers

Susol

Contactors

MC-63 screw type 2a2b



63AF

Model	Terminal type	Coil voltage	Frequency	Aux.contact	Code
MC-63	Screw	AC24V	50/60Hz	2a2b	1291012500
		AC48V	50/60Hz	2a2b	1291012600
		AC100V	50/60Hz	2a2b	1291012700
		AC110V	50/60Hz	2a2b	1291012800
		AC120V	50/60Hz	2a2b	1291012900
		AC200V	50/60Hz	2a2b	1291013000
		AC220V	50/60Hz	2a2b	1291013100
		AC230V	50/60Hz	2a2b	1291013200
		AC240V	50/60Hz	2a2b	1291013300
		AC380V	50/60Hz	2a2b	1291013400
		AC400V	50/60Hz	2a2b	1291013500
		AC415V	50/60Hz	2a2b	1291013600
		AC440V	50/60Hz	2a2b	1291013700
		AC500V	50/60Hz	2a2b	1291013800
		AC550V	50/60Hz	2a2b	1291013900
		AC24V	50Hz	2a2b	1291014000
		AC36V	50Hz	2a2b	1291014100
		AC42V	50Hz	2a2b	1291014200
		AC48V	50Hz	2a2b	1291014300
		AC80V	50Hz	2a2b	1291014400
		AC100V	50Hz	2a2b	1291014500
		AC110V	50Hz	2a2b	1291014600
		AC220V	50Hz	2a2b	1291014700
		AC230V	50Hz	2a2b	1291014800
		AC240V	50Hz	2a2b	1291014900
		AC380V	50Hz	2a2b	1291015000
		AC400V	50Hz	2a2b	1291015100
		AC415V	50Hz	2a2b	1291015200
		AC440V	50Hz	2a2b	1291015300
		AC500V	50Hz	2a2b	1291015400
		AC550V	50Hz	2a2b	1291015500
		AC24V	60Hz	2a2b	1291015600
		AC48V	60Hz	2a2b	1291015700
		AC100V	60Hz	2a2b	1291015800
		AC110V	60Hz	2a2b	1291015900
		AC120V	60Hz	2a2b	1291016000
		AC200V	60Hz	2a2b	1291016100
		AC208V	60Hz	2a2b	1291016200
		AC220V	60Hz	2a2b	1291016300
		AC230V	60Hz	2a2b	1291016400
		AC240V	60Hz	2a2b	1291016500
		AC277V	60Hz	2a2b	1291016600
		AC380V	60Hz	2a2b	1291016700
		AC440V	60Hz	2a2b	1291016800
		AC480V	60Hz	2a2b	1291016900
		AC600V	60Hz	2a2b	1291017000
		AC100V, AC110V	50Hz, 60Hz	2a2b	1291017100
		AC110V, AC120V	50Hz, 60Hz	2a2b	1291017200
		AC200V, AC220V	50Hz, 60Hz	2a2b	1291017300
		AC240V, AC277V	50Hz, 60Hz	2a2b	1291017400
DC12V		2a2b	1291017500		
DC20V		2a2b	1291017600		
DC24V		2a2b	1291017700		
DC48V		2a2b	1291017800		
DC60V		2a2b	1291017900		
DC80V		2a2b	1291018000		
DC100V		2a2b	1291018100		
DC110V		2a2b	1291018200		
DC125V		2a2b	1291018300		
DC200V		2a2b	1291018400		
DC220V		2a2b	1291018500		
DC250V		2a2b	1291018600		

Catalogue numbers

Susol

Contactors

MC-65 screw type 2a2b



95AF

Model	Terminal type	Coil voltage	Frequency	Aux.contact	Code
MC-65	Screw	AC24V	50/60Hz	2a2b	1292012500
		AC48V	50/60Hz	2a2b	1292012600
		AC100V	50/60Hz	2a2b	1292012700
		AC110V	50/60Hz	2a2b	1292012800
		AC120V	50/60Hz	2a2b	1292012900
		AC200V	50/60Hz	2a2b	1292013000
		AC220V	50/60Hz	2a2b	1292013100
		AC230V	50/60Hz	2a2b	1292013200
		AC240V	50/60Hz	2a2b	1292013300
		AC380V	50/60Hz	2a2b	1292013400
		AC400V	50/60Hz	2a2b	1292013500
		AC415V	50/60Hz	2a2b	1292013600
		AC440V	50/60Hz	2a2b	1292013700
		AC500V	50/60Hz	2a2b	1292013800
		AC550V	50/60Hz	2a2b	1292013900
		AC24V	50Hz	2a2b	1292014000
		AC36V	50Hz	2a2b	1292014100
		AC42V	50Hz	2a2b	1292014200
		AC48V	50Hz	2a2b	1292014300
		AC80V	50Hz	2a2b	1292014400
		AC100V	50Hz	2a2b	1292014500
		AC110V	50Hz	2a2b	1292014600
		AC220V	50Hz	2a2b	1292014700
		AC230V	50Hz	2a2b	1292014800
		AC240V	50Hz	2a2b	1292014900
		AC380V	50Hz	2a2b	1292015000
		AC400V	50Hz	2a2b	1292015100
		AC415V	50Hz	2a2b	1292015200
		AC440V	50Hz	2a2b	1292015300
		AC500V	50Hz	2a2b	1292015400
		AC550V	50Hz	2a2b	1292015500
		AC24V	60Hz	2a2b	1292015600
		AC48V	60Hz	2a2b	1292015700
		AC100V	60Hz	2a2b	1292015800
		AC110V	60Hz	2a2b	1292015900
		AC120V	60Hz	2a2b	1292016000
		AC200V	60Hz	2a2b	1292016100
		AC208V	60Hz	2a2b	1292016200
		AC220V	60Hz	2a2b	1292016300
		AC230V	60Hz	2a2b	1292016400
		AC240V	60Hz	2a2b	1292016500
		AC277V	60Hz	2a2b	1292016600
		AC380V	60Hz	2a2b	1292016700
		AC440V	60Hz	2a2b	1292016800
		AC480V	60Hz	2a2b	1292016900
		AC600V	60Hz	2a2b	1292017000
AC100V, AC110V	50Hz, 60Hz	2a2b	1292017100		
AC110V, AC120V	50Hz, 60Hz	2a2b	1292017200		
AC200V, AC220V	50Hz, 60Hz	2a2b	1292017300		
AC240V, AC277V	50Hz, 60Hz	2a2b	1292017400		
DC12V		2a2b	1292017500		
DC20V		2a2b	1292017600		
DC24V		2a2b	1292017700		
DC48V		2a2b	1292017800		
DC60V		2a2b	1292017900		
DC80V		2a2b	1292018000		
DC100V		2a2b	1292018100		
DC110V		2a2b	1292018200		
DC125V		2a2b	1292018300		
DC200V		2a2b	1292018400		
DC220V		2a2b	1292018500		
DC250V		2a2b	1292018600		

Catalogue numbers

Susol

Contactors

MC-75 screw type 2a2b



95AF

Model	Terminal type	Coil voltage	Frequency	Aux.contact	Code
MC-75	Screw	AC24V	50/60Hz	2a2b	1293012500
		AC48V	50/60Hz	2a2b	1293012600
		AC100V	50/60Hz	2a2b	1293012700
		AC110V	50/60Hz	2a2b	1293012800
		AC120V	50/60Hz	2a2b	1293012900
		AC200V	50/60Hz	2a2b	1293013000
		AC220V	50/60Hz	2a2b	1293013100
		AC230V	50/60Hz	2a2b	1293013200
		AC240V	50/60Hz	2a2b	1293013300
		AC380V	50/60Hz	2a2b	1293013400
		AC400V	50/60Hz	2a2b	1293013500
		AC415V	50/60Hz	2a2b	1293013600
		AC440V	50/60Hz	2a2b	1293013700
		AC500V	50/60Hz	2a2b	1293013800
		AC550V	50/60Hz	2a2b	1293013900
		AC24V	50Hz	2a2b	1293014000
		AC36V	50Hz	2a2b	1293014100
		AC42V	50Hz	2a2b	1293014200
		AC48V	50Hz	2a2b	1293014300
		AC80V	50Hz	2a2b	1293014400
		AC100V	50Hz	2a2b	1293014500
		AC110V	50Hz	2a2b	1293014600
		AC220V	50Hz	2a2b	1293014700
		AC230V	50Hz	2a2b	1293014800
		AC240V	50Hz	2a2b	1293014900
		AC380V	50Hz	2a2b	1293015000
		AC400V	50Hz	2a2b	1293015100
		AC415V	50Hz	2a2b	1293015200
		AC440V	50Hz	2a2b	1293015300
		AC500V	50Hz	2a2b	1293015400
		AC550V	50Hz	2a2b	1293015500
		AC24V	60Hz	2a2b	1293015600
		AC48V	60Hz	2a2b	1293015700
		AC100V	60Hz	2a2b	1293015800
		AC110V	60Hz	2a2b	1293015900
		AC120V	60Hz	2a2b	1293016000
		AC200V	60Hz	2a2b	1293016100
		AC208V	60Hz	2a2b	1293016200
		AC220V	60Hz	2a2b	1293016300
		AC230V	60Hz	2a2b	1293016400
		AC240V	60Hz	2a2b	1293016500
		AC277V	60Hz	2a2b	1293016600
AC380V	60Hz	2a2b	1293016700		
AC440V	60Hz	2a2b	1293016800		
AC480V	60Hz	2a2b	1293016900		
AC600V	60Hz	2a2b	1293017000		
AC100V, AC110V	50Hz, 60Hz	2a2b	1293017100		
AC110V, AC120V	50Hz, 60Hz	2a2b	1293017200		
AC200V, AC220V	50Hz, 60Hz	2a2b	1293017300		
AC240V, AC277V	50Hz, 60Hz	2a2b	1293017400		
DC12V		2a2b	1293017500		
DC20V		2a2b	1293017600		
DC24V		2a2b	1293017700		
DC48V		2a2b	1293017800		
DC60V		2a2b	1293017900		
DC80V		2a2b	1293018000		
DC100V		2a2b	1293018100		
DC110V		2a2b	1293018200		
DC125V		2a2b	1293018300		
DC200V		2a2b	1293018400		
DC220V		2a2b	1293018500		
DC250V		2a2b	1293018600		

Catalogue numbers

Susol

Contactors

MC-85 screw type 2a2b



95AF

Model	Terminal type	Coil voltage	Frequency	Aux.contact	Code
MC-85	Screw	AC24V	50/60Hz	2a2b	1294012500
		AC48V	50/60Hz	2a2b	1294012600
		AC100V	50/60Hz	2a2b	1294012700
		AC110V	50/60Hz	2a2b	1294012800
		AC120V	50/60Hz	2a2b	1294012900
		AC200V	50/60Hz	2a2b	1294013000
		AC220V	50/60Hz	2a2b	1294013100
		AC230V	50/60Hz	2a2b	1294013200
		AC240V	50/60Hz	2a2b	1294013300
		AC380V	50/60Hz	2a2b	1294013400
		AC400V	50/60Hz	2a2b	1294013500
		AC415V	50/60Hz	2a2b	1294013600
		AC440V	50/60Hz	2a2b	1294013700
		AC500V	50/60Hz	2a2b	1294013800
		AC550V	50/60Hz	2a2b	1294013900
		AC24V	50Hz	2a2b	1294014000
		AC36V	50Hz	2a2b	1294014100
		AC42V	50Hz	2a2b	1294014200
		AC48V	50Hz	2a2b	1294014300
		AC80V	50Hz	2a2b	1294014400
		AC100V	50Hz	2a2b	1294014500
		AC110V	50Hz	2a2b	1294014600
		AC220V	50Hz	2a2b	1294014700
		AC230V	50Hz	2a2b	1294014800
		AC240V	50Hz	2a2b	1294014900
		AC380V	50Hz	2a2b	1294015000
		AC400V	50Hz	2a2b	1294015100
		AC415V	50Hz	2a2b	1294015200
		AC440V	50Hz	2a2b	1294015300
		AC500V	50Hz	2a2b	1294015400
		AC550V	50Hz	2a2b	1294015500
		AC24V	60Hz	2a2b	1294015600
		AC48V	60Hz	2a2b	1294015700
		AC100V	60Hz	2a2b	1294015800
		AC110V	60Hz	2a2b	1294015900
		AC120V	60Hz	2a2b	1294016000
		AC200V	60Hz	2a2b	1294016100
		AC208V	60Hz	2a2b	1294016200
		AC220V	60Hz	2a2b	1294016300
		AC230V	60Hz	2a2b	1294016400
		AC240V	60Hz	2a2b	1294016500
		AC277V	60Hz	2a2b	1294016600
		AC380V	60Hz	2a2b	1294016700
		AC440V	60Hz	2a2b	1294016800
		AC480V	60Hz	2a2b	1294016900
AC600V	60Hz	2a2b	1294017000		
AC100V, AC110V	50Hz, 60Hz	2a2b	1294017100		
AC110V, AC120V	50Hz, 60Hz	2a2b	1294017200		
AC200V, AC220V	50Hz, 60Hz	2a2b	1294017300		
AC240V, AC277V	50Hz, 60Hz	2a2b	1294017400		
DC12V		2a2b	1294017500		
DC20V		2a2b	1294017600		
DC24V		2a2b	1294017700		
DC48V		2a2b	1294017800		
DC60V		2a2b	1294017900		
DC80V		2a2b	1294018000		
DC100V		2a2b	1294018100		
DC110V		2a2b	1294018200		
DC125V		2a2b	1294018300		
DC200V		2a2b	1294018400		
DC220V		2a2b	1294018500		
DC250V		2a2b	1294018600		

Catalogue numbers

Susol

Contactors

MC-95 screw type 2a2b



95AF

Model	Terminal type	Coil voltage	Frequency	Aux.contact	Code
MC-95	Screw	AC24V	50/60Hz	2a2b	1295012500
		AC48V	50/60Hz	2a2b	1295012600
		AC100V	50/60Hz	2a2b	1295012700
		AC110V	50/60Hz	2a2b	1295012800
		AC120V	50/60Hz	2a2b	1295012900
		AC200V	50/60Hz	2a2b	1295013000
		AC220V	50/60Hz	2a2b	1295013100
		AC230V	50/60Hz	2a2b	1295013200
		AC240V	50/60Hz	2a2b	1295013300
		AC380V	50/60Hz	2a2b	1295013400
		AC400V	50/60Hz	2a2b	1295013500
		AC415V	50/60Hz	2a2b	1295013600
		AC440V	50/60Hz	2a2b	1295013700
		AC500V	50/60Hz	2a2b	1295013800
		AC550V	50/60Hz	2a2b	1295013900
		AC24V	50Hz	2a2b	1295014000
		AC36V	50Hz	2a2b	1295014100
		AC42V	50Hz	2a2b	1295014200
		AC48V	50Hz	2a2b	1295014300
		AC80V	50Hz	2a2b	1295014400
		AC100V	50Hz	2a2b	1295014500
		AC110V	50Hz	2a2b	1295014600
		AC220V	50Hz	2a2b	1295014700
		AC230V	50Hz	2a2b	1295014800
		AC240V	50Hz	2a2b	1295014900
		AC380V	50Hz	2a2b	1295015000
		AC400V	50Hz	2a2b	1295015100
		AC415V	50Hz	2a2b	1295015200
		AC440V	50Hz	2a2b	1295015300
		AC500V	50Hz	2a2b	1295015400
		AC550V	50Hz	2a2b	1295015500
		AC24V	60Hz	2a2b	1295015600
		AC48V	60Hz	2a2b	1295015700
		AC100V	60Hz	2a2b	1295015800
		AC110V	60Hz	2a2b	1295015900
		AC120V	60Hz	2a2b	1295016000
		AC200V	60Hz	2a2b	1295016100
		AC208V	60Hz	2a2b	1295016200
		AC220V	60Hz	2a2b	1295016300
		AC230V	60Hz	2a2b	1295016400
		AC240V	60Hz	2a2b	1295016500
		AC277V	60Hz		1295016600
AC380V	60Hz		1295016700		
AC440V	60Hz		1295016800		
AC480V	60Hz		1295016900		
AC600V	60Hz		1295017000		
AC100V, AC110V	50Hz, 60Hz		1295017100		
AC110V, AC120V	50Hz, 60Hz		1295017200		
AC200V, AC220V	50Hz, 60Hz		1295017300		
AC240V, AC277V	50Hz, 60Hz		1295017400		
DC12V			1295017500		
DC20V			1295017600		
DC24V			1295017700		
DC48V			1295017800		
DC60V			1295017900		
DC80V			1295018000		
DC100V			1295018100		
DC110V			1295018200		
DC125V			1295018300		
DC200V			1295018400		
DC220V			1295018500		
DC250V			1295018600		

Catalogue numbers

Susol

Overload relay

MT-32 screw only type



32AF

Model	Terminal type	Rated current(A)	Type	Code
MT-32	Screw only	0.1~0.16	Non-differential(2H)	1296000100
		0.16~0.25	Non-differential(2H)	1296000200
		0.25~0.4	Non-differential(2H)	1296000300
		0.4~0.63	Non-differential(2H)	1296000400
		0.63~1	Non-differential(2H)	1296000500
		1~1.6	Non-differential(2H)	1296000600
		1.6~2.5	Non-differential(2H)	1296000700
		2.5~4	Non-differential(2H)	1296000800
		4~6	Non-differential(2H)	1296000900
		5~8	Non-differential(2H)	1296001000
		6~9	Non-differential(2H)	1296001100
		7~10	Non-differential(2H)	1296001200
		9~13	Non-differential(2H)	1296001300
		12~18	Non-differential(2H)	1296001400
		16~22	Non-differential(2H)	1296001500
		18~25	Non-differential(2H)	1296001600
		22~32	Non-differential(2H)	1296001700
		0.1~0.16	Non-differential(3H)	1297000100
		0.16~0.25	Non-differential(3H)	1297000200
		0.25~0.4	Non-differential(3H)	1297000300
		0.4~0.63	Non-differential(3H)	1297000400
		0.63~1	Non-differential(3H)	1297000500
		1~1.6	Non-differential(3H)	1297000600
		1.6~2.5	Non-differential(3H)	1297000700
		2.5~4	Non-differential(3H)	1297000800
		4~6	Non-differential(3H)	1297000900
		5~8	Non-differential(3H)	1297001000
		6~9	Non-differential(3H)	1297001100
		7~10	Non-differential(3H)	1297001200
		9~13	Non-differential(3H)	1297001300
		12~18	Non-differential(3H)	1297001400
		16~22	Non-differential(3H)	1297001500
		18~25	Non-differential(3H)	1297001600
		22~32	Non-differential(3H)	1297001700
		0.1~0.16	Differential(3K)	1298000100
		0.16~0.25	Differential(3K)	1298000200
		0.25~0.4	Differential(3K)	1298000300
		0.4~0.63	Differential(3K)	1298000400
		0.63~1	Differential(3K)	1298000500
		1~1.6	Differential(3K)	1298000600
		1.6~2.5	Differential(3K)	1298000700
		2.5~4	Differential(3K)	1298000800
		4~6	Differential(3K)	1298000900
		5~8	Differential(3K)	1298001000
		6~9	Differential(3K)	1298001100
		7~10	Differential(3K)	1298001200
		9~13	Differential(3K)	1298001300
		12~18	Differential(3K)	1298001400
16~22	Differential(3K)	1298001500		
18~25	Differential(3K)	1298001600		
22~32	Differential(3K)	1298001700		
1~1.6	Class 20(3D)	1299000100		
1.6~2.5	Class 20(3D)	1299000200		
2.5~4	Class 20(3D)	1299000300		
4~6	Class 20(3D)	1299000400		
5~8	Class 20(3D)	1299000500		
6~9	Class 20(3D)	1299000600		
7~10	Class 20(3D)	1299000700		
9~13	Class 20(3D)	1299000800		
12~18	Class 20(3D)	1299000900		
16~22	Class 20(3D)	1299001000		
18~25	Class 20(3D)	1299001100		
22~32	Class 20(3D)	1299001200		

Catalogue numbers

Susol

Overload relay

MT-63 lug type



63AF

Model	Terminal type	Rated current[A]	Type	Code
MT-63	Lug	4~6	Non-differential(2H)	1300000100
		5~8	Non-differential(2H)	1300000200
		6~9	Non-differential(2H)	1300000300
		7~10	Non-differential(2H)	1300000400
		9~13	Non-differential(2H)	1300000500
		12~18	Non-differential(2H)	1300000600
		16~22	Non-differential(2H)	1300000700
		18~25	Non-differential(2H)	1300000800
		24~36	Non-differential(2H)	1300000900
		28~40	Non-differential(2H)	1300001000
		34~50	Non-differential(2H)	1300001100
		45~65	Non-differential(2H)	1300001200
		4~6	Non-differential(3H)	1301000100
		5~8	Non-differential(3H)	1301000200
		6~9	Non-differential(3H)	1301000300
		7~10	Non-differential(3H)	1301000400
		9~13	Non-differential(3H)	1301000500
		12~18	Non-differential(3H)	1301000600
		16~22	Non-differential(3H)	1301000700
		18~25	Non-differential(3H)	1301000800
		24~36	Non-differential(3H)	1301000900
		28~40	Non-differential(3H)	1301001000
		34~50	Non-differential(3H)	1301001100
		45~65	Non-differential(3H)	1301001200
		4~6	Differential(3K)	1302000100
		5~8	Differential(3K)	1302000200
		6~9	Differential(3K)	1302000300
		7~10	Differential(3K)	1302000400
		9~13	Differential(3K)	1302000500
		12~18	Differential(3K)	1302000600
		16~22	Differential(3K)	1302000700
		18~25	Differential(3K)	1302000800
		24~36	Differential(3K)	1302000900
		28~40	Differential(3K)	1302001000
		34~50	Differential(3K)	1302001100
		45~65	Differential(3K)	1302001200
		4~6	Class 20(3D)	1303000100
		5~8	Class 20(3D)	1303000200
		6~9	Class 20(3D)	1303000300
		7~10	Class 20(3D)	1303000400
		9~13	Class 20(3D)	1303000500
		12~18	Class 20(3D)	1303000600
		16~22	Class 20(3D)	1303000700
		18~25	Class 20(3D)	1303000800
		24~36	Class 20(3D)	1303000900
28~40	Class 20(3D)	1303001000		
34~50	Class 20(3D)	1303001100		
45~65	Class 20(3D)	1303001200		

Catalogue numbers

Susol

Overload relay

MT-95 lug type



95AF

Model	Terminal type	Rated current[A]	Type	Code
MT-95	Lug	7~10	Non-differential(2H)	1304000100
		9~13	Non-differential(2H)	1304000200
		12~18	Non-differential(2H)	1304000300
		16~22	Non-differential(2H)	1304000400
		18~25	Non-differential(2H)	1304000500
		24~36	Non-differential(2H)	1304000600
		28~40	Non-differential(2H)	1304000700
		34~50	Non-differential(2H)	1304000800
		45~65	Non-differential(2H)	1304000900
		54~75	Non-differential(2H)	1304001000
		63~85	Non-differential(2H)	1304001100
		70~95	Non-differential(2H)	1304001200
		7~10	Non-differential(3H)	1305000100
		9~13	Non-differential(3H)	1305000200
		12~18	Non-differential(3H)	1305000300
		16~22	Non-differential(3H)	1305000400
		18~25	Non-differential(3H)	1305000500
		24~36	Non-differential(3H)	1305000600
		28~40	Non-differential(3H)	1305000700
		34~50	Non-differential(3H)	1305000800
		45~65	Non-differential(3H)	1305000900
		54~75	Non-differential(3H)	1305001000
		63~85	Non-differential(3H)	1305001100
		70~95	Non-differential(3H)	1305001200
		7~10	Differential(3K)	1306000100
		9~13	Differential(3K)	1306000200
		12~18	Differential(3K)	1306000300
		16~22	Differential(3K)	1306000400
		18~25	Differential(3K)	1306000500
		24~36	Differential(3K)	1306000600
		28~40	Differential(3K)	1306000700
		34~50	Differential(3K)	1306000800
		45~65	Differential(3K)	1306000900
		54~75	Differential(3K)	1306001000
		63~85	Differential(3K)	1306001100
		70~95	Differential(3K)	1306001200
		7~10	Class 20(3D)	1307000100
		9~13	Class 20(3D)	1307000200
		12~18	Class 20(3D)	1307000300
		16~22	Class 20(3D)	1307000400
		18~25	Class 20(3D)	1307000500
		24~36	Class 20(3D)	1307000600
28~40	Class 20(3D)	1307000700		
34~50	Class 20(3D)	1307000800		
45~65	Class 20(3D)	1307000900		
54~75	Class 20(3D)	1307001000		
63~85	Class 20(3D)	1307001100		
70~95	Class 20(3D)	1307001200		

Catalogue numbers

Susol

Overload relay

MT-63 screw type



63AF

Model	Terminal type	Rated current[A]	Type	Code
MT-63	Screw	4~6	Non-differential(2H)	1308000100
		5~8	Non-differential(2H)	1308000200
		6~9	Non-differential(2H)	1308000300
		7~10	Non-differential(2H)	1308000400
		9~13	Non-differential(2H)	1308000500
		12~18	Non-differential(2H)	1308000600
		16~22	Non-differential(2H)	1308000700
		18~25	Non-differential(2H)	1308000800
		24~36	Non-differential(2H)	1308000900
		28~40	Non-differential(2H)	1308001000
		34~50	Non-differential(2H)	1308001100
		45~65	Non-differential(2H)	1308001200
		4~6	Non-differential(3H)	1309000100
		5~8	Non-differential(3H)	1309000200
		6~9	Non-differential(3H)	1309000300
		7~10	Non-differential(3H)	1309000400
		9~13	Non-differential(3H)	1309000500
		12~18	Non-differential(3H)	1309000600
		16~22	Non-differential(3H)	1309000700
		18~25	Non-differential(3H)	1309000800
		24~36	Non-differential(3H)	1309000900
		28~40	Non-differential(3H)	1309001000
		34~50	Non-differential(3H)	1309001100
		45~65	Non-differential(3H)	1309001200
		4~6	Differential(3K)	1310000100
		5~8	Differential(3K)	1310000200
		6~9	Differential(3K)	1310000300
		7~10	Differential(3K)	1310000400
		9~13	Differential(3K)	1310000500
		12~18	Differential(3K)	1310000600
		16~22	Differential(3K)	1310000700
		18~25	Differential(3K)	1310000800
		24~36	Differential(3K)	1310000900
		28~40	Differential(3K)	1310001000
		34~50	Differential(3K)	1310001100
		45~65	Differential(3K)	1310001200
		4~6	Class 20(3D)	1311000100
		5~8	Class 20(3D)	1311000200
		6~9	Class 20(3D)	1311000300
		7~10	Class 20(3D)	1311000400
		9~13	Class 20(3D)	1311000500
		12~18	Class 20(3D)	1311000600
16~22	Class 20(3D)	1311000700		
18~25	Class 20(3D)	1311000800		
24~36	Class 20(3D)	1311000900		
28~40	Class 20(3D)	1311001000		
34~50	Class 20(3D)	1311001100		
45~65	Class 20(3D)	1311001200		

Catalogue numbers

Susol

Overload relay

MT-95 screw type



95AF

Model	Terminal type	Rated current[A]	Type	Code
MT-95	Screw	7~10	Non-differential(2H)	1312000100
		9~13	Non-differential(2H)	1312000200
		12~18	Non-differential(2H)	1312000300
		16~22	Non-differential(2H)	1312000400
		18~25	Non-differential(2H)	1312000500
		24~36	Non-differential(2H)	1312000600
		28~40	Non-differential(2H)	1312000700
		34~50	Non-differential(2H)	1312000800
		45~65	Non-differential(2H)	1312000900
		54~75	Non-differential(2H)	1312001000
		63~85	Non-differential(2H)	1312001100
		70~95	Non-differential(2H)	1312001200
		7~10	Non-differential(3H)	1313000100
		9~13	Non-differential(3H)	1313000200
		12~18	Non-differential(3H)	1313000300
		16~22	Non-differential(3H)	1313000400
		18~25	Non-differential(3H)	1313000500
		24~36	Non-differential(3H)	1313000600
		28~40	Non-differential(3H)	1313000700
		34~50	Non-differential(3H)	1313000800
		45~65	Non-differential(3H)	1313000900
		54~75	Non-differential(3H)	1313001000
		63~85	Non-differential(3H)	1313001100
		70~95	Non-differential(3H)	1313001200
		7~10	Differential(3K)	1314000100
		9~13	Differential(3K)	1314000200
		12~18	Differential(3K)	1314000300
		16~22	Differential(3K)	1314000400
		18~25	Differential(3K)	1314000500
		24~36	Differential(3K)	1314000600
		28~40	Differential(3K)	1314000700
		34~50	Differential(3K)	1314000800
		45~65	Differential(3K)	1314000900
		54~75	Differential(3K)	1314001000
		63~85	Differential(3K)	1314001100
		70~95	Differential(3K)	1314001200
		7~10	Class 20(3D)	1315000100
		9~13	Class 20(3D)	1315000200
		12~18	Class 20(3D)	1315000300
		16~22	Class 20(3D)	1315000400
		18~25	Class 20(3D)	1315000500
		24~36	Class 20(3D)	1315000600
28~40	Class 20(3D)	1315000700		
34~50	Class 20(3D)	1315000800		
45~65	Class 20(3D)	1315000900		
54~75	Class 20(3D)	1315001000		
63~85	Class 20(3D)	1315001100		
70~95	Class 20(3D)	1315001200		

Catalogue numbers

Susol

Accessories

Direct adapters



Direct adapter

Type	Model	Description	Applied product	Code
Direct adapter	DA-32SA	AC type 32AF(Toggle)	MC-9-32	73311634001
	DA-32HA	AC type 32AF(Rotary)	MC-9-32	73311634002
	DA-32SD	DC type 32AF(Toggle)	MC-9-32	73311634003
	DA-3SHD	DC type 32AF(Rotary)	MC-9-32	73311634004
	DA-63A	AC type 63AF	MC-35-63	73311634005
	DA-63D	DC type 63AF	MC-35-63	73311634006
	DA-95A	AC type 95AF	MC-65-95	73311634007
	DA-95D	DC type 95AF	MC-65-95	73311634008

Surge units



Surge unit

Model	Terminal type	Rated current[A]	Type	Code
Surge unit	US-1	AC24-48V	MC-9-95	83611634001
	US-2	AC100-125V	MC-9-95	83611634002
	US-3	AC200-240V	MC-9-95	83611634003
	US-4	DC24-48V	MC-9-95	83611634004
	US-5	DC100-125V	MC-9-95	83611634005
	US-6	DC200-220V	MC-9-95	83611634006
	US-11	AC/DC24-48V	MC-9-95	83611634007
	US-12	AC/DC100-125V	MC-9-95	83611634008
	US-13	AC/DC200-240V	MC-9-95	83611634009
	US-14	AC380-440V	MC-9-95	83611634010
	US-22	AC100-125V	MC-9-95	83611634011

Catalogue numbers

Susol

Accessories

Interlock units



Interlock unit

Type	Model	Description	Applied product	Code
Interlock unit	UR-02	2NC	MC-9R~95R	83411634001

Aux. contact units



Aux. contact unit

Type	Model	Description	Applied product	Code
Aux. contact unit	UA-1	1NO 1NC	MC-9~95	83361634001
	AU-2	2NO	MC-9~95	83361611028
		1NO 1NC	MC-9~95	83361611030
		2NC	MC-9~95	83361611032
	AU-4	4NO	MC-9~95	83361611054
		3NO1NC	MC-9~95	83361611056
		2NO2NC	MC-9~95	83361611058
		1NO3NC	MC-9~95	83361611060
		4NC	MC-9~95	83361611062

Wire ass'y



Wire ass'y

Type	Model	Description	Applied product	Code
Wire ass'y	UW-32	-	MC-9R~32R	76671631003
	UW-63	-	MC-35R~63R	76671632003
	UW-95	-	MC-65R~95R	76671633003

Catalogue numbers

Susol

Accessories

Remote reset



Remote reset

Type	Model	Description	Applied product	Code
Remote reset	UM-4R	400mm	MT-32-95	84581831001
	UM-5R	500mm	MT-32-95	84581831002
	UM-6R	600mm	MT-32-95	84581831003

Separate mounting adapter

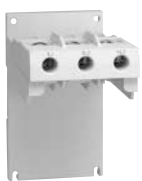

Separate mounting adapter

Type	Model	Description	Applied product	Code
Separate mounting adapter	UZ-32	Screw type	MT-32	83661831001
	UZ-63/S	Screw type	MT-63(Screw type)	83661832002
	UZ-95/S	Screw type	MT-95(Screw type)	83661833002
	UZ-63/L	Lug type	MT-63(Lug type)	83661832001
	UZ-95/L	Lug type	MT-95(Lug type)	83661833001

Capacitor unit



Capacitor unit

Type	Model	Description	Applied product	Code
Capacitor unit	AC-9	-	MC-9-32	83631611001
	AC-50	-	MC-35-95	83631613001

Catalogue numbers

Susol

Manual Motor Starters

32AF



Model	Setting range of thermal trips (A)	IEC Breaking capacity at 415V (kA)	Handle type	Code
MMS-32S	0.1~0.16	100	Toggle	0705003300
	0.16~0.25	100		0705003400
	0.25~0.4	100		0705003500
	0.4~0.63	100		0705003600
	0.63~1	100		0705003700
	1~1.6	100		0705003800
	1.6~2.5	100		0705003900
	2.5~4	100		0705004000
	4~6	100		0705004100
	5~8	100		0705004200
	6~10	50		0705004300
	9~13	50		0705004400
	11~17	20		0705004500
	14~22	15		0705004600
	18~26	15		0705004700
22~32	15	0705004800		
MMS-32H	0.1~0.16	100	Rotary	0705000100
	0.16~0.25	100		0705000200
	0.25~0.4	100		0705000300
	0.4~0.63	100		0705000400
	0.63~1	100		0705000500
	1~1.6	100		0705000600
	1.6~2.5	100		0705000700
	2.5~4	100		0705000800
	4~6	100		0705000900
	5~8	100		0705001000
	6~10	100		0705001100
	9~13	100		0705001200
	11~17	50		0705001300
	14~22	50		0705001400
	18~26	50		0705001500
22~32	50	0705001600		
MMS-32HI	0.16	100	Rotary	0705001700
	0.25	100		0705001800
	4	100		0705001900
	0.63	100		0705002000
	1	100		0705002100
	1.6	100		0705002200
	2.5	100		0705002300
	4	100		0705002400
	6	100		0705002500
	8	100		0705002600
	10	100		0705002700
	13	100		0705002800
	17	50		0705002900
	22	50		0705003000
	26	50		0705003100
32	50	0705003200		

Catalogue numbers

Susol

Manual Motor Starters

63AF



100AF









Model	Setting range of thermal trips (A)	IEC Breaking capacity at 415V (kA)	Handle type	Code
MMS-63S	6~10	100	Rotary	0706000100
	9~13	50		0706000200
	11~17	25		0706000300
	14~22	25		0706000400
	18~26	25		0706000500
	22~32	25		0706000600
	28~40	25		0706000700
	34~50	25		0706000800
	45~63	25		0706000900
MMS-63H	6~10	100	Rotary	0706001000
	9~13	100		0706001100
	11~17	50		0706001200
	14~22	50		0706001300
	18~26	50		0706001400
	22~32	50		0706001500
	28~40	50		0706001600
	34~50	50		0706001700
	45~63	50		0706001800
MMS-63HI	10	100	Rotary	0706001900
	13	100		0706002000
	17	50		0706002100
	22	50		0706002200
	26	50		0706002300
	32	50		0706002400
	40	50		0706002500
	50	50		0706002600
	63	50		0706002700
MMS-100S	11~17	50	Rotary	0707000100
	14~22	50		0707000200
	18~26	50		0707000300
	22~32	50		0707000400
	28~40	50		0707000500
	34~50	50		0707000600
	45~63	50		0707000700
	55~75	50		0707000800
	70~90	50		0707000900
MMS-100H	80~100	50	Rotary	0707001000
	11~17	100		0707001100
	14~22	100		0707001200
	18~26	100		0707001300
	22~32	100		0707001400
	28~40	100		0707001500
	34~50	100		0707001600
	45~63	100		0707001700
	55~75	75		0707001800
MMS-100HI	70~90	75	Rotary	0707001900
	80~100	75		0707002000
	17	100		0707002100
	22	100		0707002200
	26	100		0707002300
	32	100		0707002400
	40	100		0707002500
	50	100		0707002600
	63	100		0707002700
	75	75		0707002800
	90	75		0707002900
	100	75		0707003000

Catalogue numbers

Susol

Accessories(For MMS)

Type	Model	Description	Applied product	Code
Auxiliary switch 	FX	2NO	MMS-32-100	83361941001
		1NO 1NC		83361941002
		2NC		83361941003
	LX	2NO		83361941004
		1NO 1NC		83361941005
		2NC		83361941006
Any trip alarm switch 	LA	2NO (Operates in case of trip)	83011941001	
		1NO 1NC (Operates in case of trip)	83011941002	
		2NC (Operates in case of trip)	83011941003	
Magnetic trip alarm switch 	LAM	2NO (Operates in case of instantaneous trip)	83011941004	
		1NO 1NC (Operates in case of instantaneous trip)	83011941005	
		2NC (Operates in case of instantaneous trip)	83011941006	
Shunt release 	RS	AC24V 50Hz/28V 60Hz	70911941001	
		AC110V 50Hz/120V 60Hz	70911941002	
		AC220~230V 50Hz/240~260V 60Hz	70911941003	
		AC240V 50Hz/277V 60Hz	70911941004	
		AC380~400V 50Hz/440~460V 60Hz	70911941005	
		AC415~440V 50Hz/460~480V 60Hz	70911941006	
		AC200V 50Hz/AC200V~220V 60Hz	70911941020	
Undervoltage release 	RU	AC24V 50Hz/28V 60Hz	83211941001	
		AC110V 50Hz/120V 60Hz	83211941002	
		AC220~230V 50Hz/240~260V 60Hz	83211941003	
		AC240V 50Hz/277V 60Hz	83211941004	
		AC380~400V 50Hz/440~460V 60Hz	83211941005	
		AC415~440V 50Hz/460~480V 60Hz	83211941006	
		AC200V 50Hz/AC200V~220V 60Hz	83211941007	
Undervoltage release with switch 	RUX	AC24V 50Hz/28V 60Hz	83211941021	
		AC110V 50Hz/120V 60Hz	83211941022	
		AC220~230V 50Hz/240~260V 60Hz	83211941023	
		AC240V 50Hz/277V 60Hz	83211941024	
		AC380~400V 50Hz/440~460V 60Hz	83211941025	
		AC415~440V 50Hz/460~480V 60Hz	83211941026	
		AC200V 50Hz/AC200V~220V 60Hz	83211941027	

Catalogue numbers

Susol

Accessories(For MMS)

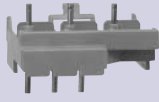
Type	Model	Description	Applied product	Code
	DA-16SA	AC type mini contactor	GMC-6M~16M	73311941001
	DA-16SD	DC type mini contactor	GMD-6M~16M	73311941002
	DA-16HA	AC type mini contactor	GMC-6M~16M	73311941003
	DA-16HD	DC type mini contactor	GMD-6M~16M	73311941004
	DA-32SA	AC type 32AF(Toggle)	MC-9~32	73311634001
	DA-32HA	AC type 32AF(Rotary)	MC-9~32	73311634002
	DA-32SD	DC type 32AF(Toggle)	MC-9~32	73311634003
	DA-32HD	DC type 32AF(Rotary)	MC-9~32	73311634004
	DA-63A	AC type 63AF	MC-35~63	73311634005
	DA-63D	DC type 63AF	MC-35~63	73311634006
	DA-95A	AC type 95AF	MC-65~95	73311634007
	DA-95D	DC type 95AF	MC-65~95	73311634008

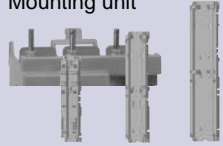
Type	Model	Description	Applied product	Code
	MU-45	45mm width	MMS-32	83661941001
	MU-55	55mm width	MMS-63	83661941011
	MU-70	70mm width	MMS-100	83661941021

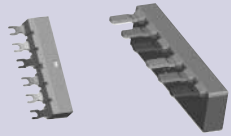
Type	Model	Description	Applied product	Code
	PB-322	Use two of 32AF MMS	MMS-32	70211941201
	PB-632	Use two of 63AF MMS	MMS-63	70211941202

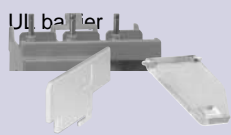
Type	Model	Description	Applied product	Code
	Dial Cover	To protect the setting current	MMS-32~100	64621911009
	UI barrier	Insulation barrier	MMS-100	67221931001

Memo

Susol

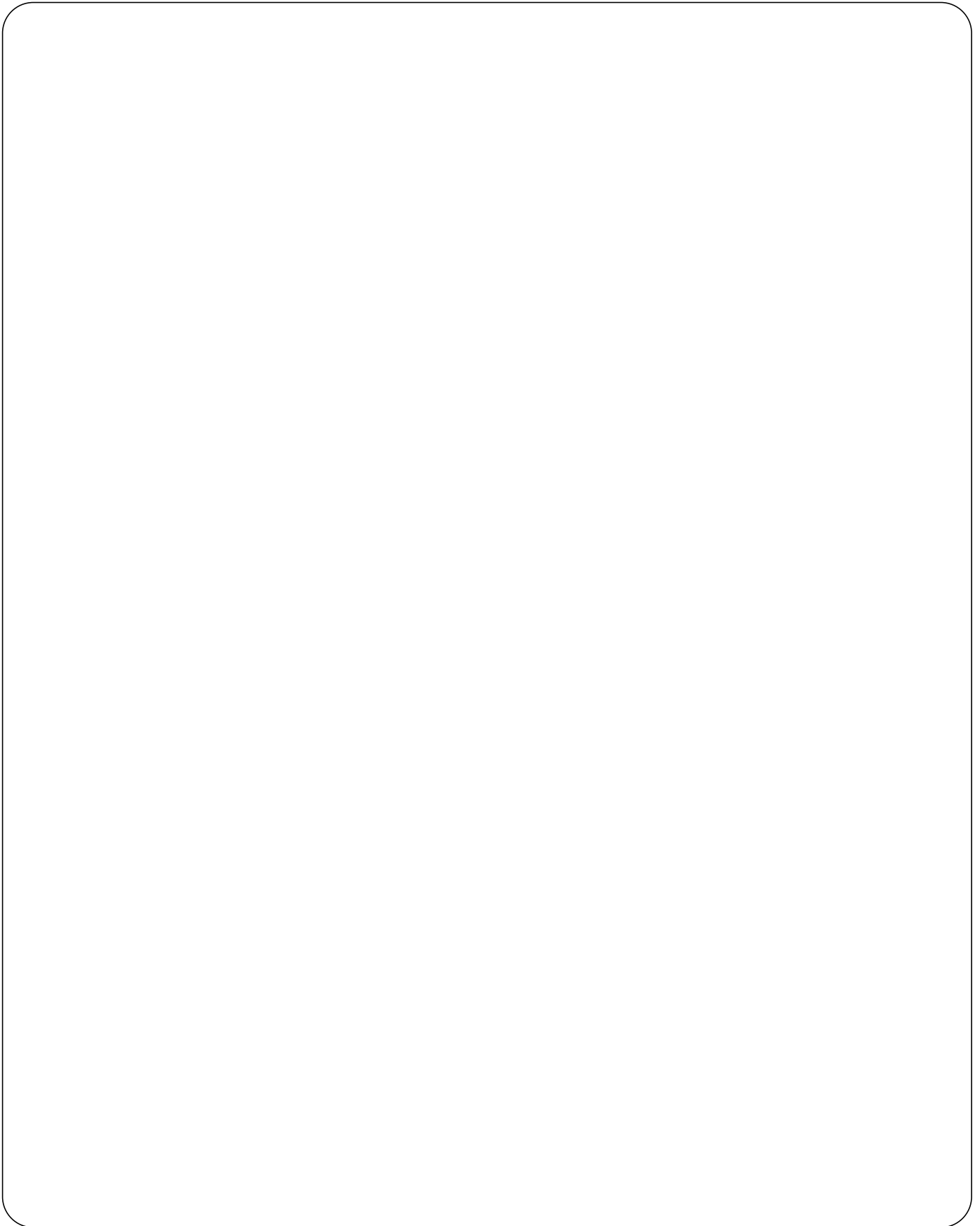

Global Networks

LS Industrial System's global network provides the highest quality of products and services



Tokyo, Japan
LS Industrial Systems Tokyo Office

Dalian, China
Dalian LS Industrial Systems Co.,Ltd

Beijing, China
LS Industrial Systems Beijing Office

Qingdao, China
LS Industrial Systems Qingdao Office

Dubai, U.A.E.
LS Industrial Systems Dubai Rep. Office

Chengdu, China
LS Industrial Systems Chengdu Office

Hanoi, Vietnam
LS-VINA Industrial Systems Co.,Ltd
LS Industrial Systems Hanoi Office

LS Industrial Systems Tokyo Office >> Tokyo, Japan

Address: 16F, Higashi-Kan, Akasaka Twin Towers 17-22, 2-chome, Akasaka, Minato-ku Tokyo 107-8470, Japan

Tel: 81-3-3582-9128 Fax: 81-3-3582-0065 e-mail: dongjins@lisis.biz

LS Industrial Systems Dubai Rep. Office >> Dubai, U.A.E.

Address: P.O.Box-114216, API World Tower, 303B, Sheikh Zayed road, Dubai, UAE.

Tel: 971-4-3328289 Fax: 971-4-3329444 e-mail: hwyim@lisis.biz

LS-VINA Industrial Systems Co., Ltd. >> Hanoi, Vietnam

Address: LSIS VINA Congty che tao may dien Viet-Hung Dong Anh Hanoi, Vietnam

Tel: 84-4-882-0222 Fax: 84-4-882-0220 e-mail: srjo@hn.vnn.vn

LS Industrial Systems Hanoi Office >> Hanoi, Vietnam

Address: Room C21, 5Th Floor, Horison Hotel, 40 Cat Linh , Hanoi, Vietnam

Tel: 84-4-736-6270/1 Fax: 84-4-736-6269

Dalian LS Industrial Systems Co., Ltd. >> Dalian, China

Address: No. 15 Liaohexi 3 Road, Economic and Technical Development zone, Dalian, China

Tel: 86-411-8273-7777 Fax: 86-411-8730-7560 e-mail: lixk@lgis.com.cn

LS Industrial Systems (Wuxi) Co., Ltd. >> Wuxi, China

Address: 102-A National High&New Tech Industrial Development Area, Wuxi, Jiangsu, China

Tel: 86-510-534-6666 Fax: 86-510-522-4078 e-mail: Xuhg@lgis.com.cn

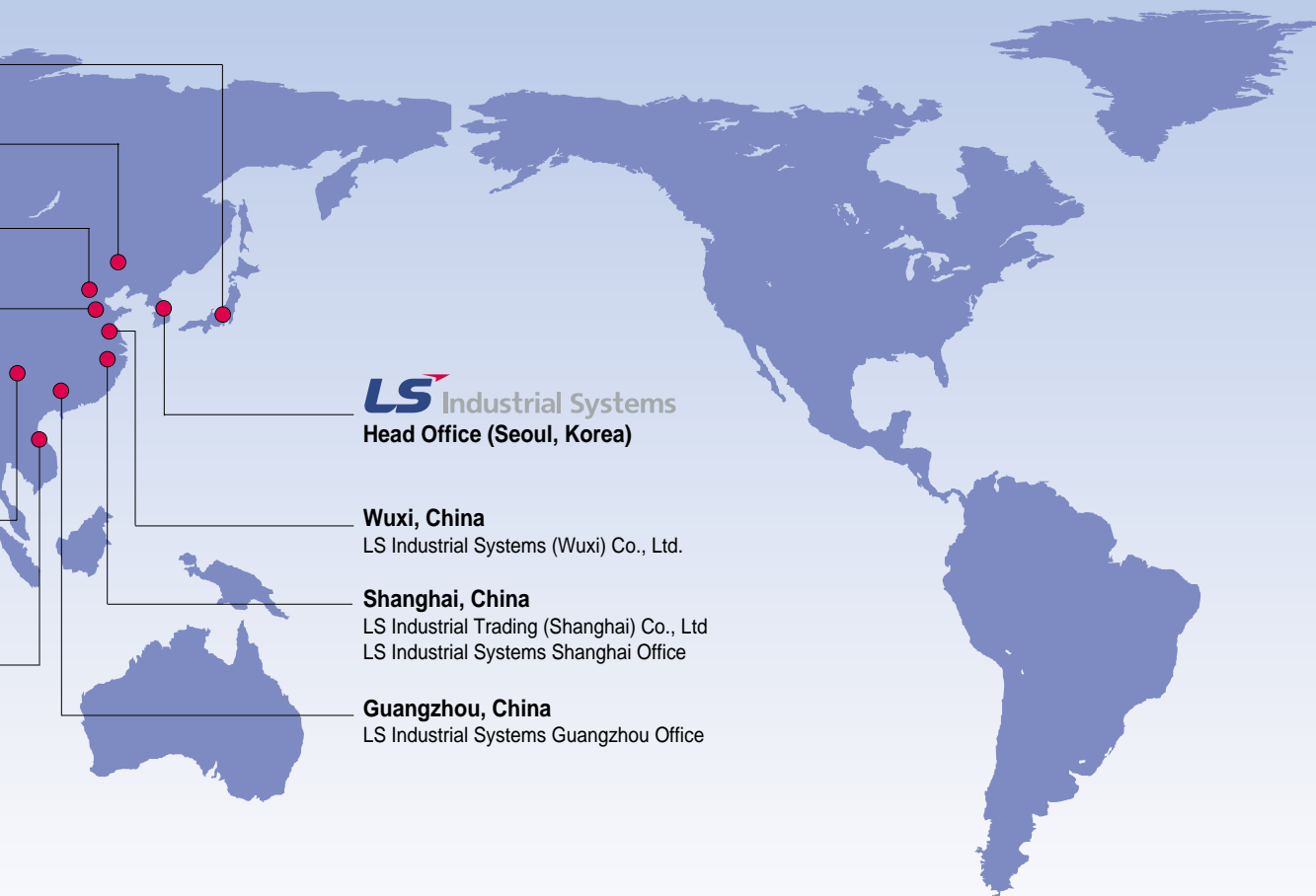

LS Industrial Systems
Head Office (Seoul, Korea)

Wuxi, China
LS Industrial Systems (Wuxi) Co., Ltd.

Shanghai, China
LS Industrial Trading (Shanghai) Co., Ltd
LS Industrial Systems Shanghai Office

Guangzhou, China
LS Industrial Systems Guangzhou Office

LS Industrial Systems International Trading (Shanghai) Co., Ltd. >> Shanghai, China

Address: Room 1705-1707, 17th Floor Xinda Commercial Building No 322,
Xian Xia Road Shanghai, China
Tel: 86-21-6278-4291 Fax: 86-21-6278-4372 e-mail: xuhg@lgis.com.cn

LS Industrial Systems Beijing Office >> Beijing, China

Address: Room 602, North B/D EAS, 21 Xiao Yun Road, Dongsanhuan Beilu,
Chaoyang District Beijing 100027, China
Tel: 86-10-6462-3254 Fax: 86-10-6462-3236 e-mail: linsz@lgis.com.cn

LS Industrial Systems Guangzhou Office >> Guangzhou, China

Address: Room 1403, 14F, New Poly Tower, 2 Zhongshan Liu Road, Guangzhou, China
Tel: 86-20-8326-6754 Fax: 86-20-8326-6287 e-mail: zhangch@lgis.com.cn

LS Industrial Systems Chengdu Office >> Chengdu, China

Address: Room 2907, Zhong Yin B/D, No. 35, RenminZhong(2)-Road, Chengdu, China
Tel: 86-28-8612-9151 Fax: 86-28-8612-9236 e-mail: hongkonk@vip.163.com

LS Industrial Systems Qingdao Office >> Qingdao, China

Address: 7B40, Haixin Guangchang Shenye Building B, No. 9, Shandong Road Qingdao, China
Tel: 86-532-580-2539 Fax: 86-532-583-3793 e-mail: bellkuk@hanmail.net

S u p e r S o l u t i o n

Leader in Electrics & Automation

■ **HEAD OFFICE**

Yonsei Jaedan Severance Bldg. 84-11, 5ga, Namdaemun-ro,
Jung-gu, Seoul 100-753, Korea
Tel. (82-2)2034-4870 Fax. (82-2)2034-4713 <http://www.lsis.biz>

■ **Cheong-Ju Plant**

Cheong-Ju Plant #1, Song Jung Dong, Hung Duk Ku,
Cheong Ju, 361-720, Korea
Tel. (82-43)261-6001 Fax. (82-43)261-6410

Specifications in this catalog are subject to change without notice due to
continuous products development and improvement.

LS Industrial Systems Co., Ltd.